

Yihu! Casting®

专注于首饰铸造
Specializing In Jewelry Casting

熔炼铸造设备及耗材

MELTING/CASTING/MACHINES & CONSUMABLES



提供铸造一站式解决方案
PROVIDE FULL CYCLE CASTING SOLUTION

广州 Guangzhou / 深圳 Shenzhen / 东莞 Dongguan / 义乌 Yiwu / 梧州 Wuzhou / 香港 HongKong / 泰国 Thailand

ABOUT US

关于艺辉

始创于
Since

2003

生产基地
Production Facility

35000m²

资深工程师
Engineers

20+

国家专利
National Patents

100+



艺辉旗下公司 YIHUI GROUP



SAIHUI 赛辉

万协 VANSHAPE

COLDSOAR 冷硕



匠心传承 创新引领

MASTERFUL CRAFTSMANSHIP, PIONEERING INNOVATION

艺辉铸造自2003年成立以来，始终专注于推动中国精密铸造技术行业的创新与发展，作为国内领先的高端首饰铸造设备与整体解决方案供应商，公司凭借持续的自主研发与技术突破，成功打破首饰设备长期被国外垄断的局面，树立了中国精密铸造领域的技术标杆与设备制造典范。

公司构建了涵盖智能铸造设备、自动化研磨抛光系统及配套专用材料的完整产业链体系，拥有超35,000平方米的现代化生产基地，组建了由20余位资深工程师构成的专业研发团队，已获得100多项国家专利。产品畅销全球近150个国家和地区，为全球首饰制造业提供高性能、高稳定性的专业设备与全面技术支持。

技术方面，艺辉不断推进智能铸造与精密工艺的融合创新，在自动化研磨抛光等关键环节达到国际先进水平。在材料领域，公司自主开发的铸造蜡、高端石墨和石英制品等配套材料，为行业提供了一体化的材料解决方案，进一步提升工艺品质与生产效率。

秉承“**客户第一、技术领先、热忱开放、学习拼搏、创新共赢**”的价值观，艺辉建立了符合ISO9001:2015认证的严格质量管理体系，确保从设备制造到售后服务的每一个环节都符合精密铸造的高标准要求。

未来，艺辉将持续加大研发投入，致力于在精密铸造技术领域取得更多突破性专利，扩大国际市场份额。公司将进一步拓展全球服务网络，计划三年内建立更完善的海外代理商体系和供应链布局，为全球客户提供更快捷、更高效、更专业的本地化服务。

公司将重点推进智能制造系统与数智化服务平台建设，集成物联网与大数据技术，为客户提供实时工艺支持与设备运维服务。同时，艺辉将继续深化与国际顶尖供应商的战略协作，共同推动行业工艺升级与技术变革。

艺辉期待与全球伙伴携手，共建协同、高效、可持续的首饰制造产业生态。我们将以创新的技术、卓越的品质和完善的服务，持续为客户创造价值，助力行业迈向智能化、精密化、国际化新阶段。

我们坚信：创新驱动发展，品质赢得未来。艺辉将继续以领先的技术实力与开放的合作精神，与业界同仁共同缔造首饰行业更美好的明天。

Established in 2003, Yihui Casting has consistently dedicated itself to propelling innovation and advancement in China's precision investment casting industry. As a premier domestic supplier of high-end jewelry casting equipment and integrated casting solutions, we have achieved breakthrough innovations through persistent independent R&D, successfully dismantling longstanding international monopolies in jewelry manufacturing equipment and establishing new benchmarks for technological excellence and manufacturing standards in China's precision casting domain.

With a complete industrial chain encompassing intelligent casting machines, auto grinding and polishing systems, and specialized supporting materials and a modern 35,000m² production facility, Yihui Casting leverages its professional R&D team more than 20 engineers and 100 national patents to supply high-performance, reliable equipment and technical support to the global jewelry manufacturing sector across nearly 150 countries.

Technologically, Yihui Casting drives innovation by integrating intelligent casting with precision processes, achieving internationally advanced standards in key areas like automated polishing. In materials science, its proprietary casting waxes, high-grade graphite, and quartz products provide integrated solutions that enhance both quality and manufacturing efficiency for the industry.

Upholding its values of "**Customer First, Technology Leadership, Passion & Openness, Learning & Perseverance, and Innovative Win-Win**," Yihui Casting maintains an ISO 9001:2015 certified quality management system. This guarantees strict adherence to high precision casting standards across all operations—from manufacturing to after-sales support.

Moving forward, Yihui Casting will intensify R&D investment to secure more groundbreaking patents in precision casting and expand its global market share. The company will strategically extend its worldwide service network, planning to establish a more robust overseas distributor system and supply chain layout within three years. This initiative aims to provide global clients with faster, more efficient, and professional localized services.

Yihui Casting will make a strategic emphasis on advancing its intelligent manufacturing systems and digital service platform. This integrated infrastructure, powered by IoT and big data, is designed to provide clients with real-time process support and comprehensive equipment maintenance services. In parallel, Yihui Casting is committed to deepening its strategic alliances with top-tier international suppliers, collaborating to pioneer industry-wide process enhancements and technological evolution.

Yihui Casting looks forward to partnering with global peers to build a more collaborative, efficient, and sustainable ecosystem for the jewelry manufacturing industry. We are committed to creating enduring value for our customers through innovative technology, superior quality, and comprehensive services, driving the industry toward a new era of intelligence, precision, and global integration.

We firmly believe that innovation is the catalyst for progress, and quality is the foundation of the future. With leading technological capabilities and an open, collaborative spirit, Yihui is committed to working with industry peers to forge a brighter tomorrow for the jewelry sector.

发展历程

DEVELOPMENT HISTORY



2003

深圳市艺辉首饰器材有限公司成立
Shenzhen Yihui Jewelry Equipments Co., Ltd established.

2005

广州市艺辉铸造科技有限公司成立
Guangzhou Yihuicasting Technology Co., Ltd established

2008

艺辉香港公司成立，同年广州运营总部设立
Yihui (HK) Ltd. established, together with establishment of Yihuicasting Guangzhou Headquarter

2009

广东瀚辉石墨有限公司成立，专注于石墨石英制品生产
Guangdong Hanhui Graphite Co., Ltd. established, specialize in production of Graphite and ceramic products.

2010

艺辉义乌及东莞长安店开业，同年瑞辉自动化系统（广东）有限公司成立
Under Yihuicasting brand, added a shop in Yiwu city and Changan, Dongguan City separately, in the same year, Yihui Casting Technology Co., Ltd. established.

2011

艺辉深圳求水山店开业，同年艺辉产品远销六十六个国家
Opened a shop in Qiu Shui Shan, Shenzhen City, by this time, our products has been sold to more than 60 countries.

2012

艺辉番禺大罗塘店开业
Celebrated the opening of our shop in Daluotang, Panyu, Guangzhou City.

2013

艺辉深圳李朗旗舰店开业，依托艺辉品牌，已形成石英制品、石墨制品、首饰机械、耗材及工具等完善的精密失蜡铸造产品体系
Opened a flagship store in Lilang, Shenzhen city. Rely on Yihuicasting brand, formed a complete precious lost wax casting products supply system, including ceramic products, graphite products, jewelry machines, consumables, tools, etc.

2014

艺辉广西梧州店和深圳布心店开业；深圳李朗旗舰店成功扩大升级，经营面积达到2000多平方；韬辉科技（佛山）有限公司成立
Guangxi Wuzhou store and Shenzhen Buxin store opened, Shenzhen Li Lang flagship store successfully expand upgrading, operating area has reached 2000 square meter. Taohui Technology (Foshan) Co., Ltd established

2015

Yihui Casting 商标注册成功
Yihui Casting trademark registered successfully.

2016

艺辉深圳横岗店开业
Opened a shop in Henggang, Shenzhen City.

2017

艺辉番禺沙南旗舰店开业，大罗塘店合并至沙南店
Yihui Shan'an flagship shop is opened in Panyu, Daluotang shop merged to Shan'an shop.

2019

安徽驰辉新材料有限公司成立
Anhui Chihui New Materials Co., Ltd established

2022

华智科创中心开始营业
Huazhi Technology Innovation Center set up

2024

艺辉铸造（泰国）有限公司成立
Yihui Casting (Thailand) Co., Ltd established

核心理念

CORE CONCEPT

愿景: 成为全球首饰铸造领域卓越品牌

使命: 秉承工匠精神, 持续创新驱动, 致力于首饰行业的技术进步

价值观: 客户第一, 技术领先, 热忱开放, 学习拼搏, 创新共赢

客户第一: 客户是工作的起点和奋斗方向, 以满足客户的需求, 为所有工作的出发点和落脚点。

技术领先: 技术是企业立身之本, 做市场竞争的领先者, 保持持续领先。

热忱开放: 工作热忱, 个人开放, 积极吸收新鲜事物, 积极拥抱变化, 不故步自封; 团队包容, 吸纳各类人才, 兼容并蓄, 实现自赋能, 自推动, 自优化, 自修复!

学习拼搏: 艺辉人在学习中发现更优秀的自己, 勇于拼搏, 不屈不挠, 勇于担当, 积极进取, 乐于奉献!

创新共赢: 持续创新才能创造更高价值, 利他心, 与客户、员工、供应链、社会共同创造、共享成果与未来。

艺辉不追求短期利益, 在创新、文化、制度、核心竞争力等方面保持持续投入和竞争优势, 实现企业的协调可持续发展。

Vision: To become one of global leading brand in jewelry casting area

Mission: Adhering to the spirit of craftsmanship, driven by continuous innovation, devoted to the technical progress in the jewelry industry

Values: Customer first, leading technology, enthusiasm and openness, learning and hard working, innovation and double win

Customer first: The customer is the starting point and direction of our work in order to meet the needs of various customers, the starting point and foothold for all our works.

Leading technology: Technology is the foundation of Yihucasting, to be the leader in competitive market, as well as to keep constant leading.

Enthusiasm and openness: enthusiasm for work, personal openness, absorb new things and embrace change actively, uncomplacent. team member is inclusive with each other, absorbing all kinds of elites, inclusive and poised mutually, self-empowerment, self-promotion, self-optimization, self-repair!

Learning and hard working: Yihui people shall find better themselves in learning, the courage themselves to hard working, indomitable, positive to take responsibility, proactive, willing to contribute!

Innovation and double win: Constant innovation creates higher value, altruism, and co-create with customers, employees, supply chains. co-creates Society co-creates and shares the fruits and the future and shares the fruits & future together.

Yihucasting does not pursue short-term benefits, meanwhile maintains continuous investment and competitive advantages in innovation, culture, system, core competitiveness, etc., to achieve coordinated and sustainable development of Yihucasting.

Yihu! Casting® 艺辉 | 专注于首饰铸造
Specializing In Jewelry Casting

提供铸造一站式解决方案 PROVIDE FULL CYCLE CASTING SOLUTION

设备 Equipment

3D打印机、压机、注蜡机、搅粉机、电炉、压粉机、石膏清洗机、熔金机、铸造机、铸锭机、抛珠机等。
3D Printer, Vulcanizer, Wax injector, Vacuum mixer, Burnout oven, Cleaning machine, Melting furnace, Casting machine, Gold bar machine, Granulating machine, etc.

工具 and 材料 Tools and Materials

树脂、铸造蜡、硅胶、石膏粉、石墨、石英、工匠台、锤子、剪钳、油槽等。
Resin, Casting wax, Silicone rubber, Investment powder, Graphite, Ceramic, Bench, Hammer, Pliers, Steel trough, etc.

铸造 CASTING

培训 Training

从首饰铸造设计制版开始到制模、注蜡、开粉、焙烧、熔炼铸造等工艺流程全方面技能培训。
Comprehensive training of entire jewelry making process, from 3D design, wax injection, mixing, burning, die casting, continuous casting, granulating, grinding and polishing.

工艺技术 Technics and Technology

我们是专业的失蜡铸造整体解决方案提供商, 拥有整套失蜡铸造工艺流程技术。
Provide full cycle jewelry casting & jewelry polishing solutions.



始于 SINCE **2003** | 珠宝首饰合作工厂 Cooperated Jewelry Factory **5000+** | 合作院校 Cooperated University **1000+**

艺辉对于首饰制造核心理念形成了我们坚定的使命

YIHUI'S CORE PHILOSOPHY OF JEWELRY CASTING HAS FORMED OUR STEADFAST MISSION

卓越的毛坯制备 EXCELLENT RAW PREPARATION

我们坚信，创造卓越的首饰必须始于高品质的毛坯制备。因此，我们深入研究并不断优化整个铸造工艺流程，建立了精密的工艺技术解决方案，以确保毛坯的卓越质量。这一步骤被视为制造卓越产品的不可或缺的基础。

We firmly believe that creating excellent jewelry must start with high-quality raw preparation. Therefore, we have conducted in-depth research and continuously optimized the entire casting process, and established precise process technology solutions to ensure the excellent quality of the blanks. This step is seen as an indispensable foundation for making superior products.

自动化抛光 AUTOMATIC POLISHING

我们重视降低在抛光和研磨等环节的人力资源投入，积极采用自动化设备进行生产。我们专注于提高生产效率，以确保产品的一致性和高品质。这一理念旨在降低成本的同时保持质量，以满足市场需求。

We pay attention to reducing the human resource investment in polishing and grinding, and actively use automated equipment for production. We focus on improving production efficiency to ensure product consistency and high quality. This concept aims to reduce costs while maintaining high quality to meet market demand.



综上所述，我们构建了两个独立的产品线，一个专注于铸造，另一个专注于抛光，结合设备，材料，工艺技术以及培训，以全面推动我们的愿景，为客户提供卓越的首饰制造工艺及技术服务。

In summary, we have built two separate product lines, one specialize in casting and the other in polishing, combining equipment, materials, process technology, and training to fully drive our vision to provide our customers with excellence in jewelry manufacturing Process and technical services.

生产车间 PRODUCTION DEPARTMENT



机械车间 Machinery department



机械车间 Machinery department



石墨车间 Graphite department



旗舰店展厅 Exhibition hall



石墨车间 Graphite department



石英车间 Ceramic department

广泛的应用领域

WIDE RANGE OF APPLICATIONS

我们是专业的失蜡铸造整体解决方案提供商，产品适用于首饰、钟表、眼镜、牙科、琉璃等精密失蜡铸造行业。

Yihuicasting is a professional supplier in providing integrated lost wax casting solutions. Our products are widely used in jewelry, watches, glasses, dental, glaze, and other precision lost wax casting industry.

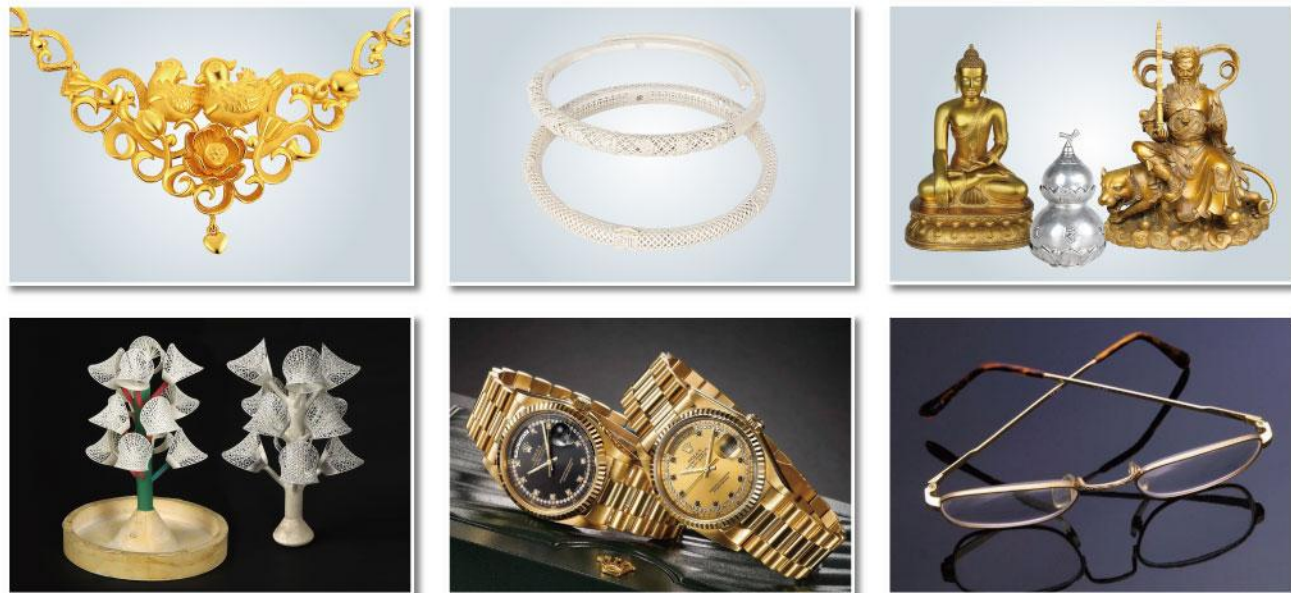

多年来，艺辉铸造科技有限公司向国内外多家知名企业提供了优质的服务，公司生产销售的机器和技术服务受到了外界的一致好评，并与许多知名企业长期合作，共同发展。

Over the years, yihuicasting is linked to several well-known domestic and foreign enterprises to provide a quality service, company production and sales of machinery and technology service gained favorable comment from overea customers,what's more we have build lonterm partner ship with well-knoun partners on a basis of mutual development.

合作企业

Cooperative Enterprise



合作院校

Cooperative School



ISO 9001:2015质量管理体系认证

ISO 9001: 2015 QUALITY MANAGEMENT SYSTEM CERTIFICATION

公司于2014年2月26日顺利通过了SGS质量认证中心的严格审查和认证，获得了ISO 9001:2015质量管理体系认证证书。证书的取得标志着公司质量管理在科学化、精细化、标准化方面又走出了重要的一步，体现了认证机构对我司自主创新、产品质量的肯定，公司在各项管理系统整合上已达到了国际标准，能持续稳定地向顾客提供预期和满意的合格产品。

In February 26, 2014 Yihui passed the strict examination and certification by SGS quality certification center of the ISO, won the 9001:2015 quality management system certification. To obtain the certificate marks the company quality management in a scientific, refinement, standardization and took an important step, the certification body must to our independent innovation, product quality, the company has reached the international standard in the management system integration, can be sustained and stable to provide the customers expectations and satisfaction qualified products.



- 专业:** 专注于首饰铸造，以高品质产品和高素质服务树立行业品牌。
- 敬业:** 坚守首饰铸造产品开发生产多年，科学发展，争当行业排头兵。
- 合作:** 创多元化合作平台，扬长避短，各取所需，共同发展。
- 共赢:** 促进合作，互惠互利，共享发展机遇。

- Profession:** focus on jewelry casting, high-quality products and high-quality service to build up industry brand.
- Devotion:** stick to the jewelry casting product development and production for many years, the scientific development, to become the industry pacesetter.
- Cooperation:** a diversified cooperation platform, strengths promotion and weaknesses prevention, Each party takes what he needs., common development.
- Double-win:** cooperation, mutual reciprocity and mutual benefit, to share the development opportunities.

产品认证证书

PRODUCT CERTIFICATION

公司不断致力于产品的研发与更新，并最大化保证机器的安全与质量。多年来，公司多款产品通过各种质量与安全认证，畅销国内外。

The company is committed to R & D and product, innovation maximize the safety and quality of the machine. Over the years, the company products passed a variety of quality and safety certification, selling at home and abroad.

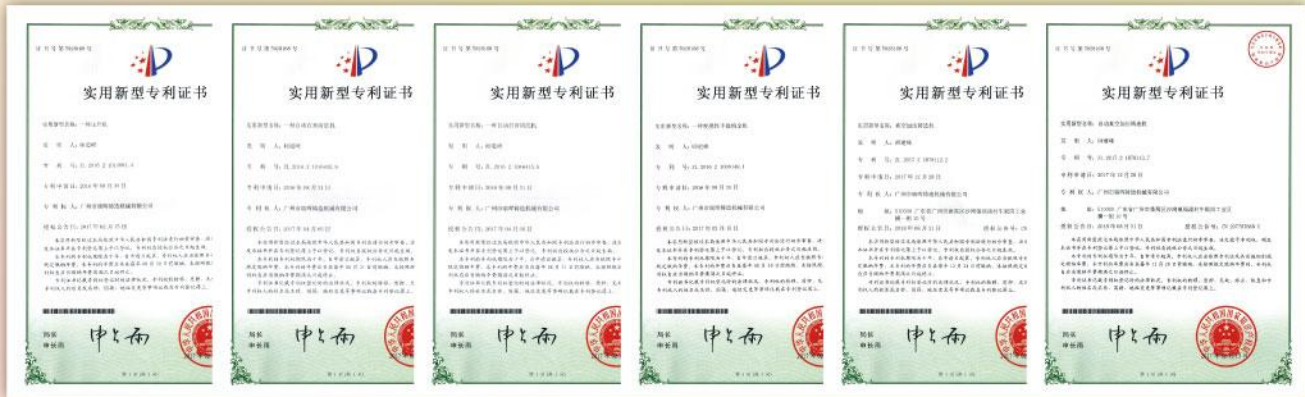

联系我们 CONTACT US

广州市艺辉铸造科技有限公司

地址: 广东省广州市番禺区沙南路50号
电话: +86-20-34734999/34734666/84871666
传真: +86-20-84872122
手机: +86-13802839198
邮箱: info@yihuicasting.com

瑞辉自动化系统(广东)有限公司

地址: 广东省广州市番禺区沙湾镇福涌牛眠岗工业区一街10号
电话: +86-20-34737899 传真: +86-20-34735899
邮箱: info@yihuicasting.com

深圳分公司

地址: 广东省深圳市龙岗区布澜路李朗国际珠宝园A4栋1楼
电话: +86-755-25618858 传真: +86-755-25618859
手机: +86-13824329279
邮箱: sz@yihuicasting.com

深圳横岗店

地址: 深圳横岗六约万利路32号
电话: +86-755-28711600 传真: +86-755-25618859
手机: +86-13808809359

东莞分公司

地址: 广东省东莞市长安镇荣文路74号
手机: +86-13829173566
邮箱: dg@yihuicasting.com

义乌分公司

地址: 浙江省义乌市廿三里街道光耀境26栋
电话: +86-579-85580946 传真: +86-579-85580945
手机: +86-15356942979
邮箱: yw@yihuicasting.com

梧州分公司

地址: 广西梧州市龙圩区龙圩镇西南大道338号3#102铺面
手机: +86-19994612699
邮箱: yhwz@yihuicasting.com

บริษัท ยี่ฮุย คาสติ้ง (ประเทศไทย) จำกัด

1022/218-219 ถนนเจริญนคร แขวงบางลำภูล่าง เขตคลองสาน
กรุงเทพมหานคร 10600
bkk@yihuicasting.com

采购

电话: +86-20-34832586 传真: +86-20-34832585
手机: +86-13802839198
邮箱: buy@yihuicasting.com

售后

电话: +86-20-34832589 传真: +86-20-34832585
手机: +86-13826047512

投诉建议

电话: +86-20-34832589 传真: +86-20-34832585
手机: +86-13802846028
邮箱: tousu@yihuicasting.com

Yihui Casting Technology Co., Ltd

Address: No.50, Shan'an Road, Panyu District, Guangzhou City,
Guangdong Province, China
Tel: +86-20-34734999/34734666/84871666 Fax: +86-20-84872122
Mobile: +86-13802830498 E-mail: info@yihuicasting.com

Ruihui Automation System (Guangdong) Co., Ltd

Address: No.10, First Street, Niuniangang Industrial Park, Fuyong, Shawan
Town, Panyu District, Guangzhou City, Guangdong Province
Tel: +86-20-34737899 Fax: +86-20-34735899 E-mail: info@yihuicasting.com

Shenzhen Branch

Address: First Floor, Building A4, Lilang International Jewelry Industrial Park,
Bulan Road, Longgang District, Shenzhen City, Guangdong Province
Tel: +86-755-25618858 Fax: +86-755-25618859
Mobile: +86-13600183359 E-mail: sz@yihuicasting.com

Shenzhen Henggang Shop

Address: No. 32, Wanli Road, Liugang, Henggang, Shenzhen
Tel: +86-755-28711600 Fax: +86-755-25618859
Mobile: +86-13808809359

Dongguan Branch

Address: No 74 Rongwen Road ChangAn town ,Dongguan City,
Guangdong Province
Mobile: +86-13829173566 E-mail: dg@yihuicasting.com

Yiwu Branch

Address: Building 26, Guangyaojing, Niansanli Street, Yiwu City, Zhejiang Province
Tel: +86-579-85580946 Fax: +86-579-85580945
Mobile: +86-15356942979 E-mail: yw@yihuicasting.com

Wuzhou Branch

Address: 3#102 Store, No. 338, Southwest Road, Longxu Town, Longxu District,
Wuzhou City, Guangxi Province
Mobile: +86-19994612699 E-mail: yhwz@yihuicasting.com

Thailand Branch

Address: 1022/218-219 CharoenNakorn BanglampoolLang Klonsan Bangkok 10600
bkk@yihuicasting.com

Procurement

Tel: +86-20-34832586 Fax: +86-20-34832585
Mobile: +86-13802839198
E-mail: buy@yihuicasting.com

Customer service

Tel: +86-20-34832589 Fax: +86-20-34832585
Mobile: +86-13826047512

Complaints proposals

Tel: +86-20-34832589 Fax: +86-20-34832585
Mobile: +86-13802846028
E-mail: tousu@yihuicasting.com



**设计起板
DESIGN AND MOLDING PREPARATION**

- 01 14K/16K LCD 3D打印机 14K/16K LCD 3D printer
- 04 PRO 3D打印机 PRO 3D printer
- 05 白蜡 3D打印机 White wax 3D printer
- 06 固化箱 Curing box
- 07 树脂 Resin



**制模/注蜡
MOLDING / WAX INJECTION**

- 07 压模机 Vulcanizer
- 08 气动压模机 Pneumatic mould vulcanizer
- 08 胶膜冷冻机 Rubber Cooler
- 09 IW-Plus 真空注蜡机 IW-Plus Vacuum wax injector
- 10 IW-Pro 真空注蜡机 IW-Pro Vacuum wax injector
- 11 IW-6真空注蜡机 IW-6 Vacuum wax injector
- 12 IW-5真空注蜡机 IW-5 Vacuum wax injector
- 13 IW-5ME 真空注蜡机 IW-5ME Vacuum wax injector
- 14 IW-5S 真空注蜡机 IW-5S Vacuum wax injector
- 14 可升降机械手 Movable auto clamp
- 15 蜡镶机 Wax model inlaid stone machine
- 17 金属模注蜡机 Metal mould wax injector
- 17 真空泵 Vacuum pump
- 18 空压机 Air compressor
- 20 电烙铁 Soldering iron
- 21 蜡珠 Wax beads
- 26 水溶蜡 Yihui brand wax



**开粉焙烧
MIX AND BURN**

- 27 1盅不锈钢搅拌机 1Pcs flask vacuum mixer
- 27 3盅不锈钢自动真空搅拌机 3 Pcs flask vacuum mixer
- 28 5盅不锈钢自动真空搅拌机 5 Pcs flask vacuum mixer
- 29 6盅不锈钢自动真空搅拌机 6 Pcs flask vacuum mixer
- 29 10盅不锈钢自动真空搅拌机 10 Pcs flask vacuum mixer
- 30 石膏清洗机 Gypsum cleaning machine
- 31 石膏粉 Investment powder
- 38 电炉 Flask oven



熔炼铸造 Melting and casting

- 41 手熔熔炼炉 MF series melting furnace
- 43 数字熔金炉 Digital Melting Furnace
- 43 迷你熔金机/熔金机 Mini gold melting machine/Gold melting furnace
- 45 臻熔PRO熔金机 Premium-PRO Melting Furnace
- 45 数显熔金机 Digital display gold melting machine
- 46 铂金熔金机 Platinum melting furnace
- 48 倾倒式熔金机 Tilting gold melting machine



- 48 迷你铸造机 Mini casting machine
- 49 吸索铸造机 Suck-type casting machine
- 49 抽真空机 Vacuum mixer
- 50 压粉机 Investment remover
- 51 真空加压铸造机 Vacuum pressure casting machine
- 52 台式迷你铸造机 Mini vacuum pressure casting machine
- 53 自动真空加压铸造机 Automatic vacuum pressure casting machine
- 58 迷你离心旋转铸造机 Mini Centrifugal rotary casting machine
- 59 离心旋转铸造机 Centrifugal rotary casting machine
- 59 离心铸造机 Centrifugal casting machine
- 60 铸锭机 Gold bar machine
- 61 连续铸造机 Continuous casting machine
- 63 甩片机 Gold leaf making machine
- 64 P20水雾化制粉机 P20 water atomised powder making machine
- 65 撒珠机 Threw beads machine
- 69 TMF-R无芯感应熔炼炉系列 TMF-R Coreless induction furnace series
- 71 TVCd真空加压铸造机 TVCd Vacuum pressure casting machine
- 74 铸造用补口 Leghe per microfusione
- 76 工业智能冷水机 Cooling-water machine



石墨石英 Graphite and ceramic

- 83 石墨系列 Graphite series
- 100 涂层坩埚 Coated Crucibles
- 103 石英系列 Ceramic series



焊接 Soldering

- 142 水焊机 Water welding machine
- 143 激光打标机 Optical laser marker
- 146 激光点焊机 Laser welder machine



开料车花 Open material and knurling

- 148 压片机 Rolling mill
- 149 12眼拉线机 12 hole wire drawing machine
- 149 单头焊管机 Tube welding machine
- 150 50吨伺服油压机 50T Servo hydraulic press
- 151 200T油压机 200T Hydraulic press
- 152 退火炉 Annealing oven
- 153 贵金属分析仪 Precious Metal Analyzer

14K/16K LCD 3D打印机
14K/16K LCD 3D printer

专为高品质珠宝生产而设计的超清分辨率LCD 3D打印机，精确度高，打印速度快，实现长期稳定的超大打印能力。

Specially designed for high-quality jewelry production, this ultra clear resolution LCD 3D printer boasts high precision, fast printing speed, and long-term stable ultra large printing capability.

VANSHAPE by **Yihu! Casting®**



首饰设计
Design and molding preparation

技术参数 TECHNICAL INFORMATION

型号 Model	M.PR.VAN70-WAX	M.PR.VAN70-16K
电源 Power Supply	110V/220V 50/60Hz 500W	110V/220V 50/60Hz 500W
打印尺寸 Build Size	L223xW126xH180mm	L211xW118xH180mm
像素 Pixel	13320x5120	15120x6230
打印速度 Build Speed	10+mm/hr 最高50mm/h	10+mm/hr 最高50mm/h
打印厚度 Printing Layer Thickness	0.025-0.1mm	0.025-0.1mm
光源 Light Source	COB 光源 / COB Light Source	COB 光源 / COB Light Source
打印软件 Software	ChituBox	ChituBox
文件格式 File Format	STL、OBJ	STL、OBJ
接口 Connectivity	USB	USB / WIFI
材料 Material	405nm 光敏树脂 405nm Photosensitive Resin	405nm 光敏树脂 405nm Photosensitive Resin
设备尺寸 Machine dimension	L337xW467xH795mm	L337xW467xH795mm
净重 Net weight	43KG	43KG

16K LCD 3D打印机 (Max) 16K LCD 3D printer (Max)

专为佛像、工艺品等大规格产品生产而设计的超清分辨率LCD 3D打印机，精确度高，打印速度快，实现长期稳定的超大打印能力。

Specially designed for the production of large-scale products such as Buddha statues and handicrafts, this ultra clear resolution LCD 3D printer has high precision, fast printing speed, and long-term stable super large printing capacity.

- ✓ 超清分辨率
 - ✓ USB传输 / WiFi
 - ✓ 一键自动生成可编辑支撑
 - ✓ 超大生产能力
- ✓ Ultra clear resolution
 - ✓ USB transmission / WiFi
 - ✓ One click automatic generation of editable support
 - ✓ Ultra large production capacity

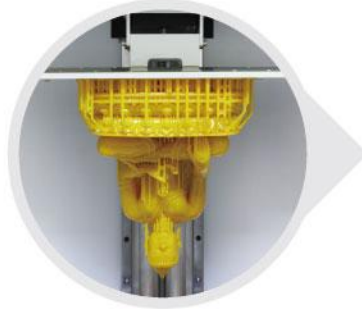

大规格打印
FOR BIG SIZE
BUILD MODEL



设计准备
Design and molding preparation

技术参数 TECHNICAL INFORMATION

型号 Model	M.PR.VAN90-WAX
电源 Power Supply	110V/220V 50/60Hz 700W
打印尺寸 Build Size	L302xW161xH400mm
像素 Pixel	15120x6230
XY分辨率 XY Resolution	20×26μm
打印速度 Build Speed	2~3 层/秒 / 2-3 Layer/s
打印层厚 Printing Layer Thickness	0.025-0.1mm
投影光源 Projection light source	LCD
文件格式 File Format	STL
接口 Connectivity	USB / WIFI
固化波长 Curing wavelength	405nm
材料 Material	光敏树脂 Photosensitive Resin
设备尺寸 Machine dimension	L650×W385×H1500mm

16K LCD 3D打印机 (自动进料) 16K LCD 3D Printer (Automatic feeding)

专为高品质珠宝生产而设计的超清分辨率，XY像素精度突破到19um，Z轴双导轨滚珠丝杆精度0.0125mm，更是让每一个曝光细节表现的淋漓尽致，打印模型高度还原，更加逼真。

Specially designed for high-quality jewelry production, the ultra clear resolution has broken through 19um in XY pixel accuracy and 0.0125mm in Z-axis double guide ball screw accuracy, allowing every exposure detail to be fully displayed. The printed model is highly restored and more realistic.

- ✓ 自动进料系统
- ✓ 断电续打
- ✓ 双导轨滚珠丝杆
- ✓ Automatic feeding system
- ✓ Power off and continue to operate
- ✓ Double guide ball screw



Design and molding preparation

技术参数 TECHNICAL INFORMATION

型号 Model	M.PR.FluxCore
电源 Power Supply	110V/220V 50/60Hz
功率 Power input	350W
XY像素精度 XY Pixel accuracy	19um
分辨率 Resolution	15120×6230
Z轴 Z-axis	双导轨滚珠丝杆0.0125mm
固化波长 Curing wavelength	405nm
打印尺寸 Build Size	211×118×150mm
打印速度 Build Speed	60-100mm/H
打印层厚 Printing Layer Thickness	0.025-0.1mm
数据传输 Data transmission	局域网 LAN / USB / WIFI
断电续打 Power off continuation	支持 Supported
设备尺寸 Machine dimension	700×700×830mm

PRO 3D打印机 PRO 3D printer

PRO系列是一款采用高分辨率DLP光固化技术、专门为珠宝首饰行业开发的3D打印机，具有高精度、大打印尺寸和高生产效率的特点，主要用于珠宝首饰行业母模制作、客户定制设计、展示模型、直接精铸、热/冷压模和批量生产等。自主研发的系统，更快的切片速度、脱机打印、自主更新，7英寸全彩触屏，领先的操作控制，PRO系列3D打印机具有易用、运行可靠、打印工件精度高、配套耗材成本低等。

Ruby series adopt DLP light curing technology of high resolution, specially designed for jewelry industry, mainly used for masterpiece making, DIY jewelry design, jewelry casting, hot/cold mold vulcanizing and quantity production. Independent R&D system, faster slicing speed off-line printing, upgrade periodically. 7 inch fullcolor touchscreen, leading operating control system. Ruby 100 has advantage of high accuracy, large printing area, high working efficiency, stable working, low cost of working consumables.



新创华莎
Design and molding preparation

技术参数 TECHNICAL INFORMATION

型号 Model	M.PR.PRO100	M.PR.PRO200
电源 Power Supply	110V/220V 50/60Hz 500W	110V/220V 50/60Hz 500W
像素 Pixel	1280×800	1920×1080
打印尺寸 Build Size	L64×W40×H80mm	L144×W81×H170mm
打印速度 Build Speed	10+ mm/hr	10+ mm/hr
打印厚度 Printing Layer Thickness	25-50μm	25-50μm
光源 Light Source	工业 UV LED 405nm / Industrial UV LED 405nm	工业 UV LED 405nm / Industrial UV LED 405nm
打印软件 Software	3DPrint Slicer	3DPrint Slicer
文件格式 File Format	YXP	YXP
接口 Connectivity	USB / WIFI	USB / WIFI
材料 Material	DLP树脂 / DLP resin	DLP树脂 / DLP resin
机器尺寸 Machine size	L337×W467×H795mm	L359×W497×H956mm
净重 Net weight	45KG	58KG

白蜡 3D打印机 White wax 3D printer

白蜡采用透氧薄膜结构，打印过程氧气参与固化过程，离型力非常小，因此打印速度可以很快，同时材料含蜡量大幅度提升，铸造性能优越。摆脱了铸造难的困扰。

3D wax printer adopts oxygen-permeable film, with weak release force. Oxygen gets involved in curing resin in the process of printing. Such a working principle deliver fast printing. Meanwhile, with the improved wax content, the special materials features excellent casting performance, making casting much easier.

相对于传统铸造树脂优势： COMPARED TO TRADITIONAL CASTING RESIN, IT HAS THE FOLLOWING ADVANTAGES:

- 1 打印速度快（速度2倍）
Fast printing speed (2times as fast as normal casting resin)
- 2 表面光滑度高
Printed models are more smooth on the surface
- 3 非常容易铸造，适合金货的生产
Easy to cast, suitable for producing products made from gold



技术参数 TECHNICAL INFORMATION

型号 Model	M.PR.Pro150-wax
电源 Power Supply	110V/220V 50/60Hz 500W
像素尺寸 Pixel Size X, Y	50μm
X, Y 分辨率 X, Y Resolution	1920×1080P
打印尺寸 Build Size	L96×W54×H130mm
打印速度 Build Speed	10+ mm/hr
打印层厚 Printing Layer Thickness	10-50μm
光源 Light Source	工业 UV LED 405nm / Industrial UV LED 405nm
打印软件 Software	V2.0 for Windows 7
文件格式 File Format	SLC
光机 Optical machine	美国进口DMD芯片光源 US imported chip light source
文件传输 File transfer	USB
材料 Material	白蜡 White wax
机器尺寸 Machine size	L337×W467×H795mm
净重 Net weight	45KG

固化箱 Curing box



技术参数 TECHNICAL INFORMATION

型号 Model	CB-CURECUBE
固化尺寸 Curing size	400×400×400mm
固化波长 Curing wavelength	405nm
固化功率 Curing power	120W
加热功率 Heating power	80W
整机功率 Total power	200W
输入电源 Input power	100-240VAC; 50-60Hz
产品尺寸 Product size	445×445×515mm
机器重量 Product weight	20Kg
包装外尺寸 Outer dimensions of packaging	520×520×615mm



技术参数 TECHNICAL INFORMATION

型号 Model	M.PR.PRO14
固化时间 Curing time	1-30分钟 / 1-30 minutes
固化光源 Curing light source	顶部灯板405nm / 405nm light board
功率 Power	100w
输入电压 Input voltage	100~240v 50/60Hz DC 24V
重量 Weight	6KG
内腔尺寸 Lumen size	L180×W180×H100mm
机器尺寸 Machine size	L220×W220×H325mm

新设计
Design and molding preparation



树脂 Resin



技术参数 TECHNICAL INFORMATION

型号 Model	RS-ALBINO	RS-OBSIDIAN	RS-AURORA	RS-OLIVE
密度 Density	1.06g-1.075g/cm ³	1.07g-1.1g/cm ³	1.07g-1.1g/cm ³	1.07g-1.1g/cm ³
粘度 Viscosity	450-550cps	250cps-350cps	250cps-350cps	1500cps-2000cps
层曝光时间 Exposure time	5.5s-6.5s	3.5s-5.5s	3.5s-5.5s	5.5s-6.5s
底层曝光时间 Bottom exposure time	30s-40s	15s-25s	15s-25s	40s
颜色 Color	半透明黄色，清洗并固化后为奶白色 Yellow, after curing become white	半透明黑色 Semi-transparent black	橙色 Orange	绿色 Green

应用行业

适用珠宝行业，齿科，教学科研，玩具设计，工艺品设计，工业零件设计等。

APPLICATION INDUSTRY

Suitable for jewelry, dentistry, education and scientific research, toy design, handicraft design, industrial part design



双温控数显压模机 Double-controller digital vulcanizer

产品特点 PRODUCT FEATURES

- 1、上下发热板独立数字化温控，触屏式功能设定，温度更精准。
- 2、铸铝发热板，寿命更长。
- 3、压模铝板全氧化喷砂处理，强度更好，更耐用。

1. Both up and down heating plate are under digital control, touch screen function set, more accurate temp display.
2. Aluminum heating plate helps prolong machine's life time.
3. Sand blasting heating plate, strong and durable.

技术参数 TECHNICAL PARAMETERS

型号 Model: M.YM.N0200-A / M.YM.N0200-B
 电源 Power supply: 110V, 60Hz / 220V, 50Hz
 机器总功率 Input power: 900W
 机器工作温度 Temp display range: 0-200°C
 机器工作台面尺寸 Working table size: L200×W200mm
 机器外形最大尺寸 Machine size: L454×W290×H592
 净重 Weight: 50kg

气动压模机
Pneumatic mould vulcanizer

产品特点

压模压力全自动控制，无需人工不断加压，压力更准确；全程压模位置闭环监控。

PRODUCT FEATURES

Fully automatic control system to control vulcanizing pressure, no need manual working, improved pressure accuracy during vulcanizing process. The whole process is monitored to the vulcanizing position.

技术参数 TECHNICAL PARAMETERS

型号 Model: M.YM.YM-200
电压 Voltage: 220V, 50HZ
功率 Power: 1KW
压模尺寸 Mould size: 200x200x100mm
气压 Pressure: 0.8MPa
温度范围 Temperature Range: 20-200°C
外形尺寸 Outer size: Φ405x595mm
重量 Weight: 68KG



胶膜冷冻机
Rubber Cooler

型号 Model	M.WI.CO-550-Z
功率 Power input	650w
噪音 noise	无 Nothing
制冷面积 Refrigeration area	550X160mm
制冷温度 Refrigeration temperature	5°C-15°C
制冷方式 Refrigeration mode	环保冷媒压缩机制冷 Compression refrigerator
组网方式 Networking mode	可一台主机拖多个 One host can drag multiple



制模操作流程
Vulcanizing operation



1、剪切硅胶/橡胶，先填一层至压模框中，然后放入需制作的模版，最后完全填充硅胶并充分压实。
1. Cut silicone rubber into sheets, fill one rubber sheet into aluminum mould frame, then add metal mold, finally put rest rubber sheet and press them powerfully in order to wrap the mold closely.



2、预热压模机并设置好相关参数。
2. Preheat vulcanizer and set parameters.



3、将压模框置入上下发热板之间，转动压力圈进行压模，并尽可能大力地旋紧。
3. Place the mould frame on heating panel, turn the handle as possible to press rubber mold.



4、硅胶/橡胶硫化时间达到之后旋开压力圈并取出压模框，将压好的硅胶模挤出。
4. When set time is up, turn back the handle and take out aluminum frame mould, then squeeze out vulcanized rubber mould.



5、待硅胶模/橡胶模完全冷却后即可开胶模，开模时先取出压模珠，然后再用小刀逐步剖开。
5. When rubber molds get cool, take out metal locks, then use blade to cut rubber mold slowly and carefully.



6、完全剖开硅胶模，将硅胶模一分为二并取出模板，制模完成。
6. After finish rubber cutting, open rubber into 2 parts and take out metal mold to finish rubber mold making process.

IW-Plus 真空注蜡机 IW-Plus Vacuum wax injector

产品特点:

- 1、蜡缸压力、真空压力在触控屏上显示;
- 2、1000组程序参数在触控屏上设置;
- 3、通过射频感应卡,快速调用程序参数;
- 4、一键排气与排蜡;
- 5、整体设计占位小

技术参数:

电源: 单相 AC 220V±10%, 50/60Hz
功率: 500W
保险丝规格: 5A/250V
蜡缸加热温度范围: 0-95°C
蜡嘴加热温度范围: 0-95°C
真空定时范围: 0-99.9S
注蜡定时范围: 0-99.9S
蜡缸容量: 3kg
蜡缸设置压力: <200KPa
夹具升降方式: 手动调节
尺寸: L580×W305×D445mm

真空泵 Vacuum pump

技术参数:

电源: 单相 AC 220V±10%, 50/60Hz
功率: 120W
最大真空压: -100KPa
抽气速率: 1.2L/S
加油量: 160ML

PRODUCT FEATURES:

1. Pressure value of wax chamber and vacuum is shown on touch screens.
2. 1000 groups of programs are shown on touch screens.
3. The parameters in programs are quickly called through radio frequency induction card.
4. Gas and wax exhaust can be finished through one key.
5. Small-size design for the machine covering smaller areas.

TECHNICAL PARAMETERS:

Voltage: Single phase AC 220V±10%, 50/60Hz
Power: 500W
Fuse specifications: 5A/250V
Heating temperature range of wax bath: 0-95°C
Wax nozzle heating temperature range: 0-95°C
Vacuum timing range: 0-99.9S
Wax injection timing range: 0-99.9S
Wax tank capacity: 3kg
Wax tank setting pressure: <200KPa
The movement of clamps: manually adjustable
Size: L580×W305×D445mm

TECHNICAL PARAMETERS:

Voltage: Single phase AC 220V±10%, 50/60Hz
Power: 120W
Maximum vacuum pressure: -100KPa
Pumping rate: 1.2L/S
The amount of oil: 160ML



蜡缸顶盖部件
Accessories for wax chamber lid



操控面板
Operation panel



可升降机械手
Movable auto clamp



真空泵
Vacuum pump

IW-Pro真空注蜡机 IW-Pro Vacuum wax injector

产品特点:

1. 控制器与注蜡机箱分体隔热，全贴合技术；
2. 一千组程序预设；
3. RF射频感应，升降电机；
4. 温控精度 $\pm 0.1^{\circ}\text{C}$ ；
5. 99%注蜡成功率，一键排气排蜡功能，数字气压表。

技术参数:

电源：单相 AC 220V $\pm 10\%$ ，50/60HZ
 功率：500W
 保险丝规格：5A/250V
 蜡缸加热温度范围：0-95 $^{\circ}\text{C}$
 蜡嘴加热温度范围：0-95 $^{\circ}\text{C}$
 真空定时范围：0-99S
 注蜡定时范围：0-99S
 蜡缸容量：3Kg
 蜡缸设置压力：<200KPa

真空泵 Vacuum pump

技术参数:

电源：单相 AC 220V $\pm 10\%$ ，50/60Hz
 功率：120W
 最大真空压：-100KPa
 抽气速率：1.2L/S
 加油量：160ML

PRODUCT FEATURES:

1. Separated control box from wax injection unit for better heating insulation;
2. One thousand program presets;
3. RF shooting screen induction, lifting motor;
4. Temperature control accuracy $\pm 0.1^{\circ}\text{C}$;
5. 99% wax injection success rate, one-key exhaust and wax discharge function, digital barometer.

TECHNICAL PARAMETERS:

Voltage: Single phase AC 220V $\pm 10\%$, 50/60HZ
 Power: 500W
 Fuse specifications: 5A/250V
 Heating temperature range of wax bath: 0-95 $^{\circ}\text{C}$
 Wax nozzle heating temperature range: 0-95 $^{\circ}\text{C}$
 Vacuum timing range: 0-99S
 Wax injection timing range: 0-99S
 Wax tank capacity: 3kg
 Wax tank setting pressure: <200KPa

TECHNICAL PARAMETERS:

Voltage: Single phase AC 220V $\pm 10\%$, 50/60Hz
 Power: 120W
 Maximum vacuum pressure: -100KPa
 Pumping rate: 1.2L/S
 The amount of oil: 160ML

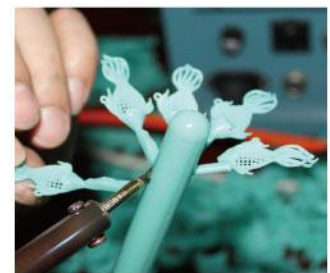

蜡注
Wax injection



蜡缸顶盖部件
Accessories for wax chamber lid



控制箱
Control box



可升降机械手
Movable auto clamp



真空泵
Vacuum pump

IW-6A真空注蜡机 IW-6A Vacuum wax injector

产品特点:

工业品牌, 气压稳定, 控温精准, 操作稳定, 配有手动升降夹具, 一线品牌零部件。

技术参数:

电源: 单相 AC 220V±10%, 50/60Hz
功率: 500W
保险丝规格: 5A/250V
蜡缸加热温度范围: 55-85°C (±0.1°C)
蜡嘴加热温度范围: 55-85°C (±0.1°C)
真空定时范围: 0-20S
注蜡定时范围: 0-25.5S
蜡缸容量: 3Kg
外型尺寸: L527×W294×D506mm
重量: 21kg

存储参数组: 10组一键模式 + 1组非一键模式

PRODUCT FEATURES:

Industrial brand, stable air pressure, accurate temperature control, stable operation, equipped with hand lift clamp, components from first-line brand.

TECHNICAL PARAMETERS:

Voltage: Single phase, 220V±10%, 50/60Hz
Power: 500W
Fuse specifications: 5A/250V
Heating temperature range of wax bath: 55-85°C (±0.1°C)
Wax nozzle heating temperature range: 55-85°C (±0.1°C)
Vacuum timing range: 0-20S
Wax injection timing range: 0-25.5S
Wax tank capacity: 3kg
Dimensions: L527×W294×D506mm
Weight: 21kg

STORAGE PARAMETER GROUP: 10 GROUPS OF ONE-KEY MODE + 1 GROUP OF NON-ONE-KEY MODE

真空泵 Vacuum pump

技术参数:

电源: 单相 AC 220V±10%, 50/60Hz
功率: 120W
最大真空压力: 100KPA
抽气速率: 1.2L/S
加油量: 160ML

TECHNICAL PARAMETERS:

Power supply: Single phase AC 220V±10%, 50/60Hz
Power: 120W
Maximum vacuum pressure: 100KPA
Pumping rate: 1.2 L/S
The amount of oil: 160ML



蜡缸顶盖部件
Accessories for wax chamber lid



操控面板
Operation panel



可升降机械手
Movable auto clamp



真空泵
Vacuum pump

IW-5真空注蜡机 IW-5 Vacuum wax injector

产品特点:

工业品牌, 气压稳定, 控温精准, 操作稳定, 配有手动升降夹具, 一线品牌零部件。

技术参数:

电源: 单相 AC 220V±10% 50/60HZ
功率: 500W
保险丝规格: 5A/250V
蜡缸加热温度范围: 55-85°C (±0.1°C)
蜡嘴加热温度范围: 55-85°C (±0.1°C)
真空定时范围: 0-12S (±0.1s)
注蜡定时范围: 0-12S (±0.1s)
蜡缸容量: 3Kg
外型尺寸: L438×W312×D506
重量: 19kg

IW-5控制箱 IW-5 Control box

技术参数:

外部气压: 0.4-0.7MPa
调节阀设定气压: 0.4MPa
第一次注射压力: <256KPa
第二次注射压力: <256KPa
再次启动时间: 建议<0.5S, 不需要二次加压, 设置为0
夹具压模气压: <256KPa
夹具推模气压: <256KPa
压模延时: <256S
最大工件数: 999999
存储参数组: 10组一键模式 + 1组非一键模式

真空泵 Vacuum pump

技术参数:

电源: 单相 AC 220V±10%, 50/60Hz
功率: 120W
最大真空压力: 100KPa
抽气速率: 1.2L/S
加油量: 160ML

PRODUCT FEATURES:

Industrial brand, stable air pressure, accurate temperature control, stable operation, equipped with hand lift clamp, components from first-line brand.

Technical parameters:

Voltage: Single phase, 220V±10% 50/60HZ
Power: 500W
Fuse specifications: 5A/250V
Heating temperature range of wax bath: 55-85°C (±0.1°C)
Wax nozzle heating temperature range: 55-85°C (±0.1°C)
Vacuum timing range: 0-12S (±0.1s)
Wax injection timing range: 0-12S (±0.1s)
Wax tank capacity: 3kg
Dimensions: L438×W312×D506
Weight: 19kg

TECHNICAL PARAMETERS:

External air pressure: 0.4-0.7MPa
Setting air pressure of pressure regulating valve: 0.4MPa
Press 1: <256KPa
Press 2: <256KPa
Timing for P.2: It is recommended to <0.5S, no need to pressurizetwice, set to 0.
Air pressure of fixture compression mould: <256KPa
Pressure of fixture pushing mold: <256KPa
Hold time: <256S
Maximum number of work pieces: 999999
Storage parameter group: 10 groups of one-key mode + 1 group of non-one-key mode

TECHNICAL PARAMETERS:

Power supply: Single phase AC 220V±10%, 50/60Hz
Power: 120W
Maximum vacuum pressure: 100KPa
Pumping rate: 1.2 L/S
The amount of oil: 160ML



蜡缸顶盖部件
Accessories for wax chamber lid



操控面板
Operation panel



可升降机械手
Movable auto clamp



机械手控制器
Controller of Clamp

IW-5ME 真空注蜡机 IW-5ME Vacuum wax injector

产品特点:

- 1、数字化设置与显示蜡缸温度、蜡嘴温度、真空时间、注蜡时间精度更高;
- 2、控制箱预设的程序参数控制注蜡压力、注蜡时间、压模压力、进模压力等;

技术参数:

电源: 单相 AC 220V ±10% 50/60 HZ
功率: 500W
保险丝规格: 5A/250V
蜡缸加热温度范围: 0-95°C
蜡嘴加热温度范围: 0-95°C
真空定时范围: 0-20S
注蜡定时范围: 0-20S
蜡缸容量: 3kg
蜡缸设置压力: <200KPa
夹具升降方式: 手动调节

IW-5ME 控制箱 IW-5ME control box

技术参数:

压缩空气: 500KPa
调压阀设置压力: 400KPa
注蜡压力<200KPa
程序数量: 10

真空泵 Vacuum pump

技术参数:

电源: 单相 AC 220V±10%, 50/60Hz
功率: 120W
最大真空压力: 100KPA
抽气速率: 1.2L/S
加油量: 160ML

PRODUCT FEATURES:

1. Digital setting and display of the temperature of the wax chambers and nozzles, time of vacuum and wax injection, and higher precision.
2. You can control the pressure and time for wax injection, pressure for molding and putting rubber molds into the clamps.

TECHNICAL PARAMETERS:

Voltage: Single phase AC 220V±10%, 50/60 HZ
Power: 500W
Fuse specifications: 5A/250V
Heating temperature range of wax bath: 0-95°C
Wax nozzle heating temperature range: 0-95°C
Vacuum timing range: 0-20S
Wax injection timing range: 0-20S
Wax tank capacity: 3kg
Wax tank setting pressure: <200KPa
The movement of clamps: manually adjustable

TECHNICAL PARAMETERS:

Air compression: 500KPa
Pressure regulator setting range: 400KPa
Pressure for wax injection: <200KPa
Programs: 1000

TECHNICAL PARAMETERS:

Power supply: Single phase AC 220V±10%, 50/60Hz
Power: 120W
Maximum vacuum pressure: 100KPA
Pumping rate: 1.2 L/S
The amount of oil: 160ML



IW-5S 真空注蜡机
IW-5S Vacuum wax injector

技术参数:

电源: 单相 AC 220V±10%, 50/60Hz
功率: 500W
保险丝规格: 5A / 250V
蜡缸加热范围: 55-85°C (±0.1°C)
蜡嘴加热范围: 55-85°C (±0.1°C)
真空定时范围: 0-12S (±0.1s)
注蜡定时范围: 0-12S (±0.1s)
蜡缸容量: 3Kg
蜡缸设置压力: <200KPa

TECHNICAL PARAMETERS:

Voltage: Single phase AC 220V±10%, 50/60Hz
Power: 500W
Fuse specifications: 5A/250V
Heating temperature range of wax bath: 55-85°C(±1°C)
Wax nozzle heating temperature range: 55-85°C(±1°C)
Vacuum timing range: 0 - 12 S(±0.1s)
Wax injection timing range: 0 - 12S (±0.1s)
Wax tank capacity: 3kg
Wax tank setting pressure: <200KPa



真空泵
Vacuum pump

技术参数:

电源: 单相 AC 220V±10%, 50/60Hz
功率: 120W
最大真空压力: 100KPA
抽气速率: 1.2L/S
加油量: 160ML

TECHNICAL PARAMETERS:

Power supply: Single phase AC 220V±10%, 50/60Hz
Power: 120W
Maximum vacuum pressure: 100KPA
Pumping rate: 1.2 L/S
The amount of oil: 160ML

可升降机械手
Movable auto clamp

标准夹具胶模尺寸
Standard size for rubber mould
型号 Model: Z.M.WI.PIW009-B
L135×W105×D45(mm)

加宽型大夹具胶模尺寸
Extra size for rubber mould
型号 Model: Z.M.WI.PIW009
L135×W135×D60(mm)

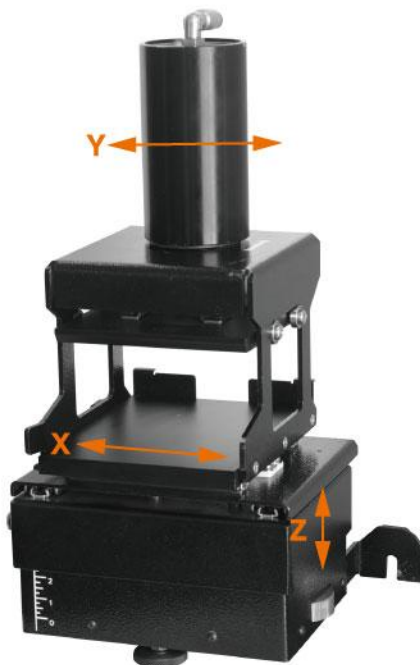

Z 极限高度控制

由于自动高度控制, 喷嘴完美地满足橡胶模具, 位置可以存储为参数。

Z Ultimate height control

Thanks to automatic height control, Nozzle perfectly meets the rubbermold. Position can be stored as aparameter.

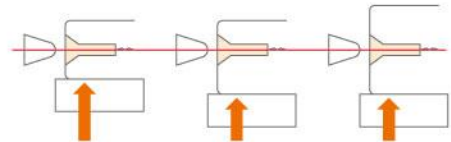

Y 可调夹紧点

橡胶模具中的主模型不在中心, 适当的压力位置可确保注射无泄漏。

Y Adjustable clamp pressure point

Master model in the rubber mold is not always placed in the center. Appropriate pressure position ensures the injection to be done without leakage.

● 指向 Point

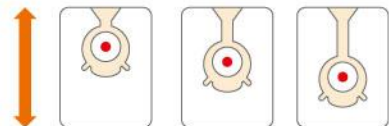

X 极限滑轨

最平滑的滑动使橡胶模具能够轻松找到喷嘴的中心, 以避免错位。

X Ultimate smooth slide

Ultimately smooth slide enables rubber molds to find the center of the nozzle easily to avoid mispositioning.

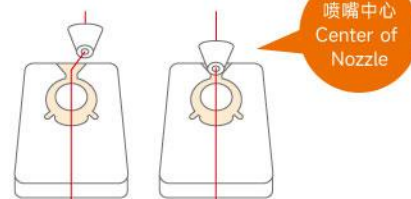



小型智能立体蜡镶机器人 Small Intelligent Stereoscopic Wax Model Inlaid Stone Robot

产品特点 PRODUCT FEATURES:

- 支持多种大小型号钻石加工。
Support to process various kinds of stones.
- 支持文件拷贝多机共享，快速批量化生产。
Files can be copied and shared on multiple machines, to achieve to achieve fast batch production.
- 点钻速度6000-8000粒/小时。
Speed up to 6000-8000 grains/hour.
- 一台设备可替代4-8个人，为整个饰品行业的生产加工节省大量的人力资源。
One piece of Device can replace 4-8 people, saving a lot of human resources for the production and processing of the entire jewelry industry.
- 钻石加热功能，提高合格率，降低掉石率。
Stone heating function, improves the pass rate and reduces the dropping stones rate.
- 石位示教快速 智能键盘多轴同时移动。
Quick stone pit teaching - intelligent keypad, simultaneous axis movement.
- 自主开发系统 保证产品软件无限升级。
Self-developed system - guaranteeing permanent system upgrade.
- 多种颜色石头可同时加工。
Multi - colour stones to be processed simultaneously.
- 五轴柔性联动 立体/曲面/平面等蜡镶工艺皆可加工。
Five-axis flexible linkage - accessing to stereoscopic/cambered/planar wax model process.

应用行业:

用于珠宝首饰加工蜡镶工艺，金、银、铜等需要精准蜡模镶石、镶钻的优秀选择。

APPLICATION INDUSTRY:

For wax model inlaid stones process in jewelry process industries, it is a better choice for gold, silver, copper products processing which need be inlaid stones.

技术参数 TECHNICAL PARAMETERS:

型号 Model	M.MS.SN002
点钻速度 Inlaid Stone Speed	10000-1200CPH
点钻精度 Inlaid Stone Accuracy	±0.02mm
工作电源 Working Power	AC220V/50Hz
额定功率 Power Rating	3.2KW
传动方式 Transmission Mode	精密嵌入式模组 Precision -insert Module
驱动系统 Drive System	高精伺服驱动系统+步进电机 High Precision Servo Drive System+Stepping Motor
操作方式 Operation Method	触摸屏+手持数字键盘 Touch screen / Handheld numeric keypad
床身结构 Machine Tool Structure	悬臂结构 Cantilever Structure
主操作系统 Main Operation System	64位Windows系统 64 Bits Windows
吸钻头数量 Number of Nozzles	3 吸嘴 (可定制) 3 Nozzles (customizable)
控制系统 Control System	总线控制系统 Bus Mastering
有效行程 Effective Travel	X:300mm, Y:300mm, Z:100mm
工作气压 Working Air Pressure	80psi
设备尺寸 Machine Size	750x700x1400mm
整机重量 Machine Weight	330KG

双工位小型智能立体蜡镶机器人 Dual-Station Small Intelligent Stereoscopic Wax Model Inlaid Stone Robot

产品特点 PRODUCT FEATURES:

- 满足珠宝首饰、金、银、铜等蜡模3D弧面蜡镶工艺。
Can meet the inlaid processing of wax molds of jewelry, gold, silver and copper on a 3D curved wax inlay process.
- 具有快速做模的优势，随机配送特制做模胶泥，可快速做模；胶泥持久耐用，不变形。
Have a strength of making molds quickly. silicon putty which can be quickly molded; the cement is durable and not easy to be deformed.
- 支持多种大小型号钻石加工。
Achieve fast batch production.
- 双工位，同时加工可替代4-8人，实际加工效率13000-15000粒/小时。
two operating position Device can replace 4-8 people, Speed up to 13000-15000cph.
- 钻石加热功能，提高合格率，降低掉石率。
Stone heating function, improves the pass rate and reduces the dropping stones rate.
- 五轴柔性联动 立体/曲面/平面等蜡镶工艺皆可加工。
Five-axis flexible linkage-accessing to stereoscopic/cambered/planar wax model process.
- 自主开发控制系统 保证产品软件无限升级。
Self-developed control system-guaranteeing permanent system upgrade.
- 双工位加工，实现无间断上料，循环加工，大大提升了效率和产能。
Processing on double stations, continuous loading, circle machining, achieve higher efficiency.
- 高智能漏钻检测功能，自动辨识，不存在漏钻、空钻不加工。
With high intelligent missing stone detection function, automatically identified, no missing stone, no empty setting during process.

应用行业:

用于珠宝首饰加工蜡镶工艺，金、银、铜等需要精准蜡模镶石、镶钻的优秀选择。

APPLICATION INDUSTRY:

For wax model inlaid stones process in jewelry process industries, it is a better choice for gold, silver, copper products processing which need be inlaid stones.



技术参数 Technical parameters:

型号 Model	M.MS.SN003
点钻速度 Inlaid Stone Speed	13000-1500CPH
点钻精度 Inlaid Stone Accuracy	±0.02mm
工作电源 Working Power	AC220V/50Hz
额定功率 Power Rating	3.2KW
传动方式 Transmission Mode	精密嵌入式模组 Precision -insert Module
驱动系统 Drive System	高精伺服驱动系统+步进电机 High Precision Servo Drive System+Stepping Motor
操作方式 Operation Method	触摸屏+手持数字键盘 Touch screen / Handheld numeric keypad
床身结构 Machine Tool Structure	悬臂结构 Cantilever Structure
主操作系统 Main Operation System	64位Windows系统 64 Bits Windows
吸钻头数量 Number of Nozzles	3 吸嘴 (可定制) 3 Nozzles (customizable)
控制系统 Control System	总线控制系统 Bus Mastering
有效行程 Effective Travel	X:300mm, Y:300mm, Z:100mm
工作气压 Working Air Pressure	80psi
设备尺寸 Machine Size	750x700x1400mm
整机重量 Machine Weight	330KG

金属模注蜡机 Metal mould wax injector

产品特点:

金属模注蜡机在处理难度高的出蜡、锐角、高精度装配件等方面有胶模注蜡机难以比拟的优势。

PRODUCT FEATURES:

It has big advantages over rubber mould wax injector when make complicated, sharp corner and high precision wax parts.



M.WI.A0001, M.WI.A0005



M.WI.A0008, M.WI.A0002-J, M.WI.A0002-180

可定制更大规格金属模注蜡机
Larger specification metal film wax injection machine can be customized

技术参数 TECHNICAL PARAMETERS:

型号 Model	M.WI.A0001	M.WI.A0005	M.WI.A0008	M.WI.A0002-J	M.WI.A0002-180
电压 Voltage	220V	220V	220V	220V	220V
功率 Power	500W	500W	1.5Kw	1.8Kw	2.0Kw
尺寸 Size	500×370×830mm	500×400×1060mm	580×420×1200mm	720×450×1240mm	900×500×1460mm
重量 Weight	31KG	58KG	100KG	150KG	200KG
最大模具尺寸 Maximum Mould Size	70×60mm	70×120mm	高 Height 250mm	高 Height 300mm	高 Height 500mm

1L注蜡机真空泵 1 L vacuum pump for wax injector

产品特点:

1. 专业订制电磁阀。
2. 专业消声改装。
3. 防止真空油外溢。
4. 抽真空更彻底。

技术参数:

型号: M.VP.G001L
电源: 220V, 50/60Hz, 单相

PRODUCT FEATURES:

1. Customized solenoid valve.
2. Sound proof modification.
3. Avoid vacuum oil overflow.
4. Maximally vacuum.

TECHNICAL PARAMETERS:

Model: M.VP.G001L
Power supply: 220V, 50/60Hz, 1 phase



真空泵 Vacuum pump

型号 Model	M.CM.00004-1	M.CM.P0008-03
空气排量 Free air Displacement	10CFM	10CFM
最大真空值 Ultimate Vacuum	3×10^{-1} Pa	5Pa
电压 Voltage	220V/50HZ	220V/50HZ
功率 Power	1HP	1HP
真空油量 Oil Capacity	500ml	450ml



型号 Model : Z.M.CM.00004-1

水冷真空泵 Water cooling vacuum pump

型号 Model	M.VP.0015A	M.VP.0030A	M.VP.0070A	M.VP.0100A
电压 Voltage	220V / 380V	380V	380V	380V
抽气速率 Air exhaust	15 L/s	30 L/s	70 L/s	98.5 L/s
电机功率 Motor power	1.5Kw	3Kw	5.5Kw	7.5Kw
电机转速 Motor speed	1400 r/min	1420 r/min	1440 r/min	1440 r/min
进气口直径 Air inlet diameter	60 mm	70 mm	90 mm	100 mm
尺寸 Size	66×44×58cm	73×47×67cm	85×60×61cm	110×74×91cm
重量 Weight	123kg	231kg	395kg	450kg



型号 Model : M.VP.0015A

蜡
Wax injection

德国普旭风冷真空泵 German BUSCH air cooling vacuum pump

型号 Model	M.VP.R0020	M.VP.R0040	M.VP.R0063	M.VP.R0100
电压 Voltage	380V 50Hz/60Hz	380V 50Hz/60Hz	380V 50Hz/60Hz	380V 50Hz/60Hz
额定抽速 Rated speed (m ³ /h)	20 / 24	40 / 48	63 / 76	100 / 120
极限压力 Max pressure hPa (mbar)	2.0	2.0	0.1	0.1
电机额定功率 Motor rated power (kW)	0.75 / 0.75	1.5 / 1.5	2.0 / 2.4	2.7 / 3.4
电机额定转速 Motor rated speed (min ⁻¹)	3000 / 3600	3000 / 3600	1500 / 1800	1500 / 1800
噪声级 (ISO 2151) dB (A) Noise level (ISO 2151)	70	75	64 / 67	65 / 68
注油量 Gas amount (L)	0.45	0.8	2.0	2.0
进气口/排气口 Inlet / Exhaust (G)	- / 3/4"	1 1/4" / 1 1/4"	1 1/4" / 1 1/4"	1 1/4" / 1 1/4"
尺寸 Size (mm)	323x231x211	432x256x238	627x406x290	701x406x290
重量 Weight (kg)	19	29	55	73



型号 Model : M.VP.R0040

空压机 Air compressor



型号 Model : M.A.C.A0050

型号 Model	M.AC.A0030	M.AC.A0050	M.AC.A0100
功率 Power (W)	750	1500	3300
气缸 Cylinder (mm)	69.7x13x2	69.7x13x4	63.7x20x6
转速 Speed (r.p.m.)	1380	1380	1380
压力 Pressrue (Bar)	7.0	7.0	7.0
排气量 Capacity (L/min)	60	120	300
储气罐 Tank (L)	30	50	100
净重 N.W. (KG)	19	33.5	90
外形尺寸 Outside size (mm)	555x255x510	685x300x530	1200x480x870

注蜡操作流程 Wax injection process



1、打开注蜡机顶盖，倒入适量艺辉牌铸造蜡珠。
1. Open the Lid of wax injector, Pour into adequate Yihui Brand wax beads .



2、打开电源，调节好主机及机械手控制器相关性控制参数并打开机械手自动感应操作开关。
2. Open the power switch, adjust the related control parameter of wax injector and auto-clamp, then open the automatic operation sensor for auto-clamp .

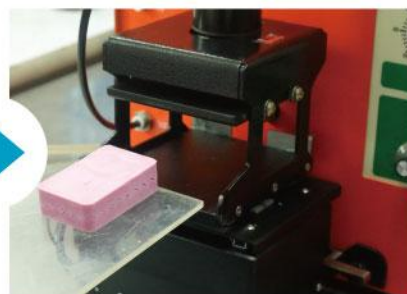

3、待蜡珠熔化后将胶模放在带芯片自动感应记忆亚克力板的中间再一起放到机械手夹具中。
3. Put the rubber mould in the middle of the acrylate board, which has the function of autoinductive memory, then put them together in the clamp .

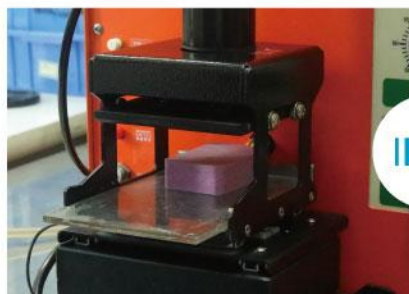

4、机械手自动感应夹住胶模推送至注蜡嘴注蜡，注蜡完成后自动退回原位。
4. The auto-clamp will auto-induct the rubber mould and push the rubber mould to the wax pot Nozzle, then return back after finishing of wax injection.



5、取出胶模并打开，得到完美蜡件。
5. Take out the rubber mould and open it, get the perfect wax model.



6、修整蜡件，用电烙铁焊接成蜡树。
6. Trim the wax model, Welding each wax model onto the wax pole.

电烙铁 Soldering iron

名称 Description	型号 Model
电烙铁调速器/调温电烙铁 Electric iron speeder / Thermostat electric iron	T.EI.PJ001
30W焊蜡器长寿电烙铁 30W soldering iron for wax welder	T.EI.C0030
40W焊蜡器长寿电烙铁 40W soldering iron for wax welder	T.EI.C0040
60W焊蜡器长寿电烙铁 60W soldering iron for wax welder	T.EI.C0060
35W电烙铁 35W electric iron	T.EI.A0007
20W 电烙铁 20W electric iron	T.EI.A0008



电烙铁调速器/调温电烙铁
Electric iron governor / thermostat electric iron
T.EI.PJ001



30W焊蜡器长寿电烙铁
30W soldering iron for wax welder
T.EI.C0030



40W焊蜡器长寿电烙铁
40W soldering iron for wax welder
T.EI.C0040



焊蜡器 Wax welder

产品特点:

具有灵活的焊蜡笔，有脚动控制温度的开关；随时可以调节温度。

技术参数:

型号: M.WW.00001
温度: 60°~500°C
电源: 220V, 50/60Hz, 单相
功率: 50W

PRODUCT FEATURES:

With flexible wax pen, and pedal to control temp switch; you can adjust temp at any time.

TECHNICAL PARAMETERS:

Model: M.WW.00001
Temp: 60°~500°C
Power supply: 220V, 50/60Hz, 1 phase
Power input: 50W



焊蜡器 Wax welder

产品特点:

具有灵活的焊蜡笔，随时可以调节温度。

技术参数:

型号: M.WW.00002
温度: 60°~500°C
电源: 220V, 50/60Hz, 单相
功率: 50W

PRODUCT FEATURES:

With flexible wax pen, you can adjust temp at any time.

TECHNICAL PARAMETERS:

Model: M.WW.00002
Temp: 60°~500°C
Power supply: 220V, 50/60Hz, 1 phase
Power input: 50W



焊蜡器 Wax welder

产品特点:

具有灵活的焊蜡笔，随时可以调节温度。

技术参数:

型号: M.WW.00003
温度: 60°~500°C
电源: 220V, 50/60Hz, 单相
功率: 50W

PRODUCT FEATURES:

With flexible wax pen, you can adjust temp at any time.

TECHNICAL PARAMETERS:

Model: M.WW.00003
Temp: 60°~500°C
Power supply: 220V, 50/60Hz, 1 phase
Power input: 50W

智能上树机
Sprue Holder

型号 Model	M.SH.00.01
产品尺寸 Product size	130×160×420(mm)
机身主材料 Body material	铝材 Aluminum
圆盘直径 Disc diameter	Φ130mm



Freeman wax (原装进口)
Made in U.S.A

系列蜡珠和蜡片，皆美国生产，品质卓越，适合各种工件。性能、颜色可以提供多种选择，是您生产加工的必选！
USA imported wax beads and wax flakes, good quality and suitable for various applications. color is optional.



大红色蜡片
Freeman Super Pink Flakes



粉红色蜡片
Freeman Filigree Pink Flakes



湖水绿色蜡片
Freeman Tuffy Green Flakes



草绿色蜡片
Freeman Aqua Green Flakes

型号 Model	Ruby red	Supper Pink	Tuf Guy Green	Aqua Blue	Aqua Green	Flexible Blue	Carvable Purple	Filigree Pink
Colour 颜色	Ruby red 枣红色			Aqua Blue 湖水蓝	Aqua Green 湖水绿色	Flexible Blue 彩蓝	Carvable Purple 紫色	Filigree Pink 粉红色
Al-Purpose/Versatility 多用途/多功能	✓			✓	✓			
Fine Detail & Filigree 细节和花丝								✓
Stone-in-Place Casting 镶石铸造			✓			✓		
Large Models 大型			✓					
Bezels/Clasps/Claws 斜面/扣/爪		✓					✓	
Carving/Rework 雕刻/返工								
Metal Molds 金属模具								

艺辉牌 通用蜡 Yihui Universal

产品特点:

油脂丰富、流动性强、易脱蜡、适合所有类型工件。

PRODUCT FEATURES:

Rich in grease, strong fluidity, easy to dewaxing, suitable for all types of workpieces.



艺辉牌 冬蜡 Yihui Inverno

产品特点:

无气泡、流动性高、缩水小、适合所有类型工件。低温使用效果更佳。

PRODUCT FEATURES:

No bubble, high fluidity, small shrinkage, suitable for all types of workpieces, Better effect at low temperature.



艺辉牌 花丝蜡 Yihui Filigree

产品特点:

流动性高、缩水小、适合所有类型工件，做花丝蜡件效果更佳。

PRODUCT FEATURES:

High fluidity, small shrinkage, suitable for all types of workpieces, The effect of making filigree wax is better.



艺辉牌 大件蜡 Yihui Massive

产品特点:

低收缩性、韧性好、耐用、铸造大件效果更佳。

PRODUCT FEATURES:

Low shrinkage, good toughness, durability, better effect of casting large parts.





艺辉牌蜡珠 Yihui brand wax beads

型号 Model: YH.W.205A/YH.W.215A/YH.W.605A

产品特点:

粉红色、中性、流动性高、缩水小、适合所有类型工件。

PRODUCT FEATURES:

Pink, Neutral, Higt flowability, Small shrinkage, Suitable for all kinds of casting.

型号 Model: YH.W.206A/YH.W.216A/YH.W.606A

产品特点:

翠绿色、中性、油脂丰富、流动性高、易脱蜡、适合所有类型工件。

PRODUCT FEATURES:

Jade green, Neutral, Rich in oil, Higt flowability, Easy for dewaxing, Suitable for all kinds of casting.

型号 Model: YH.W.208A/YH.W.218A/YH.W.608A

产品特点:

湖水绿、中性、流动性高、缩水小、适合所有类型工件。

PRODUCT FEATURES:

Aqua green, Neutral, Higt flowability, Small shrinkage, Suitable for all kinds of casting.

型号 Model: YH.W.209A/YH.W.219A/YH.W.609A

产品特点:

浅蓝色、韧性好、适合铸造大件。

PRODUCT FEATURES:

Light blue, good flexibility, Suitable for big casting.

型号 Model: YH-W806

产品特点:

绿色、中性、流动性高、缩水小、适合所有类型工件。

使用温度: 65°C~75°C

PRODUCT FEATURES:

Green, Neutral, Higt flowability, Small shrinkage, Suitable for all kinds of casting.

Working temp: 65°C~75°C

型号 Model: YH-W807

产品特点:

湖水绿、中性、流动性高、缩水小、适合所有类型工件。

使用温度: 65°C~75°C

PRODUCT FEATURES:

Aqua green, Neutral, Higt flowability, Small shrinkage, Suitable for all kinds of casting.

Working temp: 65°C~75°C

型号 Model: YH-W901

产品特点:

绿色、中性、流动性高、缩水小、适合所有类型工件。

使用温度: 65°C~75°C

PRODUCT FEATURES:

Green, neutral, Higt flowability, Small shrinkage, Suitable for all kinds of casting.

Working temp: 65°C~75°C





205 / 505A



509



206 / 506B



901 / 807 / 508



216



209D / 219D

蜡片
Wax Injection

艺辉牌蜡珠性能参数
Yihui brand wax beads property parameter

型号 Model	熔化温度 Melting point	注蜡温度 Injection temp.	燃点温度 Flash point	比重 Specific gravity	体积收缩率 Volume shrinkage	颜色 Colour	粘性 Viscosity (70°C)
YH.W.205A	65°C-72°C	70°C-75°C	240°C	<1(0.8-0.9)(H2O=1)	1%	粉红色 Pink	295
YH.W.206A	65°C-72°C	70°C-75°C	240°C	<1(0.8-0.9)(H2O=1)	1%	翠绿色 Jade green	295
YH.W.206S	65°C-72°C	70°C-75°C	240°C	<1(0.8-0.9)(H2O=1)	1%	湖水绿 Aqua green	295
YH.W.208A	65°C-72°C	70°C-75°C	240°C	<1(0.8-0.9)(H2O=1)	1%	湖水绿 Aqua green	295
YH.W.209A	65°C-72°C	70°C-75°C	240°C	<1(0.8-0.9)(H2O=1)	1%	浅蓝色 Light blue	295
YH.W.209S	65°C-72°C	70°C-75°C	240°C	<1(0.8-0.9)(H2O=1)	1%	蓝色 Blue	295
YH.W.215A	65°C-75°C	68°C-75°C	240°C	<1(0.8-0.9)(H2O=1)	1-1.5%	粉红色 Pink	310
YH.W.216A	65°C-75°C	68°C-75°C	240°C	<1(0.8-0.9)(H2O=1)	1-1.5%	翠绿色 Jade green	310
YH.W.218A	65°C-75°C	68°C-75°C	240°C	<1(0.8-0.9)(H2O=1)	1-1.5%	湖水绿 Aqua green	310
YH.W.219A	65°C-75°C	68°C-75°C	240°C	<1(0.8-0.9)(H2O=1)	1-1.5%	浅蓝色 Light blue	310
YH.W.605A	65°C-72°C	70°C-75°C	240°C	<1(0.8-0.9)(H2O=1)	0.5-1%	粉红色 Pink	285
YH.W.606A	65°C-72°C	70°C-75°C	240°C	<1(0.8-0.9)(H2O=1)	0.5-1%	翠绿色 Jade green	285
YH.W.608A	65°C-72°C	70°C-75°C	240°C	<1(0.8-0.9)(H2O=1)	0.5-1%	湖水绿 Aqua green	285
YH.W.609A	65°C-72°C	70°C-75°C	240°C	<1(0.8-0.9)(H2O=1)	0.5-1%	浅蓝色 Light blue	285
YH-W806	65°C-72°C	70°C-75°C	240°C	<1(0.8-0.9)(H2O=1)	0.5-1%	绿色 Green	285
YH-W807	65°C-72°C	70°C-75°C	240°C	<1(0.8-0.9)(H2O=1)	0.5-1%	湖水绿 Aqua green	285
YH-W807S	65°C-72°C	70°C-75°C	240°C	<1(0.8-0.9)(H2O=1)	0.5-1%	绿色 Green	285
YH-W901	65°C-72°C	70°C-75°C	240°C	<1(0.8-0.9)(H2O=1)	0.5-1%	绿色 Green	285
YH-W901S	65°C-72°C	70°C-75°C	240°C	<1(0.8-0.9)(H2O=1)	0.5-1%	绿色 Green	285
YH-W906	65°C-72°C	70°C-75°C	240°C	<1(0.8-0.9)(H2O=1)	0.5-1%	绿色 Green	285
301AA	68°C-72°C	71°C-74°C	240°C	<1(0.8-0.9)(H2O=1)	0.5-1%	翠绿色 Jade green	176-251

* 以上数据仅供参考 Only for reference of above data.

水溶蜡
Yihui brand wax



型号 Model: YH.BW.908-A

产品特点:

铁红色，缩收较小，不易缩水，适合大件，强度不及灰色，不含纤维，适合孔径较小产品。

PRODUCT FEATURES:

Iron red, with slightly low shrinkage rate and strength lower than that of the grey one, not easy to shrink, suitable for large workpiece with tiny holes, free of fibre.



型号 Model: YH.BW.908-B

产品特点:

粉红色，流动性较好，适合小件，含有微量纤维。

PRODUCT FEATURES:

Pink, good fluidity, suitable for small workpiece, containing a little of fibre.



型号 Model: YH.BW.908-C

产品特点:

白色，流动性较好，收缩稍微大些，溶化速度快，适合大件，含有微量纤维。

PRODUCT FEATURES:

White, good fluidity, with slightly high shrinkage rate, fast dissolving, suitable for big workpiece, containing a little of fibre.



型号 Model: YH.BW.909-D

产品特点:

灰白色，流动性较好，适合小件，含有微量纤维。

PRODUCT FEATURES:

Black, good fluidity, suitable for small workpiece, containing a little of fibre.



型号 Model: YH.BW.909-E

产品特点:

灰色，缩收较小，不易缩水，硬度较高，适合大件，含有微量纤维。

PRODUCT FEATURES:

Grey, with low shrinkage rate, not easy to shrink, strong hardness, suitable for big workpiece, containing a little of fibre.



型号 Model: YH.BW.909-F

产品特点:

朱红色，缩收较小，不易缩水，强度高，适合中大件，含有微量纤维。

PRODUCT FEATURES:

Vermilion, with slightly low shrinkage rate, not easy to shrink, high strength, suitable for medium and large workpiece, containing a little of fibre.



1盅不锈钢搅粉机 1Pcs flask vacuum mixer

产品特点:

本机主要功能为石膏粉搅拌及钢盅注粉。其体积小，一次最大放置4"×10"钢盅一个，更适应于工作室使用，其操作灵活，集搅拌、震动、抽真空等功能，便捷可靠。

PRODUCT FEATURES:

The main function of the machine is for mixing gypsum and injecting powder to flasks. The volume is small and it support max 1 pcs 4"×10" flasks at a time, and more suitable for studio. The operation is flexible, integrating functions such as stirring, vibration, and vacuuming which is convenient and reliable.

技术参数:

型号: M.VM.SAS01B
电源: 220V
功率: 60W
气压: 0.5MPa
抽气速度: 4L/S
搅拌速度: 145rpm
外形尺寸: 260×331×583mm
重量: 17kg

TECHNICAL PARAMETERS:

Model: M.VM.SAS01B
Power supply: 220V
Power input: 60W
Air pressure: 0.5MPa
Pumping rate: 4L/S
Mixing speed: 145rpm
Size: 260x331x583mm
Weight: 17kg



3盅不锈钢自动真空搅粉机 3 Pcs flask vacuum mixer

产品特点:

此机型最大容量一次可放4"×10"钢盅3个，操作一气呵成，快捷可靠。其性能优越之处在于能够在搅粉时间开始抽真空，使搅拌、注粉、做型整个过程在真空状态一次完成，与一般石膏粉抽真空机比较，省去了搅粉、抽真空、倒粉抽真空等复杂化的操作，还能够减少水珠（金珠、气泡）出现，使产品的光洁度做得更加完美，是高要求精密铸造的必须设备。

PRODUCT FEATURES:

One time can make investment capacity of 3 pcs of 4"×10" flasks, fast and convenient operation. The most advantage of this machine is that vacuum start while investment mixing, to have investment mixing and investment injection both working under vacuum condition, save your time, and reduce bubble to make a smooth surface item. It is a necessary equipment for high accuracy casting.

技术参数:

型号: M.VM.SAS03
电源: 三相 220V/380V 50/60HZ
单相 220V 50/60HZ
功率: 2KW
抽气速度: 15L/s
极限压力: 6×10^{-2} pa
重量: 85.5KG
外形尺寸: 890×580×1330mm

TECHNICAL PARAMETERS:

Model: M.VM.SAS03
Power supply: 3 phase 220V/380V, 50/60HZ
2 phase 220V, 50/60HZ
Power input: 2KW
Exhaust speed: 15L/s
Max pressure: 6×10^{-2} pa
Weight: 85.5KG
Size: 890×580×1330mm

5盅不锈钢自动真空搅粉机 5 Pcs flask vacuum mixer

产品特点:

此机型最大容量一次可放4"×10"钢盅5个，操作一气呵成，快捷可靠。其性能优越之处在于能够在搅粉时间开始抽真空，使搅拌、注粉、成型整个过程在真空状态一次完成，与一般石膏粉抽真空机比较，省去了搅粉、抽真空、倒粉抽真空等复杂化的操作，还能够减少水珠（金珠、气泡）出现，使产品的光洁度做得更加完美，是高要求精密铸造的必须设备。

使用说明:

- 1、设定搅粉时间（约3-4分钟）抽真空时间（约7-8分钟）；
- 2、将钢盅放进钢盅盘；
- 3、先把适量水放进搅粉桶，再加入石膏粉开动抽真空及搅粉开关；
- 4、当搅粉到达设定时间够蜂鸣器响，把石膏粉放到钢盅，直到抽真空时间完成蜂鸣器响，可把铸满石膏粉的钢盅拿出来完成。

选配功能:

- 1、可调速搅拌
- 2、下桶振动功能

技术参数:

型号: M.VM.SAS05
电源: 220/380V, 50/60HZ, 3相; 220V/50HZ
功率: 2KW
抽气速度: 15L/S, 30L/S
极限压力: 6×10^{-2} pa
下桶尺寸: $\Phi 370 \times 360$ mm
搅粉重量: 15KG
外形尺寸: 650×780×1400mm
重量: 134kg

PRODUCT FEATURES:

One time can make investment capacity of 5 pcs of 4"×10" flasks, fast and convenient operation. The most advantage of this machine is that vacuum start while investment mixing, to have investment mixing and investment injection both working under vacuum condition, save your time, and reduce bubble to make a smooth surface item. It is a necessary equipment for high accuracy casting.

OPERATION INSTRUCTION:

1. Set mixing time (about 3-4 mins) and vacuum time (7-8 mins)
2. Put flasks into down chamber
3. Pour suitable water into mixing chamber, then add investment, after that start mixing and vacuum.
4. When mixing finished, buzzer alarms, then start pouring mixed investment into flasks, vacuum again, buzzer alarms again when vacuum finished. Finally take out the flasks which is full with investment.

FUNCTION FOR OPTION

1. Adjustable speed for mixing
2. Vibration for underside barrel

TECHNICAL PARAMETERS:

Model: M.VM.SAS05
Power supply: 220V/380V, 50/60Hz, 3 phase; 220V/50HZ
Power input: 2KW
Exhaust speed: 15L/S, 30L/S
Max pressure: 6×10^{-2} pa
Down chamber size: $\Phi 370 \times 360$ mm
Mixing weight: 15KG
Size: 650×780×1400mm
Weight: 134kg



1.5mm厚不锈钢一体式机箱及防水操作按键

1.5mm thickness stainless steel made integrated cabinet and waterproof buttons



进口透明加厚亚克力板和全硅胶密封圈加大下桶

Imported transparent acrylic plate and thick silica gel sealing ring to increase barrel



自动搅粉装置

Automatic mixer installation



大力度马达, 选配调速或震动功能

large power motor, optional speed adjustment or vibration function





6盅不锈钢自动真空搅粉机 6 Pcs flask vacuum mixer

产品特点:

此机型最大容量一次可放5"×10"钢盅6个，操作一气呵成，快捷可靠。其性能优越之处在于能够在搅粉时间开始抽真空，使搅拌、注粉、成型整个过程在真空状态一次完成，与一般石膏粉抽真空机比较，省去了搅粉、抽真空、倒粉抽真空等复杂化的操作，还能够减少水珠（金珠、气泡）出现，使产品的光洁度做得更加完美，是高要求精密铸造的必须设备。

PRODUCT FEATURES:

One time can make investment capacity of 6 pcs of 5"×10" flasks, fast and convenient operation. The most advantage of this machine is that vacuum start while investment mixing, to have investment mixing and investment injection both working under vacuum condition, save your time, and reduce bubble to make a smooth surface item. It is a necessary equipment for high accuracy casting.

技术参数:

型号: M.VM.SAS06
电源: 380V, 50/60Hz, 三相
功率: 2kW
气压: 0.5Mpa
抽气速率: 63m³/h
真空泵注油量: 2L
真空度: 99.5KPa
搅拌速度: 0~300rpm
重量: 230kg
外形尺寸: 1590×750×1623mm
石膏粉容量: 20L
内置真空泵

TECHNICAL PARAMETERS:

Model: M.VM.SAS06
Power supply: 380V, 50/60Hz, 3 phase
Power: 2kW
Air pressure: 0.5MPa
Speed of evacuation: 63m³/h
Max vacuum pump oil: 2L
Vacuum: 99.5KPa
Mixing speed: 0~300rpm
Weight: 230kg
Size: 1590×750×1623mm
Max volume for powder: 20L
Built in vacuum pump

大钢盅不锈钢搅粉机 Big flask vacuum mixer

产品特点:

适用于佛像、香炉以及大件工艺品等制作石膏模具。其性能优越之处在于能够在搅粉时间开始抽真空，使搅拌、注粉、成型整个过程在真空状态一次完成，与一般石膏粉抽真空机比较，省去了搅粉、抽真空、倒粉抽真空等复杂化的操作，还能够减少水珠（金珠、气泡）出现，使产品的光洁度做得更加完美，是高要求精密铸造的必须设备。

PRODUCT FEATURES:

Its superior performance lies in its ability to initiate vacuum during the mixing process, enabling the entire procedure—mixing, powder injection, and molding—to be completed in a single vacuum cycle. Compared to conventional gypsum powder vacuum machines, it eliminates complex steps such as mixing, vacuuming, and powder transfer under vacuum. Additionally, it minimizes the formation of water droplets (metal beads or air bubbles), resulting in a more flawless surface finish. This makes it an essential piece of equipment for high-precision casting applications requiring stringent standards.

技术参数:

型号: M.VM.SAS10
电源: 380V, 50/60Hz, 三相
功率: 9KW
抽气速度: 70L/s
极限压力: 70Inhg
下桶尺寸: Φ600×650mm
搅粉重量: 30KG
外形尺寸: 860×930×1775mm
重量: 294kg

TECHNICAL PARAMETERS:

Model: M.VM.SAS10
Power supply: 380V, 50/60Hz, 3 phase
Power: 9KW
Exhaust speed: 70L/s
Max pressure: 70Inhg
Down chamber size: Φ600×650mm
Mixing weight: 30KG
Size: 860×930×1775mm
Weight: 294kg



可定制更大尺寸搅粉机

LARGER SIZE MIXER CAN BE CUSTOMIZED



石膏清洗机 Gypsum cleaning machine

产品特点:

配有高压水枪，脚踏控制，能快速清除铸件上残留的石膏粉。

技术参数:

型号: M.IC.00002-B / M.IC.00002

尺寸: 650×450×1500mm

重量: 54kg

PRODUCT FEATURES:

Equipped with water cannons, pedal control, can quickly remove the plaster casting residue.

TECHNICAL PARAMETERS:

Model: M.IC.00002-B / M.IC.00002

Size: 650×450×1500mm

Weight: 54kg

自动石膏清洗机 Automatic gypsum cleaning machine

产品特点:

内置切割喷嘴和多个高压清洗喷嘴，自动分割钢盅内部石膏及表面石膏清洗，能快速有效清除铸件上残留的石膏粉。具有加工范围广，清洗更干净、节能，操作简单等。

PRODUCT FEATURES:

The built-in cutting nozzle and multiple high-pressure cleaning nozzles can automatically divide the internal gypsum and surface gypsum cleaning of the flask, they can quickly and effectively remove the residual gypsum powder on the casting tree. It has the advantages of wide processing range, cleaner cleaning, energy saving and simple operation.

技术参数 TECHNICAL PARAMETERS:

型号 Model	M.IC.00001-B-1
电压 Voltage	220V
功率 Power	2KW
理论流量 Theoretical flow	10L/min
额定水压 Rated water pressure	11MPa
钢盅清洗尺寸 Flask size	Φ3~Φ5"×H300mm
外形尺寸 Size	1020×640×1030mm
重量 Weight	70kg

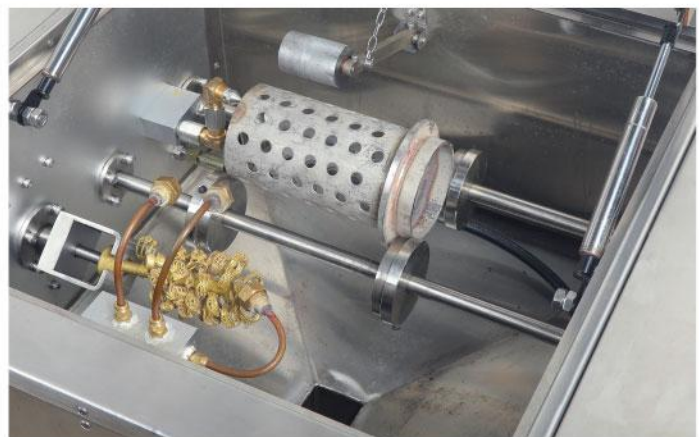

石膏粉 Investment powder

石膏粉系列产品是英国原装进口高质量产品，经过最高规格检验出厂。生产工厂系通过ISO9001认证工厂，拥有最先进的产品应用和开发实验设施，高素质的发展和专业技术人员。这更有利于我们对开发新。这更有利于我们对开发新产品、分析材料特性、评估产品应用过程 and 为客户铸造提供最佳解决方案！

系列产品适合不同产品的不同要求，完全满足对贵金属铸造表面光滑、铸件细腻、无缺陷的要求！同时每个型号我们都有50磅和100磅两种包装！我们也针对白金和钯金的生产，专门引进了日本的A-1 (min) 石膏粉，同时为了替客户节约生产成本，我们也研发了更加适合国内客户需求的艺辉牌铂金钯金石膏粉和艺辉牌不锈钢石膏粉。

UK imported high quality casting investment powder with strict quality standards control, factory passed ISO9001 equipped with advanced R&D testing facilities and professional engineers. All helps us to figure out the best solution during the process of new products design and audit.

Different series are available for various requirement to make a smooth, perfect surface casting items. We have 50 pounds and 100 pounds package. As the increased requirement or palladium and platinum casting, we imported Japan A-1 (min) casting investment powder. What's more, considering the cost factor we developed Yihui Brand casting investment powder for palladium and platinum casting, which is more welcomed in domestic market.

艺辉牌石膏粉开粉程序 Usage instruction of Yihui brand investment powder

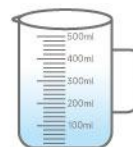

380-400ml



1000g

一、配粉比例

1. 量石膏粉1000克。
2. 量水380~400毫升（水温要求在22°C左右）。
3. 把水放入容器内，然后加入石膏粉。
4. 搅拌3.5-4分钟。
5. 倒入钢盅，然后再抽真空1.5-2分钟。
6. 平放静置60-120分钟。

I. MIXING RATE

1. Casting investment powder 1000g.
2. Water 380-400ml (Water temp about 22°C) .
3. Pour water into mixing chamber, then add casting investment powder.
4. Start mixing for 3.5-4mins.
5. Inject mixed investment powder into flasks, then start vacuum 1.5-2mins.
6. Take the flasks out, and wait 60-120mins before burning it

二、烧结

1. 室温到180°C需120分钟，从180°C到270°C需150分钟，保持270°C用150分钟。
2. 由270°C平均加热到730°C用150分钟。
3. 保持730°C用180分钟。
4. 然后回降到630°C左右，开始铸造。

II. BURN PROCESS

1. Put the flasks filled with investment powder into oven, turn up the temp to 270°C within 60mins, and keep at 270°C with 180 mins.
2. Rise temp evenly from 270°C to 730°C in 150 mins.
3. Keep at 730°C with 180mins.
4. Start casting when the temp run down to around 630°C.

开粉焙烧
Mix and burn



大件石膏粉 Bagged large gypsum powder



适用范围：适合金、银、铜铸造。

APPLICATION: suitable for gold, silver and copper casting.



型号 Model: P.33.C150
50磅/袋 50 lbs/bag



11 石膏粉 Investment powder



适用范围: 适合银、铜铸造。

APPLICATION: suitable for silver and copper casting.



型号 Model: P.11.B050
50磅/袋 50 lbs/bag



33 石膏粉 Investment powder



适用范围: 适合金、银、铜铸造。

APPLICATION: suitable for gold, silver and copper casting.



型号 Model: P.33.B050
50磅/袋 50 lbs/bag



型号 Model: P.33.D100
100磅/桶 100 lbs/drum



P.66.B050



P.66.D100

66石膏粉 Investment powder

适用范围: 适合铍、铜、K金铸造。

APPLICATION: suitable for beryllium, copper, K gold casting.

型号 Model: P.66.B050
50磅/袋 50 lbs/bag

型号 Model: P.66.D100
100磅/桶 100 lbs/drum



P.99.B050



P.99.D100

99石膏粉 Investment powder

适用范围: 适合铍、铜、K金铸造。

APPLICATION: suitable for beryllium, copper, K gold casting.

型号 Model: P.99.B050
50磅/袋 50 lbs/bag

型号 Model: P.99.D100
100磅/桶 100 lbs/drum



开粉焙烧
Mix and burn

金\银\铜烧结程序示意图 Gold\Silver\Brass powder burnout cycle

适用于艺辉牌大件石膏粉、11、33、66、99石膏粉
Apply to Yihui brand bagged large gypsum powder, 11, 33, 66, 99 investment casting powder

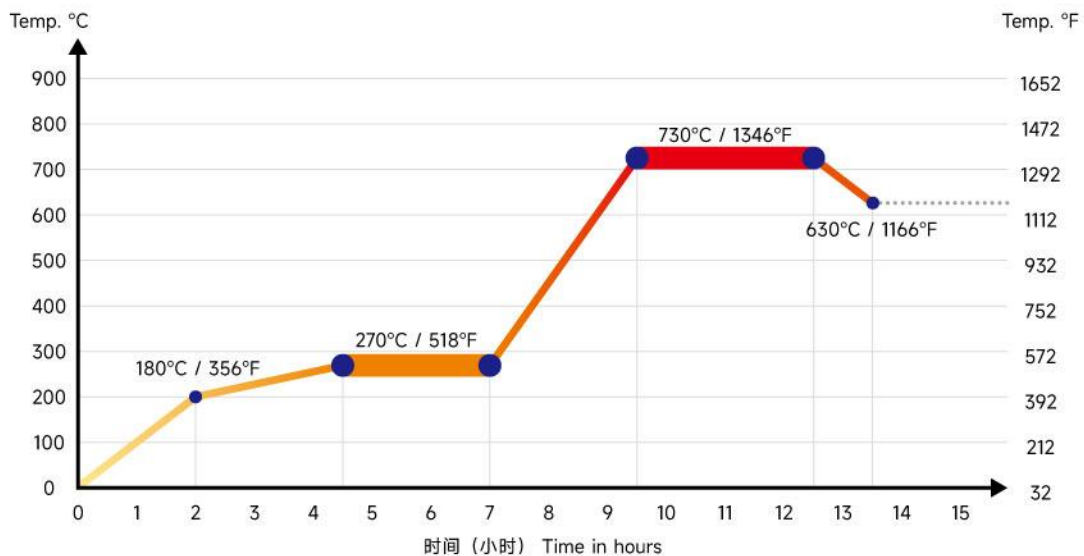



树脂石膏粉
Resin investment powder



适用范围：铸造树脂专用。
APPLICATION: suitable for resin casting.



型号 Model: P.RC.B050
50磅/袋 50 lbs/bag



型号 Model: P.RC.D100
100磅/桶 100 lbs/drum

混合与烧
Mix and burn

树脂石膏粉烧结程序示意图
Resin powder burnout cycle

适用于艺辉牌树脂石膏粉
Apply to Yihui brand resin investment powder.

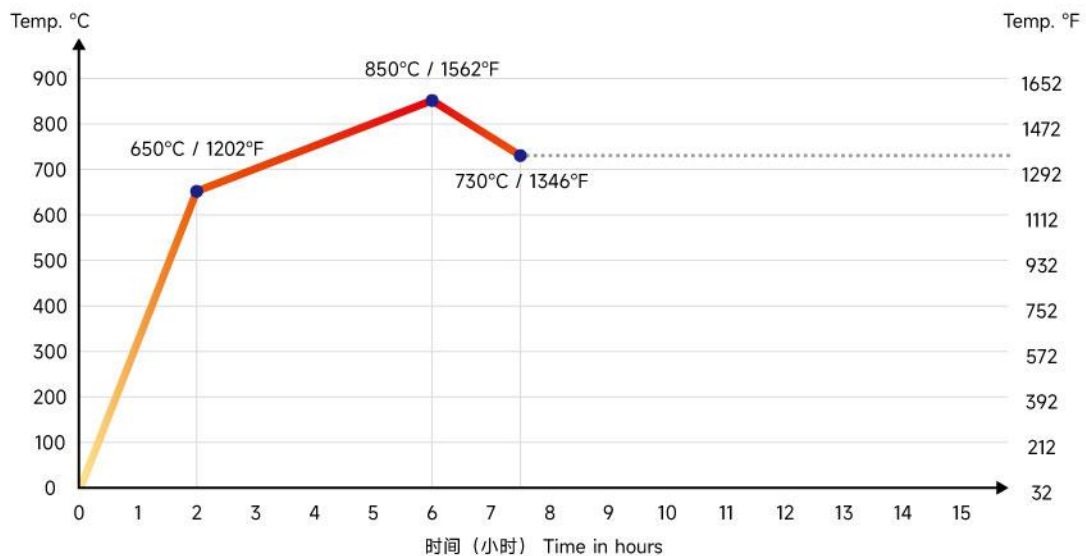



蜡镶石膏粉
Gemstone inlay investment powder

适用范围：适合蜡镶铸造。
APPLICATION: suitable for gemstones inlay casting.



型号 Model: P.SC.B050
50磅/袋 50 lbs/bag



型号 Model: P.SC.D100
100磅/桶 100 lbs/drum

开粉焙烧
Mix and burn

蜡镶石膏粉烧结程序示意图
Gemstone inlay investment powder burnout cycle

适用于艺辉牌蜡镶石膏粉
Apply to Yihui brand gemstone inlay investment powder.

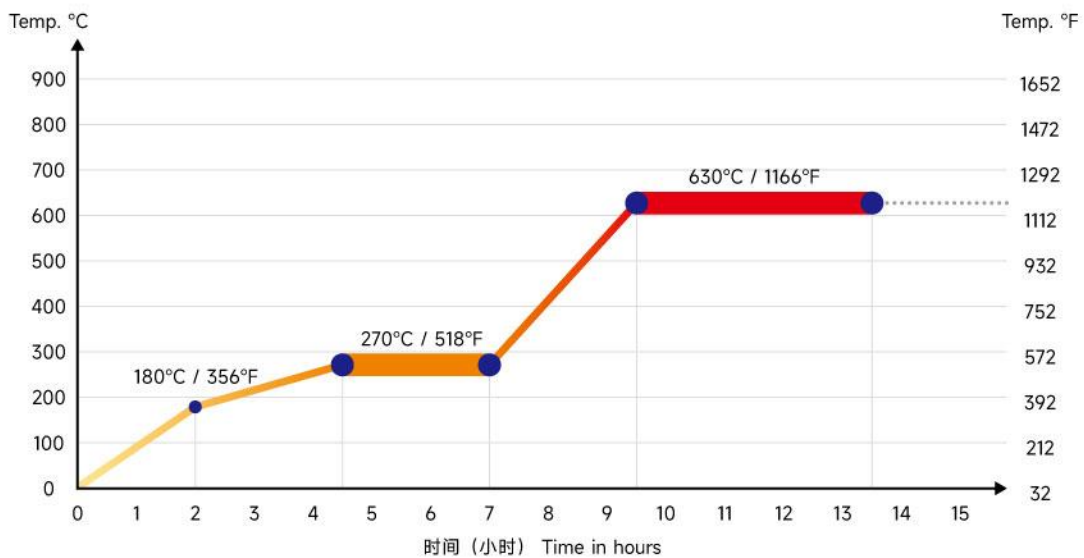

铂石膏粉 Investment powder for platinum

适用范围: 适合铂金铸造
APPLICATION: suitable for platinum casting.

型号 Model: S.900.C25
25kg/箱 25 kg/carton



不锈钢石膏粉 Investment powder for stainless steel

适用范围: 适合不锈钢铸造
APPLICATION: suitable for stainless steel casting.

型号 Model: P.316.C25
25kg/袋 25 kg/bag



艺辉牌不锈钢、钯金、铂石膏粉开粉程序

Usage instruction of Yihui brand investment powder for stainless steel, palladium and platinum

1、调配催干剂

催干剂与水的比例: 催干剂60毫升+水1000毫升, 搅拌均匀, 制成混合液, 用后请封好瓶盖。

2、调配不锈钢石膏

把不锈钢石膏粉加入到混合液中, 用电动搅拌机搅拌5-10分钟。粉和混合液的比例: 不锈钢石膏粉3333克+混合液1000毫升。

3、开粉

在这阶段, 钢盅必须放置在专用吸水纸上, 让水份平均地排去, 利用吸水纸, 也可确保防漏不锈钢石膏粉。

4、抽真空

抽空真空时间约8分钟左右。

5、不锈钢石膏粉烧结时间程序 (如下图示)

除蜡: 由室温到180°C需时间120分钟。

烧结: 由180°C到250°C需时间120分钟。

由250°C到400°C需时间60分钟。

由400°C到900°C平均每30分钟升温100°C, 即需时150分钟达到900°C, 维持900°C温度约60分钟。

注: 以上 (4)、(5) 两项操作为参考数据, 请按实际情况稍作调整。

1. Siccative mixing

Mixing rate: 60ml siccative+1000ml water to make mixed liquid, then cover on.

2. Stainless steel investment power mixing

Add investment power into the mixed liquid, electrically stir it with 5-10mins, mixing rate: 3333g stainless steel investment power+1000ml mixed liquid.

3. Investment casting process

Put the flask on the special absorbent paper.

4. Vacuum

Vacuum flask filled with mixed investment power around 8mins.

5. Burn steps, following process for reference only

Dewaxing: turn the oven to 180°C with 120mins.

Burning: rise temp from 180°C to 250°C with 120mins.

Turn up the temp from 250°C to 400°C with 60mins.

Increase temp from 400°C to 900°C evenly with 150mins, 100°C up per 30mins, when temp arrived 900°C keep 60mins.

REMARKS: The above step (4) and (5) are for reference only, please adjust the setting data based on particular use.

烧结程序示意图
Platinum powder burnout cycle

适用于艺辉牌钯金、铂金、不锈钢石膏粉
Apply to Yihui brand investment casting powder for palladium, platinum, stainless steel.

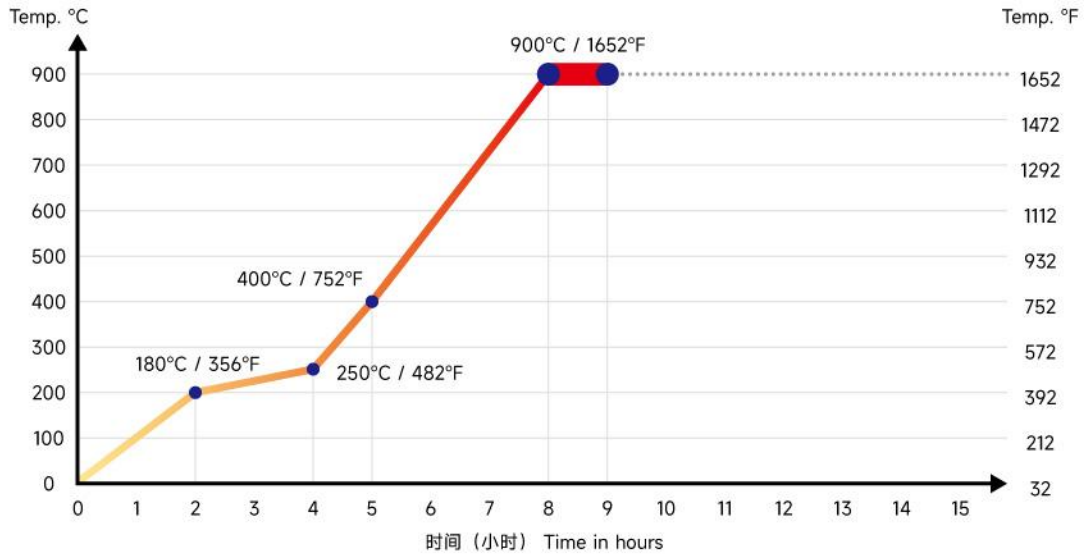

开粉焙烧
Mix and burn

铍铜烧结程序示意图
Brass powder burnout cycle

适用于艺辉牌铍铜石膏粉
Apply to Yihui brand brass powder.

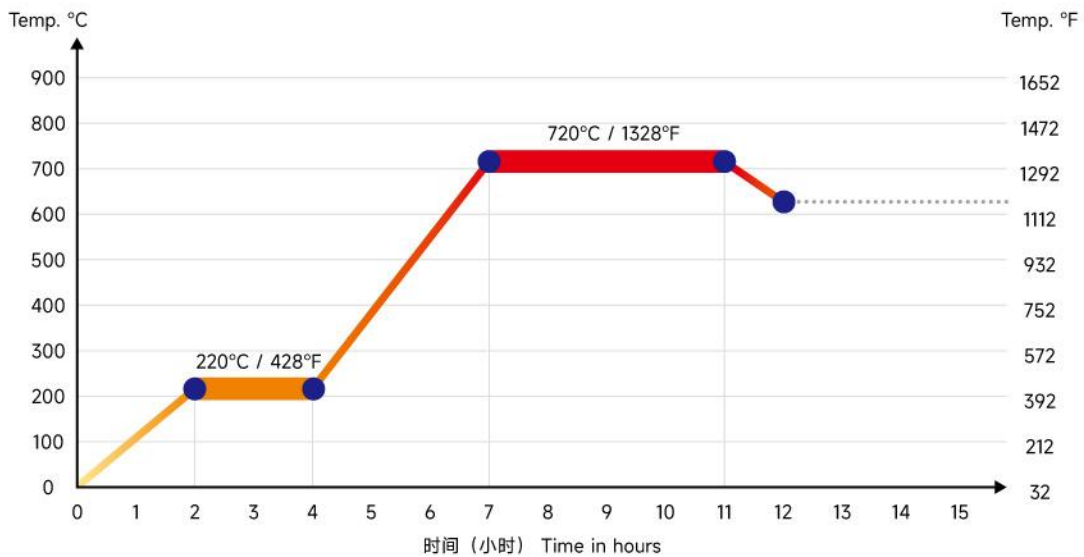

备注：以上数据仅供参考，请根据具体情况调整。
Remark: Above info is for reference only, it is subject to factory manual.

不锈钢电炉系列 Flask oven series

- 1、采用进口超高温耐磨保温砖，确保保温性能优。
- 2、设有断偶保护功能，当热电偶一旦烧坏或失效设备自动关闭，避免电炉失控而引起不必要的损失。
- 3、分段加热功能，可控制升温速度，以确保产品的烧结质量，能提高优质品率及能够延长发热丝的寿命。
- 4、独有的退蜡设计能提高优质品率及能够延长发热元件的使用。

1. Using imported high temperature resistant insulating brick, ensuring excellent heat insulating performance.
2. A break even protection function, when the thermocouple once burned or equipment failure automatic closed, avoid electric control and cause unnecessary losses.
3. Can control the heating rate, to ensure that the sintering quality products, can raise the rate of high quality and to prolong the life of the heating wire.
4. The unique wax removing design can improve the using rate of high quality and to prolong the heating element.



M.BO.SF-4



M.BO.S004



可定制加大电炉 OVENS WITH GREATER SPECIFICATIONS CAN BE CUSTOMIZED

技术参数 TECHNICAL PARAMETERS

名称 Description	型号 Model	功率 Power input	电压 Voltage	最高温度 Maximum temp	工作温度 Working temp	外形尺寸 Outline size LxWxH	炉膛尺寸 Internal size LxWxH	重量 Weight
4盞4"x8"不锈钢电炉 4PCS flask oven	M.BO.S004	3kW	220V	900°C	750°C-850°C	61×72×88cm	32×33×32cm	160 kg
4盞4"x8"电炉 4PCS flask oven	M.BO.SF-4	6kW	220V	900°C	750°C-850°C	65×70×77cm	32×33×32cm	\
24盞4"x8"电炉 24PCS flask oven	M.BO.SF-24	9kW	380V	900°C	750°C-850°C	94×100×165cm	47×60×59cm	\
40盞4"x8"电炉 40PCS flask oven	M.BO.SF-40	13.5kW	380V	900°C	750°C-850°C	106×110×165cm	60×69×59cm	\



M.BO.BB1006



M.BO.BB1032



M.BO.BB2024

开粉焙烧
Mix and burn

**可定制加大电炉
OVENS WITH GREATER SPECIFICATIONS CAN BE CUSTOMIZED**

技术参数 TECHNICAL PARAMETERS

名称 Description	型号 Model	功率 Power input	电压 Voltage	最高温度 Maximum temp	工作温度 Working temp	外形尺寸 Outline size LxWxH	炉膛尺寸 Internal size LxWxH	重量 Weight
4盅4"x10"双温控不锈钢电炉 4PCS flask oven (double control)	M.BO.BB1004	3kW	220V	1000°C	750°C-850°C	72x80x144cm	32x34x32cm	160 kg
6盅4"x10"双温控不锈钢电炉 6PCS flask oven (double control)	M.BO.BB1006	4kW	220V	1000°C	750°C-850°C	72x93x144cm	32x47.5x32cm	180 kg
12盅4"x10"双温控不锈钢电炉 12PCS flask oven (double control)	M.BO.BB1012	6kW	380V	1000°C	750°C-850°C	72x93x163cm	32x47.5x60cm	210 kg
18盅4"x10"双温控不锈钢电炉 18PCS flask oven (double control)	M.BO.BB1018	8kW	380V	1000°C	750°C-850°C	85x93x163cm	47.5x47.5x60cm	240 kg
24盅4"x10"双温控不锈钢电炉 24PCS flask oven (double control)	M.BO.BB1024-5	9kW	380V	1000°C	750°C-850°C	85x107x163cm	47.5x60x60cm	335 kg
32盅4"x10"双温控不锈钢电炉 32PCS flask oven (double control)	M.BO.BB1032	10.5kW	380V	1000°C	750°C-850°C	98x107x163cm	60x60x60cm	425 kg
40盅4"x10"双温控不锈钢电炉 40PCS flask oven (double control)	M.BO.BB4010	13.5kW	380V	1000°C	750°C-850°C	100x120x163cm	60x69x60cm	500 kg
24盅4"x9"双温控不锈钢环保电炉 24PCS flask oven (double control) air purification type	M.BO.BB2024	11kW	380V	1250°C	1000°C	85x107x205cm	47.5x60x60cm	345 kg

高温旋转电炉

High temperature rotary burnout oven

产品特点:

- 1、焙烧温度均匀，温度控制精度为 $\pm 5^{\circ}\text{C}$ ，温度显示范围0-950 $^{\circ}\text{C}$ 。
- 2、最高焙烧温度为900 $^{\circ}\text{C}$ ，温度显示精度为0.1 $^{\circ}\text{C}$ ，设有极限温度保护，当炉内温度超过设定温度时，发热丝电源自动切断，从而确保设备与产品不受损害。
- 3、环保效果良好，单独的二次焙烧，使炉内的废气进行二次燃烧，有效减少空气污染。
- 4、触屏控制，中英文切换，具有运行数据记录功能，最长能保存连续运行30天的数据，支持U盘导出CSV数据记录文件。
- 5、具有配方功能，最高支持保存30条配方，每条配方最多支持10阶段的斜坡温度。

PRODUCT FEATURES:

1. The burning temperature is uniform and control accuracy is $\pm 5^{\circ}\text{C}$ display range is 0-950 $^{\circ}\text{C}$.
2. Max burning temp is 900 $^{\circ}\text{C}$, Display accuracy is 0.1 $^{\circ}\text{C}$. With max temp protection, once temp is over setting temp, heating power is automatically cut off to ensure that machine and products are not damaged.
3. Good to environment, additional burning out the gas and reduce air pollution.
4. Touch screen, Chinese/English panel, with data record for 30 days and support CSV data output to U disk.
5. With 30 sets memory program, each program can include 10 phases of temperature setting.



9盅旋转电炉

9 PCS flasks rotary burnout oven

17盅旋转电炉

17 PCS flasks rotary burnout oven

40盅旋转电炉

40 PCS flasks rotary burnout oven

技术参数 TECHNICAL PARAMETERS

型号 Modelg	M.BO.RF09	M.BO.RF017	M.BO.RF030	M.BO.RF040	M.BO.RF050
电压 Voltage	400V AC 3faz +N 50/60Hz 220V AC 3faz 50/60Hz		400V AC 3faz +N 50/60Hz		
功率 Power input	$\leq 9\text{KW}$	$\leq 10\text{KW}$	$\leq 12\text{KW}$	$\leq 15\text{KW}$	$\leq 18\text{KW}$
温度设置范围 Temp range	0-950 $^{\circ}\text{C}$	0-950 $^{\circ}\text{C}$	0-950 $^{\circ}\text{C}$	0-950 $^{\circ}\text{C}$	0-950 $^{\circ}\text{C}$
转盘直径 Turntable diameter	$\Phi 340\text{mm}$	$\Phi 400\text{mm}$	$\Phi 510\text{mm}$	$\Phi 560\text{mm}$	$\Phi 700\text{mm}$
炉膛温度控制精度 Chamber temp tolerance	$\pm 5^{\circ}\text{C}$	$\pm 1^{\circ}\text{C}$	$\pm 1^{\circ}\text{C}$	$\pm 1^{\circ}\text{C}$	$\pm 1^{\circ}\text{C}$
炉膛钢盅数量 (无法兰) Interiuro flasks quantity (Without flange)	9个/Pcs 4"×10"	17个/Pcs 4"×10"	15个/Pcs 4"×8" 15个/Pcs 4"×12"	37个/Pcs 4"×10"	25个/Pcs 4"×8" 24个/Pcs 4"×12"
整机尺寸 Machine size	940×897×1990mm	1020×920×2065mm	1207×1011×2305mm	1210×1090×2285mm	1357×1233×2356mm
总量 Weight	/	520Kg	/	720Kg	/

开粉焙烧操作流程
Casting powder mixing and burn operation



1、按比例称好所需的水和石膏粉。
1. Weigh water and investment powder according to the proportion.



2、将装好蜡树的钢盅置入不锈钢自动真空搅粉机下桶并调整位置使其对准出粉口。
2. Put wax tree into flask, then put flask inside down chamber of vacuum mixer, then adjust the position of flask to make it right under the injection valve.



3、依次将水和石膏粉倒入不锈钢自动真空搅粉机上桶并盖上盖子。
3. Pour water and investment powder into the up chamber of automatic vacuum mixer and then cover on.



4、启动搅粉机开关进行搅粉，待搅粉均匀后拉出出粉口把手将搅好的石膏粉浆注入各个钢盅。
4. Starting mixing, after stirring the powder evenly, open the valve and inject mixed power into each flask.



5、将注满石膏粉浆的钢盅取出放在干燥的地方自然烘干。
5. Take flasks which are filled with investment out then put them on a dry & flat place to let it dry naturally.



6、将烘干的钢盅放入不锈钢电炉内焙烧，待钢盅内的蜡充分燃烧蒸发后即可取出进行铸造。
6. Put the dried flask into stainless steel oven to heat, wait until wax is fully burned or evaporated, finally take out investment mold to start casting.

熔炼铸造
Melting and casting

手提熔炼炉
MF series Electrical melting furnace

产品特点:

本机采用固态继电器输出控制，熔点为1900°C高温合金发热丝，耐高温合成材料制作的炉胆，以及高铝保温材料等一系列先进的高质量配件使得比市场同类机器使用寿命长，工作效率高。

PRODUCT FEATURES:

MF series apply SSR controller, alloy made heating element which has melting point up to 1900°C, high temp proof ceramic melting chamber, high aluminium protection and other advanced, top quality components, in addition to unique design, all consolidate furnace's durability and working efficiency over current markets furnaces.

最高温度
Max temp of machine
1150°C



橙色 Orange



黑色 Black



红色 Red



金色 Golden

技术参数 TECHNICAL PARAMETERS:

名称 Description	MF-1000手提熔金炉 1 kg melting furnace	MF-2000手提熔金炉 2 kg melting furnace	MF-3000手提熔金炉 3 kg melting furnace	MF-5000手提熔金炉 5kg melting furnace
型号 Model	M.MF.01000B / R	M.MF.02000B / R	M.MF.03000B / R	M.MF.05000B / R
功率 Power input	1750W	1750W	2050W	2800W
电源 Power supply	110V 50/60Hz, 14A 220V 50/60Hz, 7A	110V 50/60Hz, 14A 220V 50/60Hz, 7A	110V 50/60Hz, 14A 220V 50/60Hz, 7A	220V 50/60Hz, 7A
误差 Measurement accuracy	±0.5% FS	±0.5% FS	±0.5% FS	±0.5% FS
工作环境 Working environment	0~50°C, 30~85% RH	0~50°C, 30~85% RH	0~50°C, 30~85% RH	0~50°C, 30~85% RH
内部尺寸 (长×宽×高) Net size (L×W×H)	35x25x38cm	35x25x38cm	35x25x38cm	35x29.5x43.5cm
外部尺寸 (长×宽×高) Packing size (L×W×H)	38.5x38.5x44cm	38.5x38.5x44cm	38.5x38.5x44cm	41x41x51cm
净重 Net weight	10.5 kg	10.5 kg	10.5 kg	18.5 kg
毛重 Packing weight	12 kg	12 kg	12 kg	21 kg



熔炼铸造
Melting and casting



双环石墨熔炼坩埚
Graphite melting crucible with neck

名称 Description	型号 Model	重量 Weight	尺寸 Size (mm)				
			Φ1	Φ2	Φ3	H1	H2
1公斤双环石墨熔炼坩埚 1 kg graphite melting crucible with neck	G.GM.1000SH	245g	65	38	50	125	115
2公斤双环石墨熔炼坩埚 2 kg graphite melting crucible with neck	G.GM.2000SH	330g	72	44	55	155	140
3公斤双环石墨熔炼坩埚 3 kg graphite melting crucible with neck	G.GM.3000SH	360g	75	50	60	170	150
5公斤双环石墨熔炼坩埚 5 kg graphite melting crucible with neck	G.GM.5000SH	900g	100	69	88	148	155



数字熔金炉 Digital Melting Furnace

数字熔金炉是一款数字化感应加热电源，加热速度极快，非常适合金属熔炼。采用全铝机箱框架结构，全铝外壳具有隔热优，散热快等特点，经过喷砂氧化处理，外观极具工业美感，整机轻巧便携，可随意调整安放位置，面板简洁，一键启动，操作简单。

The digital gold melting furnace is a digital induction heating power source with extremely fast heating speed, which is very suitable for metal melting. It adopts an all-aluminum chassis frame structure, the all-aluminum shell has the characteristics of excellent heat insulation and fast heat dissipation. With industrial aesthetics, the whole machine is light and portable, the placement position can be adjusted at will, the panel is simple, one-key start, easy to operate.

技术参数 TECHNICAL PARAMETERS

型号 Model	M.DMF.H.00002	M.DMF.H.00002-1
供电电压 Supply Voltage	220V 50/60HZ	220V 50/60HZ
加热功率 Heating Power	4KW	4KW
加热温度 Heating Temperature	≤1300°C	≤1150°C
熔金量 Melting capacity	2KG	2KG
熔金时间 Melting Time	3-5min	3-5min
冷却系统 Cooling System	内置薄膜泵 Built-in Film Pump	
尺寸 Size	400×250×289mm	400×250×289mm
净重 Net Weight	8KG	8KG

迷你熔金机 Mini gold melting machine

产品特点:

- 1、MM-F系列感应式熔金炉是熔炼金、银、铜、铍及有色金属材料的先进设备；
- 2、采用大功率双半导体模块技术，具有较强的输出功率，稳定性高；
- 3、具有过压、过流、欠水、过热等多种保护功能，故障率低，安全可靠；
- 4、熔炼温度，可数字设定，并具有保温功能；
- 5、100%全负载，24小时连续工作能力；
- 6、升温迅速，省电节能，熔炼成本低，性能价格比高；
- 7、柜式设计，体积小，重量轻，安装操作，简单方便。

PRODUCT FEATURES:

1. MM-F Series is advanced melting equipment for gold, silver, copper, beryllium and other non ferrous metal melting.
2. Apply IGBT technology, big output power, stable high efficiency.
3. With various protection as over voltage protection, over current protection, insufficient water protection over heating protection, safe and reliable.
4. Adjustable melting temp, digital display, good insulation.
5. 100% full load, 24 hours continuous working.
6. Quick temp rising, electricity saving, low melting cost with high cost efficiency.
7. Cabinet casing, compact design with small size and low weight, easy operation, simple and convenient maintainance.



1公斤迷你熔金机
1KG Mini Induction Melting Furnace



带温控面板
With temperature control

不带温控面板
Without temperature control

技术参数:

颜色: 橙色、蓝色
熔金量: 1kg、2kg
频率: 50/60Hz
保修: 1年
熔金时间: 3~4.5分钟
最高温度: 1300°C

TECHNICAL PARAMETERS:

Casing Color: Orange、Blue
Melting capacity: 1kg、2kg
Frequency: 50/60Hz
Warranty: 1 year
Melting speed: 3~4.5 min
Max temp of machine: 1300°C

熔金机 Gold melting furnace



产品特点:

- 1、熔化时间约为3-4.5分钟, 熔化效率高节电效果好, 过载能力强;
- 2、具有过压, 过流, 过热, 缺水, 缺相等多重保护设计, 故障自动停机保护;
- 3、进口双IGBT模块设计, 加热电源稳定耐用, 100%全负载, 24小时连续工作能力;
- 4、感应线圈不带电 安全可靠。

PRODUCT FEATURES:

1. Melting time is about 3-4.5 minutes, melting efficiency good power saving effect and strong overload energy;
2. It has overvoltage, overcurrent, overheating, lack of protection, lack of equal multiple protection design, and automatic shutdown protection in case of fault;
3. With dual IGBT module design, the heating power supply is stable and durable, with 100% full load and continuous operation capacity at 24 hours;
4. The induction coil is not charged, safe and reliable.

技术参数:

- 颜色: 橙色、蓝色
 熔金量: 1kg, 2kg, 2.5kg, 3kg, 4kg, 5kg, 5.5kg, 6kg, 8kg
 频率: 50/60Hz
 保修: 1年
 熔金时间: 3-4.5分钟
 最高温度: 1300°C

TECHNICAL PARAMETERS:

- Casing Color: Orange, Blue
 Melting capacity: 1kg, 2kg, 2.5kg, 3kg, 4kg, 5kg, 5.5kg, 6kg, 8kg
 Frequency: 50/60Hz
 Warranty: 1 year
 Melting speed: 3-4.5 min
 Max temp of machine: 1300°C



熔炼坩埚及发热装置
Melting crucible and heating device

技术参数 TECHNICAL PARAMETERS:

名称 Description	型号 Model	电压 Voltage	相数 Phase	功率 Power input	重量 Weight	尺寸 Size
1公斤迷你熔金机 1kg mini furnace	M.MF.ML001-1	AC220V, 50/60Hz	1	3kW	28 kg	58×33×30cm
2公斤迷你熔金机 2kg mini furnace	M.MF.ML001-1	AC220V, 50/60Hz	1	5kW	29 kg	58×33×30cm
1公斤熔金机 1 kg melting furnace	M.MF.00001A-1	220/380V, ±15%	1/3	5kW/10kW	80 kg	50×50×95cm
2公斤熔金机 2 kg melting furnace	M.MF.00002A-1	220/380V, ±15%	1/3	5kW/10kW	80 kg	50×50×95cm
2.5公斤熔金机 2.5 kg melting furnace	M.MF.00025	220/380V, ±15%	1/3	5kW/10kW	80 kg	50×50×95cm
3公斤熔金机 3 kg melting furnace	M.MF.00003A-1	220/380V, ±15%	1/3	5kW/12kW	80 kg	50×50×95cm
4公斤熔金机 4 kg melting furnace	M.MF.00004A-1	220/380V, ±15%	1/3	5kW/12kW	80 kg	50×50×95cm
5公斤熔金机 5 kg melting furnace	M.MF.00005A-1	380V, ±15%	3	12kW	80 kg	50×50×95cm
5.5公斤熔金机 5.5kg melting furnace	M.MF.00055	380V, ±15%	3	12kW	80 kg	50×50×95cm
6公斤熔金机 6 kg melting furnace	M.MF.00006A-1	380V, ±15%	3	15kW	80 kg	50×50×95cm
8公斤熔金机 8 kg melting furnace	M.MF.00008A-1	380V, ±15%	3	15kW	80 kg	50×50×95cm



臻熔PRO熔金机 Premium-PRO Melting Furnace

臻熔PRO熔金机是一款操作简便的感应加热电源[注册商标DSPower®]，加热频率非常适合金属熔炼，可进行1400°C高温合金熔炼，铸造件成色度高，通过手动调节旋钮控制加热功率，操作简单。

The simple version melting machine is an easy-to-operate induction heating power supply (Registered Trademark: DSPower®). Its heating frequency is exceptionally suitable for metal smelting, capable of melting high-temperature alloys up to 1400°C. The resulting castings exhibit high color purity, and heating power is manually controlled via an adjustment knob for simple operation.

技术参数 TECHNICAL PARAMETERS

型号 Model	M.DF.00002F	M.DF.00003F	M.DF.00004F	M.DF.00005F	M.DF.00006F	M.DF.00008F
电压 Voltage	三相 (3 phase) 380V / 220V 50/60Hz			三相 (3 phase) 380V 50/60Hz		
功率 Power input	12kW	12kW	15kW	15kW	20kW	20kW
加热温度 Heating Temperature	≤1400°C					
冷却系统 Cooling system	3P水冷机 Water chiller 3P			5P水冷机 Water chiller 5P		
尺寸 Size	530×530×960mm					
重量 Weight	80-90KG					



1-3KG有法兰
1-3kg with flange

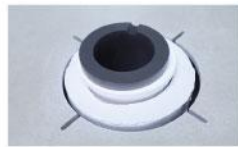

4-8KG没有法兰
4-8kg flangless

数显熔金机 Digital display gold melting machine

- 1、DF系列熔金机是一款数字化感应加热电源[注册商标DSPower®]；
- 2、加热频率非常适合金属熔炼，可进行1400°C高温合金熔炼；
- 3、精准的自整定PID控温系统，搅拌能力强；
- 4、铸造件成色度高，手势滑动液晶屏，可中英文切换，操作简单。

1. DF Series Gold melting machine is a digital induction heating power supply [registered trademark DSPower®];
2. The heating frequency is very suitable for metal melting, which can be used for 1400 °C superalloy melting;
3. Accurate self-tuning PID temperature control system, strong mixing ability;
4. The casting has high chromaticity, gesture sliding LCD screen, Chinese and English switching, and simple operation.

技术参数 TECHNICAL PARAMETERS

型号 Model	M.DF.00002E	M.DF.00003E	M.DF.00004E	M.DF.00005E	M.DF.00006E	M.DF.00008E
电压 Voltage	三相 (3 phase) 380V / 220V 50/60Hz			三相 (3 phase) 380V 50/60Hz		
功率 Power input	12kW	12kW	15kW	15kW	20kW	20kW
加热温度 Heating temperature	≤1400°C					
冷却系统 Cooling system	3P水冷机 Water chiller 3P			5P水冷机 Water chiller 5P		
尺寸 Size	500×500×888mm					
重量 Weight	80-100KG					

铂金熔金机 Platinum melting furnace

产品特点:

通过感应发热原理直接对金属进行加热使固态金属熔化成液态，无需石墨坩埚等容器进行能量转换，故具有能量损耗低，升温快等特点。本机线路采用了弱电控制强电的控制方式，以此减少漏电伤人。

PRODUCT FEATURES:

The metal is directly heated by the principle of induction heating to melt the solid metal into a liquid state, and does not require a container such as a graphite crucible for energy conversion, so that the energy loss is low and the temperature rises quickly. The wires of the machine adopts the control method of weak electric control strong electric power to reduce leakage and injure people.

技术参数 TECHNICAL PARAMETERS:

型号 Model	M.MF.P0001	M.MF.P0002	M.MF.P0003	M.MF.P0004
电源 Power supply	三相380V, 50/60Hz			
功率 Power input	15KW	15KW	25KW	25KW
容量 Capacity	1KG	2KG	3KG	4KG
熔化速率 Melting speed	3~5min			
重量 Weight	106kg			
尺寸 Size	550x500x983mm			



1公斤石英底座
1kg Ceramic base

型号 Model: C.CD.01000



4公斤石英底座
4kg Ceramic base

型号 Model: C.CD.04000



石英盖 Ceramic cover

型号 Model	规格 Size
C.CA.85026	1kg $\Phi 85 \times H26\text{mm}$
C.CA.96026	2kg $\Phi 99 \times H26\text{mm}$
C.CA.112028	3kg $\Phi 112 \times H28\text{mm}$
C.CA.116028	4kg $\Phi 116 \times H28\text{mm}$
C.CA.134032	5kg $\Phi 134.5 \times H32\text{mm}$
C.CA.145032	6kg $\Phi 145 \times H32\text{mm}$
C.CA.164035	8kg $\Phi 164 \times H35\text{mm}$



石英接料环 Ceramic Cup

型号 Model	规格 Size
C.CC.131048	1-3kg $\Phi 131 \times H48\text{mm}$
C.CC.195048	4-5kg $\Phi 195 \times H48\text{mm}$
C.CC.230048	6-8kg $\Phi 230 \times H48\text{mm}$



K型熔金机热电偶
K type thermo couple

型号 Model: T.TC.K0002
规格 Specification: 0-1300°C

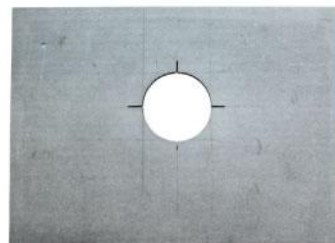

耐火盖板
Asbestos board

型号 Model: M.MF.QP002

熔炼坩埚套件
Induction crucible set

名称 Description	型号 Model	重量 Weight (g)	尺寸 Size (mm)			
			Φ1	Φ2	Φ3	H
1kg石墨熔炼坩埚 1 kg graphite crucible	G.GM.1000A	155	58	35	47	88
1kg石英外套 1 kg ceramic shield	C.CC.1000A	170	70	51	59	89
2kg石墨熔炼坩埚 2 kg graphite crucible	G.GM.2000A	245	65	44	57	110
2kg石英外套 2 kg ceramic shield	C.CC.2000A	270	84	61	70.5	112
2.5kg石墨熔炼坩埚 2.5 kg graphite crucible	G.GM.2500A	290	65	44	57	126
2.5kg石英外套 2.5 kg ceramic shield	C.CC.2500A	320	84	61	71	127
3kg石墨熔炼坩埚 3 kg graphite crucible	G.GM.3000A	385	85	60	75	105
3kg石英外套 3 kg ceramic shield	C.CC.3000A	335	97	79	89	103
4kg石墨熔炼坩埚 4 kg graphite crucible	G.GM.4000A	465	85	60	76	131
4kg石英外套 4 kg ceramic shield	C.CC.4000A	370	100	80	90	132
5kg石墨熔炼坩埚 5 kg graphite crucible	G.GM.5000A	650	100	69	89	131
5kg石英外套 5 kg ceramic shield	C.CC.5000A	700	118.5	92	100.5	135
5.5kg石墨熔炼坩埚 5.5 kg graphite crucible	G.GM.5500A	820	105	70	90	156
5.5kg石英外套 5.5 kg ceramic shield	C.CC.5500A	600	122	94	107	155
6kg石墨熔炼坩埚 6 kg graphite crucible	G.GM.6000A	1210	115	79	97	178
6kg石墨熔炼坩埚 6 kg graphite crucible	G.GM.6000B	1135	115	79	100	180
6kg石英外套 6 kg ceramic shield	C.CC.6000A	725	127	100	113	178
6kg石英外套 6 kg ceramic shield	C.CC.6000B	800	128	104	116	181
8kg石墨熔炼坩埚 8 kg graphite crucible	G.GM.8000B	1505	120	84	110	181
8kg石英外套 8 kg ceramic shield	C.CC.8000B	920	143	112	132	182

熔炼铸造
Melting and casting



石墨熔炼坩埚套件
Induction crucible set



倾倒式熔金机 Tilting Melting Furnace

产品特点:

- 1、熔化时间约为8-10分钟;
- 2、采用大功率半导体模块技术, 具有较强的输出功率, 稳定性高;
- 3、具有过压, 过流, 过热, 缺水; 缺相等多种保护功能;
- 4、升温迅速, 省电节能, 熔炼成本低;
- 5、本机采用大功率高频感应加热方法熔炼, 既有快速加热又有对金属进行电磁搅拌的功能, 以获得温度与成分高度均匀的金属液。

PRODUCT FEATURES:

1. Melting speed: 8-10min.
2. Use of high power semiconductor model technology, It has strong output power and high stability
3. With various protection as over voltage, over current, shortage water, overheating.
4. Quick temp rising, electricity saving, low melting cost.
5. The machine adopts high power and high frequency induction heating method. It has the function of fast heating and electromagnetic stirring to obtain metal liquid with high temperature and composition.

技术参数 TECHNICAL PARAMETERS

名称 Description	型号 Model	电压 Voltage	石英外套 Ceramic shield	石墨坩埚 Graphite crucible	重量 Weight	尺寸 Size
12公斤倾倒式熔金机 12KG Tilting Melting Furnace	M.MF.T0012	380V/3Phase/15KW	Φ158x205mm	Φ146x208mm	180kg	1004x772x1355mm
20公斤倾倒式熔金机 20KG Tilting Melting Furnace	M.MF.T0020	380V/3Phase/25KW	Φ207x250mm	Φ186x248mm	203kg	1080x785x1400mm
40公斤倾倒式熔金机 40KG Tilting Melting Furnace	M.MF.T0040	380V/3Phase/25KW	Φ215x260mm	Φ198x255mm	205kg	1080x780x1400mm
50公斤倾倒式熔金机 50KG Tilting Melting Furnace	M.MF.T0050	380V/3Phase/45KW	Φ200x213mm	Φ175x250mm	239kg	1080x780x1400mm

迷你铸造机 Mini casting machine

技术参数 TECHNICAL PARAMETERS:



名称 Description	4L迷你铸造机 4L mini casting machine	8L迷你铸造机 8L mini casting machine
型号 Model	M.CM.00004	M.CM.00008
电源 Power supply	220V, 50Hz, 1 phase	220V, 50Hz, 1 phase
功率 Power input	1.5kW	1.5kW
真空泵 Vacuum pump capacity	4L / 3Pa	8L / 5Pa
钢盅直径 Suitable diameter of flask	2.5", 3.5", 4"	2.5", 3.5", 4"
钢盅高度 Suitable height of flask	≤8"	≤8"
重量 Weight	54.5kg	53.5kg
尺寸 Size	630×340×880mm	630×340×880mm

适用范围: 抽真空、吸索铸造

Application: Vacuum, suck-type casting

真空吸索铸造机 Suck-type casting machine

技术参数 TECHNICAL PARAMETERS:



Z.M.CM.00009

型号 Model	M.CM.00005	M.CM.00009	M.CM.00020
电源 Power supply	380V, 50Hz, 3 phase	380V, 50Hz, 3 phase	380V, 50Hz, 3 phase
功率 Power input	1.5kW	2kW	5.5kW
真空泵 Vacuum pump capacity	15L/30L	15L/30L	70L/100L
钢盅直径 Suitable diameter of flask	3.5", 4", 5"	5", 6.3", 8.6"	10", 15", 20"
钢盅高度 Suitable height of flask	≤10"	≤10"	≤24"
重量 Weight	75kg	102.5kg	200kg
尺寸 Size	590×590×750mm	590×800×750mm	835×970×1020mm

备注:

- 1、可定制220V/单相。
- 2、可定制更大规格吸索铸造机。

REMARK:

1. 220V/1 phase tailored.
2. Suck-type casting machines with greater specifications can be customized.

抽真空机 Vacuum mixer

技术参数:

型号: M.VM.00001
重量: 80kg
功率: 300W
电压: 380V
台面尺寸: 500x500mm
外形尺寸: 550x850x890mm

TECHNICAL PARAMETERS:

Model: M.VM.00001
Weight: 80kg
Power input: 300W
Voltage: 380V
Table size: 500x500mm
Size: 550x850x890mm



真空罩
Vacuum hood



操控面板
Operation pannel

熔炼铸造操作流程 Melting and casting operation process



1、将金属材料置入熔金机中的熔炼坩埚中进行高温熔化。
1. The melting metal materials in molten gold machine in high temperature melting.



2、金属熔炼接近完成时将吸索铸造机“抽真空”打开，然后将焙烧脱腊完成的钢盅放入铸造机中。
2. Metal smelting is close to completion will blister casting machine "vacuum" open, then the steel cup baking finish into dewaxing casting machine.



3、待吸索铸造机不漏气时打开“倒模”，再将熔好的金属液体缓缓倒入石膏模具里面。
3. The blister casting machine does not leak when open "mold", metal liquid and then melted slowly into the plaster mold.



4、等待一分钟，关真空、排气，取出钢盅。
4. Wait a minute, close the vacuum, exhaust, remove the steel cup.



5、没有蜡镶的物品要泡水，有蜡镶的物品需用压粉机压出。
5. No wax embedded items must be soaked in water, with wax inlay items by the powder pressing machine pressure.



6、取出铸件放入石膏清洗机里面清洗干净。
6. Remove the plaster casting into the washing machine inside clean.



压粉装置
Press powder device



操控面板
Operation pannel



压粉机
Investment remover

压粉机 Investment Remover

产品特点 PRODUCT FEATURES:

本机特别适用于蜡镶铸造时低温脱石膏模的工序，只需将带石膏模的钢铃放在加压柱下，几秒钟便可将石膏模从钢铃中推出，省时省力，操作十分简便方便。

This product is more suitable for low temp investment remove, put the flasks under the press plunger, after few minutes you can take out the flaks, time saving, convenient operation.

技术参数 TECHNICAL PARAMETERS:

型号 Model	M.IR.00040-A/B		M.IR.00050-A/B	
	A	B	A	B
规格 Specification	4"×4"	4"×4"	5"×4"	5"×4"
	4"×5"	4"×5"	5"×5"	5"×5"
	4"×6"	4"×6"	5"×6"	5"×6"
	4"×7"	4"×7"	5"×7"	5"×7"
	4"×8"	4"×8"	5"×8"	5"×8"
	4"×9"	4"×9"	5"×9"	5"×9"
		4"×10"		5"×10"
		4"×11"		5"×11"
电源 Power supply	380V, 50/60Hz, 3 phase			
功率 Power input	1.5kW			
重量 Weight	130kg		142kg	

真空加压铸造机
Vacuum pressure casting machine



M.CM.AVC-EV

M.CM.AVC-II

M.CM.AVC-III

支持多种规格钢盅及无边钢盅，最大钢盅规格6.3"x10"
Workable for many kinds of flasks: with flange, without flange, maximum flask size is 6.3"x10"

产品特点:

- 1、核心配件均采用SMC、富士、施耐德等一线品牌，确保设备精度，减少故障率。
- 2、拥有1000组工作程序，满足工厂不同的产品生产需要。
- 3、采用水电隔离的设计，降低设备故障。
- 4、设备尺寸符合人体工学，操作便捷。
- 5、有或者无法兰的钢盅都可以使用，减少转换使用成本。
- 6、可选配德国真空泵和水冷系统。
- 7、产品通过欧盟CE认证。

PRODUCT FEATURES:

1. Use first-line brands core parts like SMC, Fuji, Schneider and other to ensure equipment accuracy and reduce the failure rate.
2. 1000 memory program to meet various production needs of the factory.
3. Water and electricity isolation design reduces equipment failure
4. Machine size design accords with ergonomics
5. Suitable for flask with or without flange, lower conversion costs.
6. Optional German vacuum pump and water cooling system
7. With CE certification.

技术参数 TECHNICAL PARAMETERS:

型号 Model	M.CM.AVC-EV	M.CM.AVC-II	M.CM.AVC-III
电源 Power supply	380V/50Hz/3PH		
输出功率 Power output	15KW		
金属类别 Suitable metal	金、银、铜 Gold, Silver, Copper		
金属容量 Melting capacity	2.5kg		
温度范围 Temp. range	标配 Standard: 0~1150°C K型 (K type) \ 选配 Option: 0~1450°C R型 (R type)		
最大加压压力 Max pressure	0.2Mpa		
气体 Protection gas	氩气或氮气 Argon or Nitrogen		
冷却方式 Type of cooling	水冷式 Water-cooling		
铸造方式 Casting method	真空吸泵加压方式 Vacuum pressure casting		
异常警告 Abnormal warning	自我诊断LED显示 Self-diagnostic LED display		
环境温度 Environmental temp.	5°C~40°C		
真空装置 Vacuum setting	外置100m ³ /H以上真空泵 External vacuum pump more than 100m ³ /H		
供水 Water Supply	10°C~30°C, 推荐使用3P水冷机 10°C~30°C, and better use the water chiller more than 3P		
机身尺寸 Machine dimension	750x660x1260mm	750x700x1220mm	750x700x1220mm
净重 Net weight	226KG	242KG	230KG

台面式迷你铸造机 Mini Vacuum Pressure Casting Machine

产品特点:

- 1、迷你机身，占地空间小全自动操作，适合首饰DIY工作室，打金铺小型首饰工作坊等，是一款专为小型加工场所而制造的好帮手。
- 2、独特强劲的电磁搅拌功能，使熔解金属成色更均匀。
- 3、感应式加热，智能化程度高。
- 5、可直观方便地观察熔解铸造全过程，气压式自锁定系统，设有安全控制阀门，确保人机安全。
- 6、真空状态下熔解铸造，将氧化物控制在最低限。
- 7、可选择多种规格铸筒。
- 8、完善的自身报警系统，如遇异常现象，即时停机，最大限度地维护机身内部系统。
- 9、特设铸造室，分抽真空装置，将气泡排出到最低点。
- 10、铸造室最大耐压0.6MPa，正常加压0.2MPa，真空压强为负0.1MPa。

PRODUCT FEATURES:

1. Compact design, saving space and fully automatic operation. Suitable for small amount casting and first choice for jewelry DIY, workshop, goldsmith etc.
2. Strong electromagnetic stirring to ensure metal with even color.
3. Induction heating, high intelligence.
5. Whole casting process can visually seen, air pressing lock system, equipped with safety valve to ensure safety.
6. Both melting and casting are done under vacuum condition, maximally control oxidation.
7. Various casting cylinder is for option.
8. Various alarm system, unit stops working immediately if any error detected, maximally protect machine.
9. Unique casting cylinder separated from vacuum device, to reduce bubble to minimum.
10. Max pressure of casting chamber is 0.6MPa, normal pressure is 0.2 MPa, max compact is minus 0.1MPa.



支持多种规格无边钢盅，最大钢盅规格4"x6"
Support flasks without flange, maximum flask size is 4"x6"

熔炼铸造
Melting and casting

技术参数 TECHNICAL PARAMETERS:

型号 Model	M.CM.SVC 2024	
电源 Power supply	220V/50Hz/1PH	
输出功率 Power output	6KW	
金属类别 Suitable metal	金、银、铜 Gold, Silver, Copper	
金属容量 Melting capacity	1kg	
温度范围 Temp. range	标配 Standard: 0-1150°C K型 (K type) \ 选配 Option: 0-1450°C R型 (R type)	
最大加压压力 Max pressure	0.2Mpa	
气体 Protection gas	氩气或氮气 Argon gas or Nitrogen oxides	
冷却方式 Type of cooling	水冷式 water-cooled	
铸造方式 Casting method	真空吸索加压方式 Vacuum pressure casting	
异常警告 Abnormal warning	自我诊断LED显示 Self-diagnostic LED display	
环境温度 Environmental temp.	5°C-40°C	
真空装置 Vacuum setting	另置8L以上真空泵 match the vacuum pump more than 8L	
供水 Water Supply	10°C到30°C，推荐使用1P水冷机 10°C-30°C, and better use the water chiller more than 1P	
箱体尺寸 Box size	540×460×412mm	选配 Option
箱体重量 Box weight	45KG	
机身尺寸 Machine size	540×510×760mm	
机身重量 Machine weight	103KG	



M.CM.DVC-III

支持多种规格钢盅及无边钢盅，最大钢盅规格**6.3"x10"**
Workable for many kinds of flasks: with flange, without flange,
maximum flask size is **6.3"x10"**



M.CM.DVC-II

支持多种规格钢盅及无边钢盅，最大钢盅规格**6.3"x10"**
Workable for many kinds of flasks: with flange, without flange,
maximum flask size is **6.3"x10"**

自动真空加压铸造机 Automatic vacuum pressure casting machine

产品特点:

- 1、核心配件均采用SMC、富士、施耐德等一线品牌，确保设备精度，减少故障率。
- 2、产品设计合理，特别配备调整钢盅托架，减少操作步骤。
- 3、产品采用触摸屏控制，配有中英文可转换界面，操作简单。真空、压力等时间可调，根据铸件随意调节参数。
- 4、拥有1000组工作程序，满足工厂不同的产品生产需要。
- 5、采用水电隔离的设计，降低设备故障。
- 6、设备尺寸符合人体工学，操作便捷。
- 7、有或者无法兰的钢盅都可以使用，减少转换使用成本。
- 8、可选配德国真空泵和水冷系统。
- 9、产品通过欧盟CE认证。

PRODUCT FEATURES:

1. Use first-line brands core parts like SMC, Fuji, Schneider and other to ensure equipment accuracy and reduce the failure rate.
2. Reasonable design and equipped with a special flask holder to make it easy for operating.
3. Easy operation:
Touch screen control.
Two languages: Chinese and English.
Parameters of vacuum, pressure and time can be adjusted according to the castings.
4. 1000 memory program to meet various production needs of the factory.
5. Water and electricity isolation design reduces equipment failure
6. Machine size design accords with ergonomics
7. Suitable for flask with or without flange, lower conversion costs.
8. Optional German vacuum pump and water cooling system
9. With CE certification.

▶ 铸件 Casting piece





M.CM.DVC-L



250mm

180mm

熔炼铸造
Melting and casting

支持多种规格钢盅及无边钢盅，最大钢盅规格8.6"x14"
Workable for many kinds of flasks: with flange, without flange, maximum flask size is 8.6"x14"

技术参数 TECHNICAL PARAMETERS:

型号 Model	M.CM.DVC-II	M.CM.DVC-III	M.CM.DVC-L
电源 Power supply	380V/50Hz/3PH		
输出功率 Power output	15KW	15KW	25KW
金属类别 Suitable metal	金、银、铜 Gold, Silver, Copper		
金属容量 Melting capacity	2.5kg	2.5kg	8kg
温度范围 Temp. range	标配 Standard: 0-1150°C K型 (K type) \ 选配 Option: 0-1450°C R型 (R type)		
最大加压压力 Max pressure	0.2Mpa		
气体 Protection gas	氩气或氮气 Argon or Nitrogen		
冷却方式 Type of cooling	水冷式 Water-cooling		
铸造方式 Casting method	真空吸索加压方式 Vacuum pressure casting		
异常警告 Abnormal warning	自我诊断LED显示 Self-diagnostic LED display		
环境温度 Environmental temp.	5°C-40°C		
真空装置 Vacuum setting	外置100m ³ /H以上真空泵 External vacuum pump more than 100m ³ /H		内置40m ³ /H以上真空泵 Internal vacuum pump more than 40m ³ /H
供水 Water Supply	10°C-30°C, 推荐使用3P水冷机 10°C-30°C, and better use the water chiller more than 3P		10°C-30°C, 推荐使用5P水冷机 10°C-30°C, and better use the water chiller more than 5P
机身尺寸 Machine dimension	750×660×1260mm	750×660×1260mm	850×770×1420mm
净重 Net weight	243.5KG	256KG	347KG



D5自动真空加压铸造机 D5 Automatic vacuum pressure casting machine

产品特点:

D5用于自动混合金属，制作合成金，通过惰性气体的保护熔化过程，机器在真空下浇注。

- 1、全密封内部机箱设计，确保元器件不受外部环境影响，无粉尘干扰，保证使用寿命；
- 2、核心配件采用国际一线大品牌，设备性能更加稳定可靠；
- 3、标配进口测温针，测温误差小且不易烧坏；
- 4、整机所有气管及水路接头均采用304不锈钢，用料扎实
- 5、熔炼室、浇铸室和气缸全部采用CNC一体加工成型，精度更高，稳定性和耐用性达国际一流水平。

DESCRIPTION:

D5 is used for automatic mixing of metals, made into synthetic gold, protected by a inert gas melting process, and the machine is poured under vacuum.

MAIN FEATURE:

1. High-powered intermediate frequency power supply is heated, and heating can automatically stir the molten metal to improve the uniformity of the alloy.
2. Easy to operate: touch LCD display and adjustment parameters, button control equipment.
3. The equipment has a variety of operating modes, the manufacturer presets the conventional casting parameters and user-defined casting parameters, the parameters have a sequential storage function, suitable for a variety of metal casting.
4. The zinc metal casting procedure is optional, and the equipment automatically adjust to reduce the evaporation of zinc metal while reducing the shrinkage rate of the casting.
5. The advanced temperature regulation and precise alloy temperature control, suitable for K/R type thermocouple temperature probe.

支持多种规格无边钢盘，最大钢盘规格5"x16"
Support flasks without flange, maximum flask size is 5"x16"

技术参数 TECHNICAL PARAMETERS:

型号 Model	M.CM.D5
电源 Power supply	380V/50Hz/3PH
功率 Power	15KW
金属类别 Metal	金、银、铜 Gold, Silver, Copper
金属熔量 Metal melting capacity	4kg
温度范围 Temperature range	标配 Standard: 0~1150°C K型 (K type) 选配 Option: 0~1450°C R型 (R type)
尺寸 Size	750×700×1400mm
重量 Weight	280kg



DVC-30自动真空加压铸造机

DVC-30 Automatic vacuum pressure casting machine

DVC-30是一款程序完全开放式，用户可自由编程满足各种工艺、多功能性的真空加压铸造机，适合高温合金铸造，控温精准 $\pm 3^{\circ}\text{C}$ ，实测损耗小，铸件成色高。自动诊断系统，铸造系统可靠性高，如钢盅真空漏气不进行铸造且自动提示，等多项保护。

DVC-30 is a vacuum pressure casting machine with completely open program, users can freely program to meet various processes and multi-functions, it is suitable for superalloy casting, the temperature control is accurate $\pm 3^{\circ}\text{C}$, the measured loss is small and the casting pieces are of high quality. Automatic diagnosis system, high reliability of the casting system, such as vacuum leakage of the flask, no casting and automatic reminder and many other protections.



钢盅类型：有边法兰钢盅，最大放置 $\Phi 500 \times H600\text{mm}$ 钢盅
Flask type: flask with flange, maximum $\Phi 500 \times H600\text{mm}$

技术参数 TECHNICAL PARAMETERS

型号 Model	M.CM.DVC-30
供电 Power supply	380V/50Hz/3PH/45KW
温度范围 Temperature range	标配 Standard: 0-1150 $^{\circ}\text{C}$ K型 (K type) \ 选配 Option: 0-1450 $^{\circ}\text{C}$ R型 (R type)
控温精度 Temperature control accuracy	$\pm 3^{\circ}\text{C}$
冷水机配置 Chiller	8P/10P
真空泵 Vacuum pump	内置 Built-in 100L
空压机气压 Air compressor pressure	500KPa
加热功率 Heating power	0-45KW 自动调配 Automatic allocation
钢盅尺寸 Flask size	D500 \times H600mm
保护气 Protective gas	氩气/氮气，系统参数设置压力 $\leq 50\text{KPa}$ ，设备输入保护气压力200KPa Argon/nitrogen, system parameter setting pressure $\leq 50\text{KPa}$, equipment input protective gas pressure 200KPa
机身尺寸 Body size	1120 \times 1220 \times 1700mm
净量 Net weight	902KG

AVC/DVC系列易损件
AVC/DVC Series Consumable Parts



DVC-II投料盖
DVC-II Ceramic cover
型号 Mode: IC.CC.AVC-E
尺寸 Size: $\Phi 208 \times 50$ mm



AVC-G铸造机石英外套
AVC-G Casting Machine
Ceramic Shiled
型号 Mode: C.CC.AVC-G
尺寸 Size: $\Phi 88 \times 120$ mm



AVC-F 铸造机石英底座
AVC-F Casting Machine
Ceramic Base
型号 Mode: C.CC.AVC-F
尺寸 Size: $\Phi 87 \times 35$ mm



DVC铸造桶石英外套
DVC Casting Barrel
Ceramic Shiled
型号 Mode: C.CC.DVC01
尺寸 Size: $\Phi 78 \times 130$ mm



石墨坩埚
Graphite Crucible
型号 Mode: G.GC.DVC-II.01A
尺寸 Size: $\Phi 15 \times 145$ mm



石墨塞棒
Graphite Stopper Rod
型号 Mode: G.GS.DVC-II.01A
尺寸 Size: $\Phi 68 \times 70$ mm



石墨接料杯
Graphite Receiver Cup
型号 Mode: G.GP.DVC-II.01A
尺寸 Size: $\Phi 165 \times 273$ mm



高温垫
High-Temperature Gasket
型号 Mode: R.SR.00059-B
尺寸 Size: $\Phi 160 \times \Phi 49 \times H8$ mm



线圈
Heating Coil
型号 Mode: M.CM.CC003.00.00.34
尺寸 Size: $\Phi 100 \times 116$ mm



热电偶
Thermocouple
型号 Mode: WG.DQ.021.052
尺寸 Size: $\Phi 4 \times 180 \times 120$ mm



O型密封圈
O-Sealing ring
型号 Mode: WG.MF. 003.189
尺寸 Size: 内径 Inner Diameter $\Phi 206 \times \Phi 7$ mm

SVC易损件
SVC Consumable Parts



SVC投料盖
SVC Ceramic cover
型号 Mode: C.CC.SVC01
尺寸 Size: $\Phi 127 \times 47$ mm



SVC石英外套
SVC Ceramic Shiled
型号 Mode: C.CC.SVC02
尺寸 Size: $\Phi 68 \times 96$ mm



石英垫板
Ceramic Base
型号 Mode: C.CD.065026
尺寸 Size: $\Phi 65 \times 50 \times 25 \times H26$ mm



石墨坩埚
Graphite Crucible
型号 Mode: G.GC.SVC.01A
尺寸 Size: $\Phi 56 \times 100$ mm



石墨塞棒
Graphite Stopper Rod
型号 Mode: G.GS.SVC.01A
尺寸 Size: $\Phi 12 \times 121 \text{mm}$



石墨接料杯
Graphite Receiver Cup
型号 Mode: G.GP.SVC.01A
尺寸 Size: $\Phi 58 \times 23 \text{mm}$



高温垫
High-Temperature Gasket
型号 Mode: M.CM.SVC.00.72
尺寸 Size: $\Phi 83.4 \times \Phi 60.4 \times 6 \text{mm}$



线圈
Heating Coil
型号 Mode: M.CM.SVC.00.05
尺寸 Size: $\Phi 85 \times 81 \text{mm}$



测温针
Thermocouple
型号 Mode: WG.DQ.011.053
尺寸 Size: $\Phi 2 \times 180 \times 150 \text{mm}$

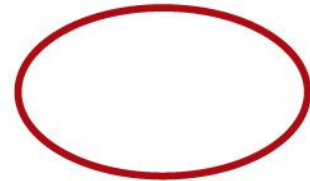

下桶密封圈
Sealing ring
型号 Mode: WG.MF.003.061
尺寸 Size: 内径 $\Phi 130 \times \Phi 5.3 \text{mm}$

其它易损件
Other Consumable Parts



石墨垫圈
Graphite gasket

名称 Description	型号 Model	尺寸 Size
3.5寸薄石墨垫圈 / 3.5" graphite gasket	G.GG.B0035W	$\Phi 120 \times \Phi 92 \times H2 \text{mm}$
3.5寸厚石墨垫圈 / 3.5" graphite gasket (thick)	G.GG.H0035W	$\Phi 120 \times \Phi 92 \times H5 \text{mm}$
4寸薄石墨垫圈 / 4" graphite gasket	G.GG.B0004W	$\Phi 139 \times \Phi 114 \times H2 \text{mm}$
4寸厚石墨垫圈 / 4" graphite gasket (thick)	G.GG.H0004W	$\Phi 139 \times \Phi 114 \times H5 \text{mm}$
5寸薄石墨垫圈 / 5" graphite gasket (thin)	G.GG.B0005W	$\Phi 158 \times \Phi 137 \times H2 \text{mm}$

高温石英观察片
High temp quartz sheet
型号 Model: M.CM.P0001





迷你离心旋转铸造机 Mini Centrifugal rotary casting machine

产品特点:

- 1、铸造PT铂金的效果非常显著，并可铸造少量的K金，银等；
- 2、温度检测采用进口红外探测仪；
- 3、铸造过程采用真空熔炼并可弹出氮气或者氩气等惰性气体将氧化物降至最低；
- 4、智能化操作系统，操作简单方便，中英文切换，自我诊断功能等；
- 5、内置真空装置，可设真空压力值；
- 6、感应加热线圈采用超低电压高频设计，确保安全，提高铸造效率。

PRODUCT FEATURES:

1. Centrifugal rotary casting machine can deliver an excellent effect on casting PT, Also for k gold and silver in small quantity.
2. Use imported infrared detector for temperature.
3. Vacuum in melting process to prevent oxidation with argon or nitrogen inside.
4. Intelligent operating system, simple and convenient, Chinese and English panel, self diagnosis function, etc.
5. With vacuum pump inside the machine which can be adjusted the pressure value.
6. Induction heating coil adopts low voltage and high frequency design to ensure safety and improve casting efficiency.

技术参数:

型号: M.CM.RCS150
 电源: 220V/50Hz
 功率: 4KW
 铸造方式: 真空离心旋转
 冷却方式: 水冷
 温度范围: 800~2000°C
 金属类别: PT, K金, 银
 真空装置: 外置
 钢盅尺寸: 3.5"x3"
 机身重量: 95kg
 外形尺寸: 540×528×748mm

TECHNICAL PARAMETERS:

Model: M.CM.RCS150
 Power supply: 220V/50Hz
 Power output: 4KW
 Casting way: Vacuum centrifugal rotation
 Cooling way: Water cooling
 TTemp. range: 800~2000°C
 Metal: PT, K gold, Silver
 Vacuum device: External
 Flask size: 3.5"x 3"
 Weight: 95kg
 Body size: 540x528x748mm

离心旋转铸造机 Centrifugal rotary casting machine



M.CM.RC150



M.CM.RC350

产品特点:

- 1、铸造PT铂金的效果非常显著，并可铸造少量的K金，银等。
- 2、温度检测采用进口红外探测仪。
- 3、铸造过程采用真空熔炼并可弹出氮气或者氩气等惰性气体将氧化物降至最低。
- 4、智能化操作系统，操作简单方便，中英文切换，自我诊断功能等。
- 5、内置真空装置，可设真空压力值。
- 6、感应加热线圈采用超低电压高频设计，确保安全，提高铸造效率。

PRODUCT FEATURES:

1. Centrifugal rotary casting machine can deliver an excellent effect on casting PT, Also for k gold and silver in small quantity.
2. Use imported infrared detector for temperature.
3. Vacuum in melting process to prevent oxidation with argon or nitrogen inside.
4. Intelligent operating system, simple and convenient, Chinese and English panel, self diagnosis function, etc.
5. With vacuum pump inside the machine which can be adjusted the pressure value.
6. Induction heating coil adopts low voltage and high frequency design to ensure safety and improve casting efficiency.

技术参数 TECHNICAL PARAMETERS:

型号 Model	M.CM.RC150	M.CM.RC350
供电要求 Power supply	220V/50Hz/1PH/4KW	220V/50Hz/1PH/6KW
压缩空气 Air Compress or Pressure	500KPa	
钢盅尺寸 Flask Size	Φ3.5"x3"	Φ4"x5"
金属熔量 Melting capacity	铂金 (PT) 150g	铂金 (PT) 350g
红外测温范围 Temperature range	490-2000°C	
冷却方式 CoolingType	水冷 Water-Cooled	
金属类别 Suitable Metal	铂金，不锈钢，金、银等 / PT, SS, Gold, Silver, etc	
铸造方式 CastingMethod	高速真空离心旋转 High Speed Vacuum Centrifugal Rotation	
机器尺寸 Machine Size	720x650x1060mm	750x740x1150mm
重量 Net Weight	152KG	185kg



离心铸造机 Centrifugal casting machine

产品特点:

- 1、独特的双摆臂结构，大幅度提高离心力。
- 2、驱动采用高性能伺服电机，提高旋转加速度与离心度。
- 3、在铸造PT铂金的效果非常显著，并可铸造少量的K金，银等。

PRODUCT FEATURES:

1. Unique double swing arm structure can increase the centrifugal force.
2. High performance servo motor is used to improve rotation acceleration and centrifugal force.
3. Centrifugal rotary casting machine can deliver an excellent effect on casting PT, Also for k gold and silver in small quantity.

技术参数 TECHNICAL PARAMETERS:

型号 Model	M.CM.CC350	M.CM.CC650	M.CM.CC1000
供电要求 Power supply	380V/50Hz/3PH/15KW		
压缩空气 Air Compress or Pressure	500KPa		
钢盅尺寸 Flask Size	Φ4"x5"	Φ4"x8"	Φ4"x7"
金属熔量 Melting capacity	铂金 (PT) 350g	铂金 (PT) 650g	铂金 (PT) 1000g
温度范围 Working Temp	800-2000°C		
冷却方式 CoolingType	水冷 Water-Cooled		
金属类别 Suitable Metal	铂金，不锈钢，金、银等 / PT, SS, Gold, Silver, etc		
铸造方式 CastingMethod	高速真空离心旋转 High Speed Vacuum Centrifugal Rotation		
机器尺寸 Machine Size	1020x860x1180mm	1030x897x1207mm	1030x897x1207mm
重量 Net Weight	405kg	/	410kg



M.CM.IC1000



M.CM.IC4000

铸锭机 Gold bar machine

产品特点:

M.CM.IC1000铸锭机适合1KG金条或者银条铸造，将石墨油槽放置在熔炼平台感应加热熔炼，熔炼和冷却都是真空和惰性气体保护环境下完成，避免金属和石墨模具氧化，惰性气体可为氮气或者氩气。

PRODUCT FEATURES:

M.CM.IC1000 gold bar machine is for casting 1kg gold bar or silver bar. Put the graphite ingot mould into the melting chamber. here is vacuum and protective air in melting and cooling process to avoid metal and graphite ingot oxidation . protective gas can be argon or nitrogen.



技术参数 TECHNICAL PARAMETERS:

型号 Model	M.CM.IC1000	M.CM.IC2000	M.CM.IC4000
电源 Power supply	380V/50Hz/3PH		
功率 Power	15KW	25KW	45KW
油槽规格 Size of Graphite ingot mould	1kg	2kg	1×4kg / 4×1kg
铸锭方式 Ingot casting method	真空铸锭 Vacuum ingot		
冷水机配置 Chiller Configuration	5P (19管)	5P (25管)	10P
尺寸 Size	730×622×1062mm	750×732×1062mm	1300×800×1020mm
重量 Weight	129kg	192kg	395kg

连续铸造机 Continuous casting machine

产品特点:

其经济实用与卓越的性能——为您的首选。
整机工作效率高，材质损耗低，灵活的操作方式让您最快得到您想要的铸造材型。

- 1、采用气体保护熔解，防止金属氧化，动力牵引铸造方式。
- 2、短时间内铸造高密度金、K金、银等贵金属的板条、圆条、方条、圆管及异形等规格产品。
- 3、下引法铸造，使成品内部砂孔控制在最低极限，铸造出成品完全达到深加工要求。
- 4、高效独特的搅拌式感应加热，溶解金属成色更均匀；铸型容量加大，铸造速度提升。
- 5、日本进口欧姆龙测温系统。
- 6、完善的机身安全自检系统，给您铸造优良品质提供保障。

PRODUCT FEATURES:

It's economical, practical and efficient features is your first choice.
Besides it's high efficiency, low wastage, flexible operation brings your ideal casting effect.

1. Whole melting process is protected with argon gas to prevent metal oxidation, twisting forced casting method.
2. Quick melting and casting, suitable for K gold, silver wire, tube, slice, bar and other shapes.
3. Downward casting to make high requirement, ideal casting effect.
4. Unique induction heating with auto stirring function to strengthen the power, and to make even color items, big casting capacity to improve your production efficiency.
5. Temperature detecting system from Omron Japan.
6. Various self error detect system to provide you a safe casting process.



Z.M.CM.CC005

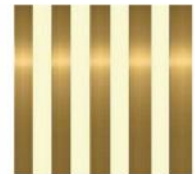

Z.M.CM.CC008

棒
Rod管
Tube片
Sheet

技术参数 TECHNICAL PARAMETERS:

型号 Model	M.CM.CC3	M.CM.CC5	M.CM.CC8
电源 Power supply	380V/50Hz/3PH		
输出功率 Power output	12KW	15KW	25KW
金属类别 Suitable metal	金 Gold、银 Silver、铜 Copper		
金属容量 Melting capacity	3kg	5kg	8kg
最大拉片尺寸 Maximum sheet size	30x8mm	30x8mm	60x10mm
最大拉棒直径 Max. rod size	Φ40mm	Φ40mm	Φ40mm
最大拉管尺寸 Max tube size	Φ30x2mm	Φ30x2mm	Φ60x2mm
适用模具 Suitable mould	根据需求定制坩埚尺寸 Size can be customized		
保护气体 Protection gas	氩气/氮气，设备输入保护气压力200KP Argon/nitrogen, equipment input protection gas pressure 200KPa		
温度范围 Temp range	标配 Standard: 0~1150°C K型 (K type) \ 选配 Option: 0~1450°C R型 (R type)		
冷却方式 Water Supply	5P水冷机 Water chiller 5P	5P水冷机 Water chiller 5P	8P水冷机 Water chiller 8P
供水 Cooling method	水冷 (纯净水) Purified water		
铸造方式 Casting type	连续铸造 Continuous casting		
异常警报 Abnormal alarm	机器自身诊断并即时停机 Self detect errors and stop working		
周边温度 Ambient temp	5°C~40°C		
湿度 Humidity	80%以下 Less than 80%		
供给源 Out source	GAS		
水温度 Water temp	10°C~20°C		
机身尺寸 Machine dimension	750×800×1650mm	750×800×1650mm	825×830×1760mm
重量 Weight	265kg	265kg	306kg

易损配件
Vulnerability Accessories



石墨上模
Graphite upper mould



石墨下模 (订制)
Graphite die (Tailored)



石英外套
Ceramic shiled



石墨棒
Graphite stirring rod



K型铠装带陶瓷插头热电偶
K type ceramic plug thermocouple

熔炼铸造
Melting and casting

进口电动剪钳
Import electric shear



T.SP.OMU16



T.SP.OMU22



T.SP.OTP50



T.SP.OTP70



T.SP.TP110

技术参数 TECHNICAL PARAMETERS:

型号 Model	T.SP.OMU16	T.SP.OMU22	T.SP.OTP50	T.SP.OTP70	T.SP.TP110
切割最大 Cut max	Φ16mm	Φ22mm R=70kg/mm ²	50x17mm	70x15mm	110x10mm
电源 Power supply	230V/50Hz 120V/60Hz(a richiesta)	230V/50Hz	230V/50Hz	230V/50Hz	230V/50Hz
瓦 Watt	1100W	1150W	1150W	1150W	1150W
转速 Rpm	10.000/min.	10.000/min.	14.000/min.	14.000/min.	14.000/min.
液压压力 Hydraulic Rower	14 ton	22 ton	30 ton	30 ton	30 ton
压力 Pressure	560 bar	700 bar	700 bar	700 bar	700 bar
尺寸 Dimensions	520x120x130mm	450x140x235mm	500x140x250mm	550x150x250mm	570x250x250mm
重量 Weight	9.1kg	13kg	22kg	27kg	40kg

贵金属甩片机 Metal-flake making Machine

将金属熔炼好后，通过高速离心甩片，制成厚度均匀的片状金属，片状厚度低于0.1mm，增加金属表面积，在提纯行业中加快提纯效率。

适用金属：金、银、铜等合金金属

主要应用行业：贵金属精炼提纯

产品特点：

- 1、成品为片状、片状厚度小于0.1mm。
- 2、甩片效率高，每小时可用60Kg，每炉5分钟，甩片约1分钟。

After finish melting, the sheet metal is made by high-speed centrifugation and rolling the sheet to make a sheet metal with a uniform thickness, with a sheet thickness below 0.1mm, increasing the metal surface area and speeding up the purification efficiency in the purification industry.

Applicable metals: gold, silver, copper and other alloys

Main applicable industry: precious metal refining and purification

FEATURES:

1. The finished product is sheet-shaped, and the thickness of the sheet is less than 0.1mm.
2. High efficiency of slice throwing, can be 60Kg per hour, 5 minutes per furnace, about 1 minute for slice throwing.



熔炼铸造
Melting and casting

技术参数 TECHNICAL PARAMETERS

型号 Model	M.CM.F10
供电 Power supply	380V 50/60Hz 3P+N+GND
功率 Power	25KW
温度范围 Temperature range	标配 Standard: 0~1150°C K型 (K type) \ 选配 Option: 0~1450°C R型 (R type)
坩埚容量 Capacity	10Kg (Fe)
制片方式 Making mode	离心甩片 Centrifugal mode
制片效率 Making speed	60Kg/小时
制片尺寸 Making sizes	片状 厚度≤0.1mm / Sheet shape, thickness≤0.1mm
保护气 Protective gas	氩气 Argon
压缩空气 Compressed air	500KPa
冷却系统 Cooling system	5P冷水机 (双进双出) / 5P chiller (double in + double out)
尺寸 Size	L1200×W1150×H1700mm
重量 Weight	400KG



P20水雾化制粉机 P20 water atomised powder making machine

1、高压水泵将高压水输送到水雾化盘的过程中，通过操控面板上的水量调节旋钮，使其控制出水量，出水量的大小直接影响到制粉颗粒的大小，进而达成可调节的出粉目数目的。

2、独特创新的机箱+出粉平台结构，设备从工作站模式改成可移动的机箱加制粉平台模式，再更换制粉产品时直接更换相同产品的出粉桶平台，无需进行清扫或担心有残留影响到其他产品。

3、为让熔炼盖达成自动开关的效果，我们在机箱内部增加辅助气缸，通过连接轴等零件与熔炼盖配合，可以很轻松的对熔炼盖进行开盖和关盖操作。

4、该设备高效的生产效率和更大的容量，更小的占地位置，独特便捷的产品更换桶及可移动平台，都大幅度提升了设备的实用性、快捷性已经生产效率。

1. In the process of high-pressure water pump convey high-pressure water to the water atomisation disc, through adjust the water volume adjustment knob on the control panel to control the amount of water, the size of the amount of water directly affects the size of the particles of the powder, and then reach an adjustable number of mesh out of the powder for the purpose.

2. Unique and innovative case + powder out platform structure, the equipment from the workstation mode into a movable case plus powder out platform mode, and when replacing the powder products can directly replace the same products out of the powder barrel platform, without the need to clean or worry about residue affecting other products.

3. In order to let the melting lid to achieve the effect of automatic opening and closing, we increase the auxiliary cylinder inside the case, through the cooperate of the connecting shaft and other parts with the melting lid, you can easily open and close the melting lid operation.

4. The equipment's efficient production efficiency and greater capacity, smaller footprint location, unique and convenient product replacement barrels and removable platforms, all greatly enhance the practicality, speed and production efficiency of the equipment.



技术参数 TECHNICAL PARAMETERS

型号 Model	M.GN.P20
供电 Power supply	AC380V, 50/60Hz, 3 phase, 90KW
温度范围 Temperature range	标配 Standard: 0~1150°C K型 (K type) \ 选配 Option: 0~1450°C R型 (R type)
坩埚熔炼 Crucible Melting	40KG金、20KG银/铜, 40KG gold、20KG silver/copper
雾化金属 Atomised metal	1400°C内的金属(金、银、铜等) Metals within 1400°C (Gold, Silver, Copper, etc.)
真空泵 Vacuum pump	内置 Built-in 100L
造粉效率 Powdering efficiency	3分钟 / 3 minutes
高压水雾化制粉 High-pressure water atomisation for powder production	50-300目可调 50-300 mesh adjustable
得粉率 Powder yield	96.70%
得粉率占比 Percentage of Powder Score	50-200目/mesh 40%, 200-250目/mesh 14.7%, 250目以上42% Above 250 mesh 42%
机身尺寸 Body size	1080×1100×1740mm

撒珠机 Granulating Machine

艺辉牌撒珠机是自主研发、生产、销售，并获得CE认证的一款畅销国内外的熔炼设备，其原理通过感应加热熔炼金属，是熔炼金、银、铜等金属材料的先进设备；由于综合使用成本低，技术成熟，被各类加工店、大中小企业广泛采购使用。

Yihui Casting brand melting furnace is independent R&D, and certified and proved by CE standards; it is one of best-selling smelter both overseas and domestic. Apply induction heating principle, it is an advanced equipment for gold, silver, copper melting. Nowadays, due to its low-cost-in-use, mature technology, it is also widely used in various shop and factories.

产品特点:

- 1、熔化时间约为3-4.5分钟，熔化效率高节电效果好，结构紧凑，过载能力强。
- 2、具有过压、过流、过热、缺水，缺相等多种保护功能。
- 3、升温迅速，省电节能，熔炼成本低。
- 4、进口双IGBT模块设计，熔化升温快，炉温容易控制，生产效率高。
- 5、多重保护设计，故障自动停机保护。
- 6、感应线圈不带电安全可靠。
- 7、100%全负载，24小时连续工作能力。

MACHINE FEATURES:

1. The melting time is about 3-4.5 minutes, high efficiency, with good power-saving effect. The structure is compact, and the overload capability is strong.
2. Overpressure, overcurrent, overheating, water shortage, phase loss, and other protection functions are all available.
3. Rapid temperature rise, energy saving, low melting costs.
4. Dual IGBT module design, melting and heating up quickly, furnace temperature is easy to control, and production efficiency is high.
5. Multiple protection design, automatic shutdown protection.
6. The induction coil is safe and reliable without electricity.
7. 100% full load, 24 hours continuous working capacity.



技术参数 TECHNICAL PARAMETERS

名称 Description	2公斤撒珠机 2kg Granulating Machine	5.5公斤撒珠机 5.5kg Granulating Machine
型号 Model	M.GN.G2000	M.GN.G5500
电源 Power Supply	380V/50Hz	380V/50Hz
功率 Power input	10kw	12kw
适用金属 Applicable metals	黄金 K金 银 铜及其合金 Pure Gold、K Gold、Silver、Copper、Alloy	
铸造方法 Casting method	重力自流式造粒 Gravity granulation	
最大容量 Maximum flux	2KG	5.5KG
温度控制 Temperature control	0-1300°C	0-1300°C
机器尺寸 Machine size	100x50x95cm	100x50x95cm
重量 Weight	98kg	97kg



50KG开放式撒珠机 50KG Open-type bead blasting machine

产品特点:

- 1、采用大功率半导体模块技术，具有较强的输出功率，稳定性高。
- 2、水泥浇筑感应线圈超低压设计，保证人身安全的同时增加隔热效果。
- 3、本机采用大功率中频感应加热方法熔炼。既可以快速加热又可对金属进行电磁搅拌，从而获得温度与成分高度均匀的金属液体。

PRODUCT FEATURES:

1. It adopts high-power semiconductor module technology, has strong output power and high stability.
2. The ultra-low voltage design of cement casting induction coil ensures personal safety while increasing the insulation effect.
3. This machine adopts high-power medium-frequency induction heating method for melting. It can heat quickly and stir the metal electromagnetically to obtain metal liquid with highly uniform temperature and composition.

技术参数 TECHNICAL PARAMETERS:

型号 Model	M.GM.50
电源 Power supply	380V / 50Hz
功率 Power	45KW
适用金属 Suitable metal	黄金 K金 银 铜及其合金 Gold, K gold, Silver, Copper and its Alloy
铸造方法 Casting method	重力自流式造粒 Gravity self-flow type granulation
最大容量 Max capacity	50KG
温度控制 Temp controller	0 - 1300°C
尺寸 Size	1016x1008x1318mm
重量 Weight	150kg

注：最大容量是指熔黄金的量，其他金属需根据不同密度计算。

Note: The maximum melting capacity refers to the amount of melted gold. Other metals need to be calculated based on different densities.



G20/G10真空造粒机
G20/G10 Vacuum Granulating Machine

产品特点:

1. 加热线圈采用低电压设计，无损加热，安全可靠。
2. 感应发生器设计用于在金属在坩埚中熔化时工作的磁场的搅拌作用下使合金均匀化。
3. 水箱中的水不断循环，通过强劲的冷水机进行冷却，以保持过程变量的控制，并获产出圆颗粒的高质量。
4. 容易从造粒桶中获得材料，并可补充冷却水。
5. 真空条件下铸造，成品无氧化，产生相同的圆颗粒，颜色稳定，球面性佳。
6. 具有完善的自我诊断系统及保护功能，确保设备故障率低。

PRODUCT FEATURES:

- 1.Heating coils adopt low voltage design.It is nondestructive heating, safe and reliable.
- 2.The induction generator is to make the metals mixed more even in the graphite crucible under the magnetic field.
- 3.The water in the water tank is continuously circulated and cooled by a powerful chiller to maintai control of the process variables and obtain the high quality of round particles.
- 4.The beads are easily obtained from the granulation bucket and can be supplemented with cooling water.
- 5.The whole casting process is under the vacuum pressure, and the metal beads are without oxidation, same size, good color formation and nice globular.
- 6.It has a complete self-diagnostic system and protection function to ensure low equipment failure rate.



G20真空造粒机
G20 Vacuum Granulating Machine



G10真空造粒机
G10 Vacuum Granulating Machine

熔炼铸造
 Melting and casting



G5真空造粒机
G5 Vacuum Granulating Machine

G5真空造粒机 G5 Vacuum Granulating Machine

产品特点:

设备造粒颗粒饱满，外表光滑，无氧化。

铸造原理:

在保护气体下进行加温熔炼，熔炼好后金属液体通过石墨模具孔滴漏到造粒桶冷却形成金属颗粒。操作流程简单易懂，整个铸造过程自动完成，一气呵成，高效省时，能让每一个操作员独立完成铸造工作。

PRODUCT FEATURES:

The granulation particles of the equipment are full and the appearance is smooth. No oxidation.

CASTING PRINCIPLE:

Conduct heating smelting under shielding gas. After smelting, the metal liquid drips to the granulation barrel through the graphite mold hole. Cool to form metal particles. The operation process is simple and easy to understand. The whole casting process is completed automatically, completed at one go, efficient and time-saving. It allows each operator to complete the casting work independently.



技术参数 Technical parameters

名称 Description	G20真空造粒机 G5 Vacuum Granulating Machine	G10真空造粒机 G5 Vacuum Granulating Machine	G5真空造粒机 G5 Vacuum Granulating Machine
型号 Model	M.GN.G20	M.GN.G10A	M.GN.G5A
电源 Power Supply	380V/50Hz/3PH	380V/50Hz/3PH	380V/50Hz/3PH
功率 Power input	45KW	25KW	15KW
控温精度 Temperature Control Precision	±1°C		
适用金属 Applicable metals	黄金 K金 银 铜及其合金 Pure Gold、K Gold、Silver、Copper、Alloy		
冷却方式 Melting cover	水冷 water cooling		
保护气 Protective gas	氩气 / 氮气 Argon / Nitrogen		
热电偶型号 Thermocouple type	标配: 0~1150°C K型 \ 选配: 0~1450°C R型 Standard: 0~1150°C K type \ Option: 0~1450°C R type		
冷水机配置 Chiller Configuration	5P	5P	3P
机器尺寸 Machine size	1000×1100×2000mm	980×990×1950mm	930×800×1760mm
重量 Weight	487kg	402kg	327kg

TMF-R无芯感应熔炼炉系列
TMF-R Coreless induction furnace series

Topcast
Engineering



熔炼铸造
Melting and casting

不同机器对应的容量和功率
POWER AND CRUCIBLE CAPACITY RELATED TO SPECIFIC METALS

型号 Model	M.MF.TMFR-10	M.MF.TMFR-15	M.MF.TMFR-25	M.MF.TMFR-35	M.MF.TMFR-45	M.MF.TMFR-60	M.MF.TMFR-100	M.MF.TMFR-150	M.MF.TMFR-200
功率 Power (kW)	10	15	25	35	45	60	100	150	200
坩埚的工作容量 Crucible working capacity (kg)									
铂金 Platinum	1	2	8	12	22	30	40	60	60
钢 Steel	2	5	10	15	25	50	100	150	200
黄铜 Brass	6	9	30	30	30	80	80	200	500
银 Silver	7	11	35	35	35	66	110	110	600
金 Gold	12	20	60	60	60	120	200	200	1200

TMF-R无芯感应熔炼炉系列：可熔铁、有色金属、宝石和和铂族金属合金，倾倒过程更精准和更安全，倾倒操作过程可采用手轮、电动或液压。

变频器的设计方法运用并联谐振技术，采用全球通用的最先进IGBT模块，线圈与电源之间的绝缘电源为用户提供最大的安全，而数字科技使熔炼炉无声，灵活和稳定地工作，光纤连接也能解决甚至在恶劣环境下的电力噪音问题。

精准的线圈保证了高温加热的效率，中频磁场搅拌，让熔炼金属更加均匀，温度调节可通过红外光学高温计和热电偶控制，而电子板通过先进的自适应调节精确算法去保证温度稳定。

一个或多个熔炼装置通过一个电源开关来带动相应的或其他的装置，以此产生感应电源，另外，我们还提供了一个主从式配制，可以临时性地使两个以两个以上的电站实现电源共享，以供选择。

机器的维修非常简单。可以方便快速度地更换坩埚及其外套。惰性气体以保护熔体不被氧化，可触摸显示屏的设置提供使用者快捷方便的使用体验，机器需要一个水冷却设备来冷却感应加热线圈和电源。

需要了解更多细节，或者更多订制方案，请联系我们！

TMF-R is a family of coreless induction melting furnaces capable of melting ferrous, non-ferrous, precious and PGM alloys. The crucible can be tilted for a more accurate and safer dosing. The driving mechanism can be by hand-wheel, electrical or hydraulic.

The frequency converter design approach uses parallel resonant typology adopting the latest and most advanced IGBTs modules available worldwide. Galvanic insulation between coil and power mains gives the maximum safety for the user, while digital technology makes our furnaces soundless, versatile and reliable. Fiber optics connections give the highest immunity to electrical noise also in harsh environment.

An accurate study of the coil guarantees a very high heating efficiency while medium frequency magnetic field stirs the molten metal and leads to high homogeneity of the alloys.

Temperature control can be chosen between IR optical pyrometer and thermocouple while the electronic board implements an advanced self-tuning thermoregulation algorithm with exact temperature stabilization.

Induction Generators can be provided with one or more melting stations using a power switch to drive one station or the other. Optionally, we offer a master-slave configuration featuring contemporary power-sharing between two or more power stations.

Maintenance of the furnace is very easy and it allows for rapid changing of the crucible and the safety refractory shell. Inert gas or gas-flame are foreseen to protect the melt from oxidation. A touch screen display is provided for a fast and user-friendly interface. A water cooling plant is needed to cool the induction heating coils and the power supply.

For more information and customized solution please contact us.

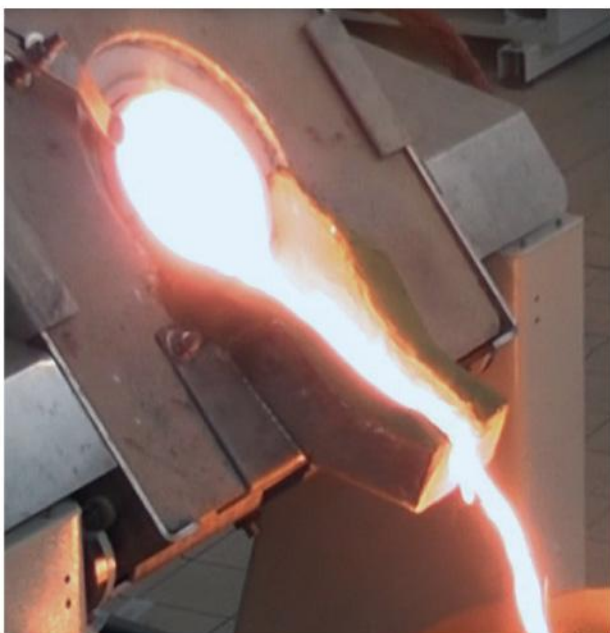
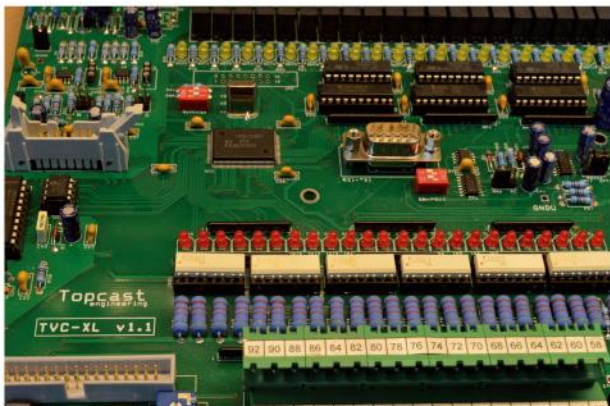

TVCd真空加压铸造机
TVCd Vacuum pressure casting machine



技术参数 TECHNICAL PARAMETERS:

型号 Model	TVC3	TVC5	TVC10-300mm	TVC12-300mm
铸造程序 Number of casting programs	100	100	100	100
坩埚容量 Crucible Volume	50 cc	100 cc	280 cc	380-500 cc
坩埚的工作能力 Crucible working capacity	200 Bronze / 250g Silver 500g Gold	400 Bronze / 500g Silver 1000g Gold	1500 Bronze / 1500g Silver 3000g Gold	2300 Bronze / 2500g Silver 5000g Gold
钢盅尺寸 Flask max. diameter (mm)	90	●150 / ○200	●150 / ○200	●150 / ○200
钢盅高度 Flask max. height (mm)	120	●300 / ○400	●300 / ○400	●300 / ○400
感应加热功率 Induction heating power	2.5 kW	4.9 kW	10 kW	12 kW
真空泵 Vacuum pump	Ext. 4 m ³ /h	Built-in 25 m ³ /h	Built-in 25 m ³ /h	Built-in 25 m ³ /h
加压压力 Pressure over vacuum	3 bar	3 bar	3 bar	3 bar
最高温度 Max. temperature	1250°C	●1250 °C / ○1600 °C	●1250 °C / ○1600 °C	●1250 °C / ○1600 °C
造粒功能 Granulation unit		○	○	○
自动设置, 数据 Autotest with data report	●	●	●	●
数据监控系统 Monitoring system for data acquisition	○	○	○	○
铸造前钢盅检查 Flask check before casting	●	●	●	●
检查漏气检查 Vacuum leakage detector	●	●	●	●
氧气分析 Oxygen Analyzer	○	○	○	○
遥控 RS232 remote interface	○	○	○	○
主要全合金 Main alloys	● Gold (Au), Silver (Ag), Copper (Cu), Brass, Bronze, Aluminium (Al) and their alloys, ○ Magnesium			

Provided (标配) ● / ○ Available on request (供选择)

TVCd是一款真空加压铸造机，专为满足失蜡铸造的高标准而设计，采用创新的双气缸理念。相比市场上传统的单气缸吸泵铸造系统，双气缸系统具有明显的优势：熔炼气缸和钢盅气缸是完全独立的，且在铸过程中使用加压功能。

相比简单的重力铸造，铸造速度更快，低温铸的效果更好，铸件的表面更光滑。

铸造只需几分钟，热传导给坩埚和熔炼的金属，即使两个周期重复也没有时间浪费。

全自动工作，并配备PC监控系统，用于搜集处理数据及生产数据管理，操作简单，对大多数合金（可选）都适用。



TVCd is the pressure over vacuum casting machine designed to meet the more severe needs in lost wax casting production.

This machine works with a new, revolutionary double chamber concept. This innovative system gives several advantages compared with the traditional single chamber suction system currently available in the market. In TVCd melting chamber and flask chamber are completely independent and at the moment of casting the machine controls the metal injection into the mold by applying a differential pressure during pouring.

This yields to a faster injection compared to the simply gravity pouring with the benefit to cast items at lower temperature. This will result in better surface finishing of the cast parts.

The casting cycle takes only few minutes and, while the previous charge can be loaded into the crucible and melted, thus overlapping two cycles for no time waste.

The machine is fully automatic having also a PC based monitoring system for process parameters acquisition and production data management with easy editing of casting programs suitable for many kind of alloy (optional).

技术和特点 TECHNOLOGY & FEATURES

气体清洗过程

- 加料进坩埚会有氧气进入。
- GWS 程序会高效地除氧 (1)，并重新加入氩气和氮气 (2)。
- 比起传统的通过流量计控制保持气体，这款机器能显著地减少气体消耗，而且合金的氧化降到最低。
- 坩埚的寿命长：250-400次。

熔炼

- 先进的AST™温控器，更精准的控制合金温度。
- 两种温度设定：均化温度和铸造温度。
- 中频感应加热带搅拌功能，达到完美均化效果。
- PSM™ 适用于超低频率搅拌。
- 最高功率密度特性，搅拌力度大，金损耗小。

铸造和加压

- 当塞棒抬起，特别要注意铸造速度避免金属移动。
- TVC 具有独特的功能，铸造速度可以调整，编程。
- 金属平滑的注入石膏模 (4)。然后填充，在固化过程中，强有力的加压能金属流到树的每个部位。
- 在加料和加压条件下金属不会移动，有效地减少缩水和气孔现象。

铸造后树的保护

- 由于双气缸的优势，金属固化后，钢盅是在一个保护环境下冷却的，同是你可以向熔炼框加料，开始第二轮熔炼。
- 这个操作允许两个步骤一起进行，树可以在钢盅框长时间保护，提高铸效果，同时也没有浪费时间提高生产力。



GAS WASH PROCEDURE

- Crucible loading operation introduces oxygen.
- The Gas Wash Purge procedure removes the oxygen (1) in a very fast and efficient way and then refills back the chambers with Argon or Helium gas (2).
- Compared with the traditional crucible protection with flow-meter regulation the consumption of gas is dramatically reduced and the alloys oxidation is minimized.
- Moreover the crucible life is increased: TVC series crucible last up to 250 - 400 casting cycles according to the graphite quality.

MELTING

- Advanced Self Tuning thermoregulation (AST™) with exact temperature control of the melted alloys.
- Two Set-Points available: Homogenization and Casting Temperature.
- Medium frequency induction heating stirs the melted alloy and leads to a perfect homogeneity
- Pulse Stirring Management (PSM™) for an extremely low frequency stirring.
- Highest power density in the market features strongest stirring and low gold losses.

INJECTION AND COMPRESSION

- When the stopper lifts up, it is very important to control the injection rate to avoid turbulences.
- TVC has the unique feature to have the injection rate controllable and programmable (IRC™).
- The metal enters smoothly inside the mould (4). Then, after filling and during the solidification phase, a strong compression takes place on the tree (5).
- No turbulences in filling and high compression rate lead to a large reduction of shrinkage porosity phenomena.

TREE PROTECTION AFTER CASTING

- Thanks to the double chamber concept, after the solidification phase, the flask cools down in a protective atmosphere while at the same time you can load your alloy in the melting chamber for the next melting.
- This operation will allows an overlapping of the casting cycles which will give you the ability to protect longer the tree before removing it without losing time and productivity.

■ Air ■ Vacuum ■ Gas

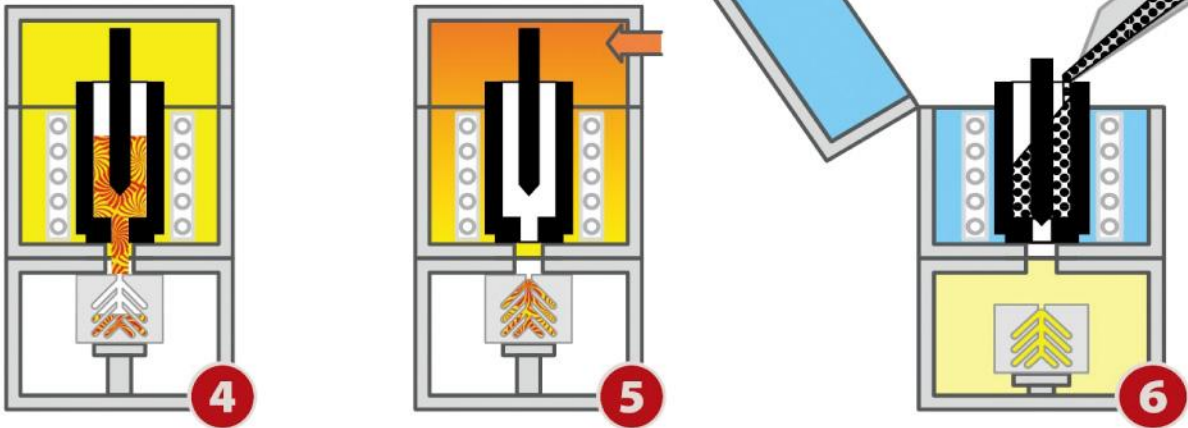
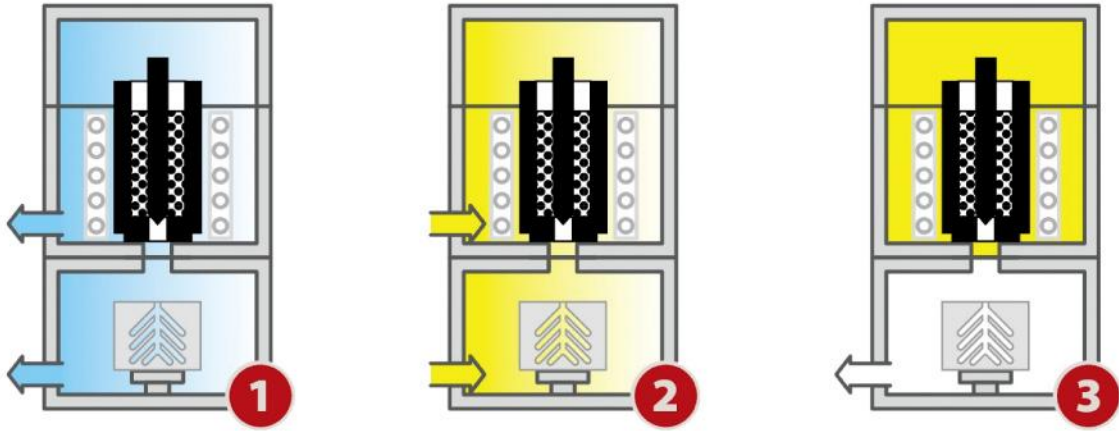

熔炼铸造
Melting and casting



YELLOW GOLD | ORO GIALLO
21/22 KT



Casting | Microfusione

22KT	EK214S
21/22 KT	RM83
21/22 KT	EK95M
21 KT	M46X3
21 KT	M40X10
21 KT	M29X3
21 KT	M23I9
21 KT	EK214S
21 KT	R94S
21/22 KT	CU22

Mechanical | Meccanica

21/22 KT	EK212A
21/22 KT	EK213A
21/22 KT	G82X
21 KT	EK21
21 KT	EK42

All Purpose | Universale

21 KT	EK183X
21 KT	P40X2
21 KT	R29X3
21 KT	EK143X
21 KT	R15X5
21 KT	R16I2
21 KT	R5X10
21 KT	R5X5
21/22 KT	RED5XD
21/22 KT	RED5X
22KT	CU22
21/22 KT	RED1
21/22 KT	R94
21 KT	G81X

YELLOW GOLD | ORO GIALLO
18 KT

Casting | Microfusione

M57X3	M29X3
M50X10	M23I9
M54X55	M20X16
EK183S	EK95M
M46X3	GM96X
M40X10	GM90X
M40X2	GM80
EK18AM	GM75X

Mechanical | Meccanica

P55X4	P35I10
EK18AV	P32C8
EK184A	EK143X
EK181AV	P20X15
EK182X	EK21

Mechanical | Meccanica

EK43	EK51
EK31	G82X
G90X	EK80
EK42	EK41
EK71	EKT62

All Purpose | Universale

EK141X	EK141A
P48X13	RED1
P48X11	EK95
EK181A	EKT2
EK183X	EK93
EK18A	G83X
P47I3	G92X
P46I7	R94
EK18X	G86X
P45X2	B61
P40X5	G81X
P40X2	F113
P30X25	G75X
R29X3	G80X

YELLOW GOLD | ORO GIALLO
14 KT

Casting | Microfusione

M40X10	M10X12
M40X2	RM11X9
M29X3	M10X17
M25X20	M5X20
M23I9	M5X27
M20X16	EK101
M18X17	GM90X
M18X10	GM80
M15X15	GM75X
M15X16	

Mechanical | Meccanica

R29X3	P20X18
EK14AV	EK31
P25X15	EK71
EK893AV	EK51
EK89AV	EK41
EKGV814	EK75
EKG814	

All Purpose | Universale

P48X11	P40X10
P45X2	EK182X

EK141A	P4X12
EK14A	EKT62
P23X11	G90X
P20X15	G75X
EK89A	G81X
EKG15	F113
P12X14	F4
P10X20	G80X
P5X23	G80IR
P5X26	S.GIALLA

YELLOW GOLD | ORO GIALLO
9 KT

Casting | Microfusione

M23I9	M10X17
M20X16	M5X20
M18X10	EK101
M18X17	GM90X
M15X16	GM80
M15X15	GM75X

Mechanical | Meccanica

EK14AV	G80IR
EK893AV	EK71
EK89AV	EK51
EKGV814	EK41
EKG15	EK75
EKG814	EK31

All Purpose | Universale

EK141A	P5X26
EK14A	B61
P23X11	G90X
P20X18	G80X
P20X15	F113
EK89A	F4
P12X14	G75X
P10X20	S.GIALLA
P5X23	

RED GOLD | ORO ROSSO
21 KT



Casting | Microfusione

RM2	RM15G2
RM5	RM13X5
RRM	CU22
RM83	

ekisson

All Purpose | Universale

R13X3	RED5X
RED1	R2X2
R5C1	R4X2
RED5XD	EK21

RED GOLD | ORO ROSSO
18 KT

Casting | Microfusione

RRM	EKRMX
RM2	RM10
RM8G2	RM15G2
RM5	RM83

Mechanical | Meccanica

EKR1	R16I2
EKRR	EKR800
R5C1	EK21
RED5XD	

All Purpose | Universale

R2X2	R15X5
RED5X	R17X2
R4X2	RRC
R6X2	R83
R5X5	RED1
R10X3	G83X
R15X3	EK95
R13X3	EKR3
R18X5	EKR14

RED GOLD | ORO ROSSO
14 KT

Casting | Microfusione

RRM	RM15G2
RM2	RM17X2
RM5	RM13X5
EKRMX	RM83
RM8G2	R94S
RM10	

Mechanical | Meccanica

EKR1	EKR800
EKRR	EK21
R16I2	

Casting | Microfusione

RM2	RM15G2
RM5	RM13X5
RRM	CU22
RM83	

All Purpose | Universale

R2X2	RED5X
------	-------

R5C1	RRC
R6X2	R83
R5X5	RED1
R10X3	G83X
R13X3	EK95
R15X3	S.ROSSA
R18X5	EKR14
R15X5	EKR3

RED GOLD | ORO ROSSO 9 KT

Casting | Microfusione

RRM	RM15G2
RM2	RM17X2
RM5	RM13X5
EKRMX	RM83
RM8G2	R94S
RM10	

Mechanical | Meccanica

EKR1	R16I2
EKRR	EKR800

All Purpose | Universale

R2X2	R15X5
RED5X	EKR14
R5C1	RRC
R6X2	R83
R5X5	RED1
R10X3	G83X
R15X3	EK95
R13X3	ROSSA
R18X5	EKR3

WHITE GOLD | ORO BIANCO 21 KT

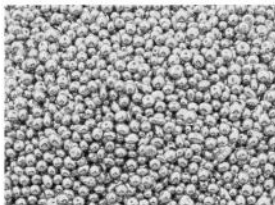

Casting | Microfusione

BM40C18	EKB23MX
EKB90MX	EKBM
BM26X14	BM18A15

All Purpose | Universale

EKB90AX	EKB24
B30C15	EKB1A
B26A5	BA18A20
BIANCA EXTRA	

WHITE GOLD | ORO BIANCO 18 KT

Casting | Microfusione

EKB90MX	BM18A15
BM26X14	BM15A3
EKB23MX	EKB15M
BM21A3	EKB12MX
EKBM	BM12A5
BM20A7	

All Purpose | Universale

EKB90AX	EKB2
B30C15	SOVRAN
BNP28	BIANCA
BIANCA	B16A5
EXTRA	EKB800
B26A5	B15A10
EKB24	EKB14X
EKB1A	EKB12
B20A2	EKBA89
BA18A20	EKB89
B20X18	

WHITE GOLD | ORO BIANCO 14 KT

Casting | Microfusione

BM26X14	BM15A3
EKB23MX	EKB15M
BM21A3	EKB12MX
EKBM	BM12A5
BM20A7	BM8A20
BM18A15	

All Purpose | Universale

BIANCA	B16A5
EXTRA	EKB800
B26A5	B15A10
EKB24	EKB14X
EKB1A	EKB12
B20A2	EKBA89
B20X18	EKBDT
EKB2	EKB89
BA18A20	B5A26
SOVRAN	B5A8
BIANCA	

WHITE GOLD | ORO BIANCO 9 KT

Casting | Microfusione

BM18A15	BM12A5
EKB15M	BM8A20
EKB12MX	BA18A20

B16A5	EKBDT
B15A10	EKB89
EKB14X	B5A26
EKB12	B5A8
EKBA89	

WHITE GOLD NICHEL FREE

18 KT	EKBP53
18/14 KT	EKP31M
18 KT	EKP26
14 KT	EKP15
14 KT	EKBP
14/9 KT	B65
14/9 KT	BAG

SILVER | ARGENTO 925



Casting | Microfusione

T90	EKTMS
EK95M	EKTSS
EKT15S	GM75
EKT14S	AGM64
EKT30S	TM45

Mechanical | Meccanica

EKT21	F113
EKT51	EKASC
EKT1	EKT31

All Purpose | Universale

TR5	L285
EKTF	EKTM
TR94	EKT2
TOP-AG	EKT14
EKT93	EKT62
L280	CU22

SOLDERING | SALDATURE 22 KT



EKFAS23	EKFAS22
---------	---------

SOLDERING | SALDATURE 21 KT

EKFAS23	EKFAS21
EKFAS22	

SOLDERING | SALDATURE 18 KT

EKFAS21	FAS10
EKFAS20	FAS7
EKFAS30	FAS8
EKFAS18	EKFASRS
EKFAS17	EKFASRR
EKFAS15	EKFASR
EKFAS14	EKFASB
FAS375	EKFASB89

SOLDERING | SALDATURE 14 KT

EKFAS18	EKFASRS
EKFAS15	EKFASRR
EKFAS14	EKFASR
FAS375	EKFASB
EKFAS89	EKFASB89
FAS8	

SOLDERING | SALDATURE 9 KT

FAS375	EKFASRR
EKFAS89	EKFASB89
FAS9	FASBNF
EKFASRS	

SOLDERING | SALDATURE Ag

FAS7	FAS4
FAS6	FAS3
FAS2	

POWDER SOLDERING AND METALS | SALDATURE EMETALLI IN POLVERE

SP1	830°C - 910°C
SP3	830°C - 890°C
SPAG	830°C - 910°C
SPOT	830°C - 910°C
ZNP	830°C - 910°C
CUP	830°C - 910°C



工业智能冷水机 Industrial intelligence water cooling machines

COLDSOAR by Yihu! Casting®

使用范围

- 1、工业上广泛用于塑胶加工机械成型模具冷却、电子、化工、冶金、食品、制药、电镀、皮革、工艺和科研等；
- 2、商业上广泛用于酒店、宾馆、超级市场和影剧院等。

产品特点

- 1、**操作简便**：冷水机里简洁明了的控制面板，在内部配置部件的安装下，维修和保养都是十分方便简单的。
- 2、**款式齐全**：冷水机里整机运行功率和运行温度都有常温冷水机，低温冷水机，超低温冷水机三种款式，对各个行业单机控温专配非常方便。
- 3、**使用寿命长**：蒸发器，冷凝器设计非常合理，并且置于压缩机上方，在整个运行过程中，绝大部分润滑油始终停留在压缩机内，能有效保证压缩机的好润滑。
- 4、**运转稳定**：采用世界名牌全密闭型压缩机，不仅效率高，噪音低，振动小等优势，而且配置多重保护装置，可以有效的节省能量，并可根客户求采用环保冷媒压缩机。
- 5、**电子电路进行能量自动调节**：首先是有效降低电网启动负荷，其次是当用户使用负荷低于总负荷一定量时机组便自动减少运行机数，同时将冷却水截止，最后有效节约电能，在一定程度上可以取代其它低频冷水机。
- 6、**制冷强劲**：适应性特强，水冷式冷凝器，蒸发器采用进口优质料做热交换面，并结合多项专利技术精制而成，从而使冷凝器能充足液化，蒸发器能充足气化，节约冷却电能，增强冷冻能力，即使本系列机在较恶劣情况下也能正常工作。
- 7、**节水省电**：随着冷水机成为制冷行业的选购前卫，节能便会成为客户群体畅聊的话题；由此，我公司为更好的创新节能能源，特在设计生产时改进之前的节能方案；便利用优质冷凝器，蒸发器，添加多回路设计，而两个以上压缩机均采用一个压缩机自带一个回路，电子温控调节，设置节能水箱。

USE RANGE

1. In industry, it is widely used in plastic processing machinery molding mold cooling, electronics, chemical industry, metallurgy, food, pharmaceutical, electroplating, technology and scientific research, etc.
2. Commercially, it is widely used in hotels, guesthouses, supermarkets and theaters.

PRODUCT FEATURE

1. **Easy to operate**: the simple and clear control panel in the chiller, under the installation of internal configuration components, repair and maintenance are very convenient and simple.
2. **Complete styles**: there are three types of chiller: normal temperature chiller, low temperature chiller and ultra-low temperature chiller. It is very convenient for single machine temperature control in various industries.
3. **Long service life**: evaporator and condenser design is very reasonable, and placed above the compressor, in the whole operation process, the vast majority of lubrication is always stopped and will stay in the compressor, which can effectively ensure the good lubrication of the compressor.
4. **Stable operation**: it adopts the world famous brand hermetic compressor, which not only has the advantages of high efficiency, low noise and small vibration, but also has multiple protection devices, which can effectively save energy, and can adopt environmental protection refrigerant compressor according to customer requirements.
5. **Electronic circuit for energy automatic regulation**: "the first is to effectively reduce the grid start-up load, the second is when the user's load is lower than the total load by a certain amount, the unit will automatically reduce the number of operating units, at the same time, the cooling water will be cut off, and finally effectively save electric energy, which can replace other low-frequency chillers to a certain extent.
6. **Strong refrigeration**: strong adaptability. Water cooled condenser, evaporator using high-quality material as heat exchange surface, and combined with a number of patent technology refined, so that the condenser can be fully liquefied, evaporator can give up enough gasification, save cooling power, enhance the refrigeration capacity, even if this series of machines can work normally under bad conditions.
7. **Water saving and power saving**: with the chiller becoming the vanguard of the refrigeration industry, energy saving will become a topic of conversation among customers. Therefore, in order to better innovate and save energy, our company improves the previous energy-saving scheme in the design and production. It is convenient to use high-quality condenser and evaporator, and add multi-loop design. More than two compressors adopt one compressor with one circuit, electronic temperature Control regulation, set up energy saving water tank.



CLW-1000



技术参数 TECHNICAL PARAMETERS

型号 Model	CLW-1000AI	CLW-1000BI	CLW-1000DI	CLW-1000AN	CLW-1000BN	CLW-1000DN
工作电压 Work voltage	AC 1P 220V	AC 1P 220V	AC 1P 110V	AC 1P 220V	AC 1P 220V	AC 1P 110V
工作频率 Work frequency	50Hz	60Hz	60Hz	50Hz	60Hz	60Hz
整机额定功率 Rated power	1.1KW	1.1KW	1.1KW	1.35KW	1.35KW	1.35KW
水泵功率 Water pump power	88W	88W	88W	370W	370W	370W
最大扬程 Maximum head	25M	25M	25M	29M	29M	29M
额定流量 Rated flow	25L/min	25L/min	25L/min	33L/min	33L/min	33L/min
名义制冷量 Cooling capacity	3KW	3KW	3KW	3KW	3KW	3KW
压缩机类型 Compressor type	旋转式 Vortex	旋转式 Vortex	旋转式 Vortex	旋转式 Vortex	旋转式 Vortex	旋转式 Vortex
温控精度 Temperature control accuracy	±0.5°C	±0.5°C	±0.5°C	±0.5°C	±0.5°C	±0.5°C
制冷剂 Refrigerant	R-410a	R-410a	R-410a	R-410a	R-410a	R-410a
节流器 Restrictor	毛细管 Capillary tube					
水箱容量 Water tank capacity	19L	19L	19L	19L	19L	19L
蒸发器类型 Evaporator type	水箱盘管式 Water tank coil type					
出入口水口 Water outlet/inlet	Rp1/2"	Rp1/2"	Rp1/2"	Rp1/2"	Rp1/2"	Rp1/2"
重量 Weight	60kg	60kg	60kg	60kg	60kg	60kg
尺寸 Size	49×66×88cm	49×66×88cm	49×66×88cm	49×66×88cm	49×66×88cm	49×66×88cm

CLW-1500



熔炼铸造
Melting and casting

技术参数 TECHNICAL PARAMETERS

型号 Model	CLW-1500AI	CLW-1500BI	CLW-1500DI	CLW-1500AN	CLW-1500BN	CLW-1500DN
工作电压 Work voltage	AC 1P 220V	AC 1P 220V	AC 1P 110V	AC 1P 220V	AC 1P 220V	AC 1P 110V
工作频率 Work frequency	50Hz	60Hz	60Hz	50Hz	60Hz	60Hz
整机额定功率 Rated power	1.75KW	1.75KW	1.75KW	1.9KW	1.9KW	1.9KW
水泵功率 Water pump power	370W	370W	370W	370W	370W	370W
最大扬程 Maximum head	29M	29M	29M	29M	29M	29M
额定流量 Rated flow	33L/min	33L/min	33L/min	33L/min	33L/min	33L/min
名义制冷量 Cooling capacity	4.1KW	4.1KW	4.1KW	4.1KW	4.1KW	4.1KW
压缩机类型 Compressor type	旋转式 Vortex	旋转式 Vortex	旋转式 Vortex	旋转式 Vortex	旋转式 Vortex	旋转式 Vortex
温控精度 Temperature control accuracy	±0.5°C	±0.5°C	±0.5°C	±0.5°C	±0.5°C	±0.5°C
制冷剂 Refrigerant	R-410a	R-410a	R-410a	R-410a	R-410a	R-410a
节流器 Restrictor	毛细管 Capillary tube					
水箱容量 Water tank capacity	19L	19L	19L	19L	19L	19L
蒸发器类型 Evaporator type	水箱盘管式 Water tank coil type					
出入口 Water outlet/inlet	Rp1/2"	Rp1/2"	Rp1/2"	Rp1/2"	Rp1/2"	Rp1/2"
重量 Weight	66kg	66kg	66kg	66kg	66kg	66kg
尺寸 Size	49×66×88cm	49×66×88cm	49×66×88cm	49×66×88cm	49×66×88cm	49×66×88cm

CLW-2000



技术参数 TECHNICAL PARAMETERS

型号 Model	CLW-2000AI	CLW-2000BI	CLW-2000AB	CLW-2000BN
工作电压 Work voltage	AC 1P 220V	AC 1P 220V	AC 1P 220V	AC 1P 220V
工作频率 Work frequency	50Hz	60Hz	50Hz	60Hz
整机额定功率 Rated power	2.2KW	2.2KW	2.4KW	2.4KW
水泵功率 Water pump power	370W	370W	370W	370W
最大扬程 Maximum head	29M	29M	29M	29M
额定流量 Rated flow	33L/min	33L/min	33L/min	33L/min
名义制冷量 Cooling capacity	5.5KW	5.5KW	5.5KW	5.5KW
压缩机类型 Compressor type	旋转式 Vortex	旋转式 Vortex	旋转式 Vortex	旋转式 Vortex
温控精度 Temperature control accuracy	±0.5°C	±0.5°C	±0.5°C	±0.5°C
制冷剂 Refrigerant	R-410a	R-410a	R-410a	R-410a
节流器 Restrictor	毛细管 Capillary tube	毛细管 Capillary tube	毛细管 Capillary tube	毛细管 Capillary tube
水箱容量 Water tank capacity	19L	19L	19L	19L
蒸发器类型 Evaporator type	水箱盘管式 Water tank coil type	水箱盘管式 Water tank coil type	水箱盘管式 Water tank coil type	水箱盘管式 Water tank coil type
出入口 Water outlet/inlet	Rp1/2"	Rp1/2"	Rp1/2"	Rp1/2"
重量 Weight	75kg	75kg	75kg	75kg
尺寸 Size	49×66×88cm	49×66×88cm	49×66×88cm	49×66×88cm

CLW-3000



熔炼铸造
Melting and casting

技术参数 TECHNICAL PARAMETERS

型号 Model	CLW-3000AN	CLW-3000BN	CLW-3000EN
工作电压 Work voltage	AC 1P 220V	AC 1P 220V	AC 3P 380V
工作频率 Work frequency	50Hz	60Hz	50Hz
整机额定功率 Rated power	3.2KW	3.2KW	3.4KW
水泵功率 Water pump power	370W	370W	550W
最大扬程 Maximum head	29M	29M	48M
额定流量 Rated flow	33L/min	33L/min	33L/min
名义制冷量 Cooling capacity	8.2KW	8.2KW	8.5KW
压缩机类型 Compressor type	旋转式 Vortex	旋转式 Vortex	旋转式 Vortex
温控精度 Temperature control accuracy	±1°C	±1°C	±1°C
制冷剂 Refrigerant	R-410a	R-410a	R-410a
节流器 Restrictor	毛细管 Capillary tube	毛细管 Capillary tube	毛细管 Capillary tube
水箱容量 Water tank capacity	45L	45L	45L
蒸发器类型 Evaporator type	水箱盘管式 Water tank coil type	水箱盘管式 Water tank coil type	水箱盘管式 Water tank coil type
出入口 Water outlet/inlet	Rp3/4"	Rp3/4"	Rp3/4"
重量 Weight	120kg	120kg	120kg
尺寸 Size	56×78×97cm	56×78×97cm	56×78×97cm

CLW-5000



技术参数 TECHNICAL PARAMETERS

型号 Model	CLW-5000EN	CLW-5000FN
工作电压 Work voltage	AC 3P 380V	AC 3P 380V
工作频率 Work frequency	50Hz	60Hz
整机额定功率 Rated power	5.5KW	5.5KW
水泵功率 Water pump power	750W	750W
最大扬程 Maximum head	48M	48M
额定流量 Rated flow	66L/min	66L/min
名义制冷量 Cooling capacity	15.2KW	15.2KW
压缩机类型 Compressor type	旋转式 Vortex	旋转式 Vortex
温控精度 Temperature control accuracy	±1°C	±1°C
制冷剂 Refrigerant	R-410a	R-410a
节流器 Restrictor	热力膨胀阀 Thermostatic expansion valve	热力膨胀阀 Thermostatic expansion valve
水箱容量 Water tank capacity	70L	70L
蒸发器类型 Evaporator type	水箱盘管式 Water tank coil type	水箱盘管式 Water tank coil type
出入口 Water outlet/inlet	Rp3/4"	Rp3/4"
重量 Weight	175kg	175kg
尺寸 Size	65×85×129cm	65×85×129cm

CLW-8000/10000



熔炼铸造
Melting and casting

技术参数 TECHNICAL PARAMETERS

型号 Model	CLW-8000EN	CLW-8000FN	CLW-10000EN	CLW-10000FN
工作电压 Work voltage	AC 3P 380V	AC 3P 380V	AC 3P 380V	AC 3P 380V
工作频率 Work frequency	50Hz	60Hz	50Hz	60Hz
整机额定功率 Rated power	8.6KW		10.6KW	
水泵功率 Water pump power	750W		1000W	
最大扬程 Maximum head	48M		61M	
额定流量 Rated flow	66L/min		66L/min	
名义制冷量 Cooling capacity	23KW		29.2KW	
压缩机类型 Compressor type	涡旋式 Vortex		涡旋式 Vortex	
温控精度 Temperature control accuracy	±1°C		±1°C	
制冷剂 Refrigerant	R-410a		R-410a	
节流器 Restrictor	热力膨胀阀 Thermostatic expansion valve		热力膨胀阀 Thermostatic expansion valve	
水箱容量 Water tank capacity	130L		150L	
蒸发器类型 Evaporator type	水箱盘管式 Water tank coil type		水箱盘管式 Water tank coil type	
出入口 Water outlet/inlet	Rp1"		Rp1"	
重量 Weight	250kg		265kg	
尺寸 Size	80×139×146cm		80×139×146cm	



石墨系列 Graphite series

石墨材料采用特种高纯、高强、高密度的石墨材料；优秀的技术人员；高精度的数控加工设备等，可以给客户提供性能优良的石墨熔炼坩埚、铸造坩埚、石墨油槽、拉管、拉片、拉棒的模具、规格繁多、未能尽列、欢迎来图来样定制石墨产品。

所选特种专用材料，可以让我们的石墨坩埚产品比普通材料产品耐用程度2倍以上，使用寿命更长，更加可以承受超过2000°C的高温！

同时更拥有以下特点：

- 1、良好的热稳定性：针对石墨坩埚急热急冷的使用条件，特别配方。
- 2、良好的耐腐蚀、耐冲击性能、以保证产品质量的可靠性。
- 3、良好的耐强酸、强碱。
- 4、良好的热传导性能：可以极大缩短熔炼时间，节约能源。
- 5、小于300pp的灰分，确保贵金属在冶炼中不被污染。

Apply high purity, high strength, high density graphite materials, equipped with excellent experts and high precision CNC equipment to supply clients with high quality graphite melting crucible, graphite casting crucible, graphite ingot mould, graphite mould for tube, slice, wire, too many various sizes to be listed out, you are welcome to Yihuicasting who make products as per your requirement.

Selected special materials, durability of Yihui graphite products doubles common material made, long working life and anti more than 2000°C high temp.

MAIN FEATURES:

1. Good thermal stability, considering sudden heat and cold working condition, we apply special raw materials
2. Good ability to anti corrosion, impact to ensure reliability of product quality.
3. Anti strong acid, anti strong alkali. Impact resistance: graphite crucible can withstand strong heat impact, therefore you can use it for any workmanship process.
4. Good thermal conductivity: due to its high thermal conductivity, you can shorten melting time, saving energy.
5. Ash content is less than 300pp, melting metal can not be polluted during melting process.

石墨熔炼坩埚 (可订制) Induction crucible set (tailored)

石墨熔炼坩埚套件 Induction crucible set

名称 Description	型号 Model	尺寸 Size (mm)				重量 Weight
		Φ1	Φ2	Φ3	H	
1公斤石墨熔炼坩埚 1 kg graphite melting crucible	G.GM.1000A	58	35	47	88	160g
1.25公斤石墨熔炼坩埚 1.25 kg graphite melting crucible	G.GM.1250A	72	48	60	88	/
2公斤石墨熔炼坩埚 2 kg graphite melting crucible	G.GM.2000A	65	44	57	110	240g
2公斤圆底石墨熔炼坩埚 2 kg graphite melting crucible with round bottom	G.GM.2000Y	65	44	57	110	270
2公斤无边石墨熔炼坩埚 2 kg graphite melting crucible without collar	G.GM.2000W	58	42	58	110	260
2.5公斤石墨熔炼坩埚 2.5 kg graphite melting crucible	G.GM.2500A	65	44	57	126	280g
2.5公斤石墨熔炼坩埚 2.5 kg graphite melting crucible	G.GM.2500F	65	40	54	126	/
3公斤石墨熔炼坩埚 3 kg graphite melting crucible	G.GM.3000A	85	60	75	105	390g
4公斤石墨熔炼坩埚 4 kg graphite melting crucible	G.GM.4000A	85	60	76	131	470g
4公斤石墨熔炼坩埚 4 kg graphite melting crucible	G.GM.4000B	85	60	76	137	470g
4公斤石墨熔炼坩埚 4 kg graphite melting crucible	G.GM.4000F	85	58	72	131	/
4.5公斤石墨熔炼坩埚 4.5 kg graphite melting crucible	G.GM.4500A	98	65	81	135	/
5公斤石墨熔炼坩埚 5 kg graphite melting crucible	G.GM.5000A	100	69	88	131	640g
5公斤无边石墨熔炼坩埚 5 kg graphite melting crucible without collar	G.GM.5000W	88	69	88	135	/
5.5公斤石墨熔炼坩埚 5.5 kg graphite melting crucible	G.GM.5500A	105	70	90	156	850g
5.5公斤石墨熔炼坩埚 5.5 kg graphite melting crucible	G.GM.5500F	105	70	89	156	/
5.5公斤无边石墨熔炼坩埚 5.5 kg graphite melting crucible without collar	G.GM.5500W	90	70	90	155	/
6公斤石墨熔炼坩埚 6 kg graphite melting crucible	G.GM.6000A	115	79	97	178	1000g
6公斤石墨熔炼坩埚 6 kg graphite melting crucible	G.GM.6000B	115	79	100	180	1190g
6公斤石墨熔炼坩埚 6 kg graphite melting crucible	G.GM.6000F	115	79	98	180	/
6公斤无边石墨熔炼坩埚 6 kg graphite melting crucible without collar	G.GM.6000W	97	77	97	167	1600g
8公斤石墨熔炼坩埚 8 kg graphite melting crucible	G.GM.8000A	115	84	105	177	1870g
8公斤石墨熔炼坩埚 8 kg graphite melting crucible	G.GM.8000B	120	84	110	181	1900g
12公斤石墨熔炼坩埚 12 kg graphite melting crucible	G.GM.12000	150	96	126	210	/
16公斤石墨熔炼坩埚 16 kg graphite melting crucible	G.GM.16000	160	110	138	220	/
20公斤石墨熔炼坩埚 20 kg graphite melting crucible	G.GM.20000	186	124	160	248	/
30公斤石墨熔炼坩埚 30 kg graphite melting crucible	G.GM.30000	210	150	210	250	/
40公斤石墨熔炼坩埚 40 kg graphite melting crucible	G.GM.40000	198	136	235	255	/

石墨石英
Graphite and ceramic





Kerr石墨熔炼坩埚 Graphite melting crucible

名称 Description	型号 Model	尺寸 Size (mm)				重量 Weight	机器 Machine
		Φ1	Φ2	Φ3	H		
Kerr1公斤石墨熔炼坩埚 Kerr 1 kg graphite melting crucible	G.GM.KE1000	57	34	43	125.9	190 g	Kerr-1000
Kerr3公斤石墨熔炼坩埚 Kerr 3 kg graphite melting crucible	G.GM.KE3000	102	62.8	85	126	840 g	Kerr-3000



双环石墨熔炼坩埚 Graphite melting crucible with neck

名称 Description	型号 Model	尺寸 Size (mm)				重量 Weight	机器 Machine
		Φ1	Φ2	Φ3	H		
1公斤双环石墨熔炼坩埚 1 kg graphite melting crucible	G.GM.1000SH	65	38	50	125	245 g	1kg 手提炉/ Melting furnace
2公斤双环石墨熔炼坩埚 2 kg graphite melting crucible	G.GM.2000SH	72	44	55	155	330 g	2kg 手提炉/ Melting furnace
3公斤双环石墨熔炼坩埚 3kg graphite melting crucible	G.GM.3000SH	75	50	60	170	390 g	3kg 手提炉/ Melting furnace

Graphite and ceramic



石墨粘土坩埚 Clay-graphite crucibles

型号 Model	尺寸 Size (mm)			重量 Weight	型号 Model	尺寸 Size (mm)			重量 Weight
	Φ1	Φ2	H			Φ1	Φ2	H	
G.GN.00005W	120	85	150	1kg	G.GN.00100W	330	250	420	20kg
G.GN.00005W-b	120	80	140	1kg	G.GN.00120W	340	250	430	24kg
G.GN.00010W	150	100	180	2kg	G.GN.00150W	360	290	440	30kg
G.GN.00010W-b	130	90	160	2kg	G.GN.00200W	395	300	490	40kg
G.GN.00016W	165	110	215	3.2kg	G.GN.00250W	440	350	560	50kg
G.GN.00020W	185	130	230	4kg	G.GN.00300W	460	350	630	60kg
G.GN.00030W	210	155	250	6kg	G.GN.00350W	500	380	710	70kg
G.GN.00040W	240	185	295	8kg	G.GN.00500W	550	425	780	100kg
G.GN.00050W	260	190	300	10kg	G.GN.00800W	700	550	680	130kg
G.GN.00060W	270	200	335	12kg	G.GN.01000W	710	550	800	150kg
G.GN.00080W	295	230	390	16kg	G.GN.02000W	800	710	800	180kg

石墨粘土坩埚 Clay-graphite crucibles



型号 Model	尺寸 Size (mm)				重量 Weight
	Φ1	Φ2	Φ3	H	
G.GN.A0001W	70	50	9	80	0.2kg
G.GN.A0002W	87	65	9	107	0.4kg
G.GN.A0003W	105	72	10	120	0.6kg
G.GN.A0005W	118	75	11	145	1kg
G.GN.A0008W	127	85	13	168	1.6kg
G.GN.A0010W	137	91	14	180	2kg
G.GN.A0012W	150	102	14	195	2.4kg
G.GN.A0016W	160	102	17	205	3.2kg
G.GN.A0020W	178	120	18	225	4kg
G.GN.A0030W	215	146	19	260	6kg
G.GN.A0040W	230	165	19	285	8kg
G.GN.A0050W	257	149	21	314	10kg
G.GN.A0060W	270	186	23	327	12kg
G.GN.A0070W	280	190	25	360	14kg

型号 Model	尺寸 Size (mm)				重量 Weight
	Φ1	Φ2	Φ3	H	
G.GN.A0080W	296	189	26	356	16kg
G.GN.A0100W	321	213	29	379	20kg
G.GN.A0120W	345	229	32	388	24kg
G.GN.A0150W	362	251	32	440	30kg
G.GN.A0200W	400	285	36	510	40kg
G.GN.A0230W	420	250	25	460	46kg
G.GN.A0250W	430	285	40	557	50kg
G.GN.A0300W	455	290	40	600	60kg
G.GN.A0400W	526	318	40	661	80kg
G.GN.A0500W	531	318	40	713	100kg
G.GN.A0600W	580	380	45	610	120kg
G.GN.A0750W	600	380	40	650	150kg
G.GN.A0800W	610	400	50	700	160kg
G.GN.A1000W	620	400	55	800	200kg

碳化硅坩埚 Silicon carbide crucibles

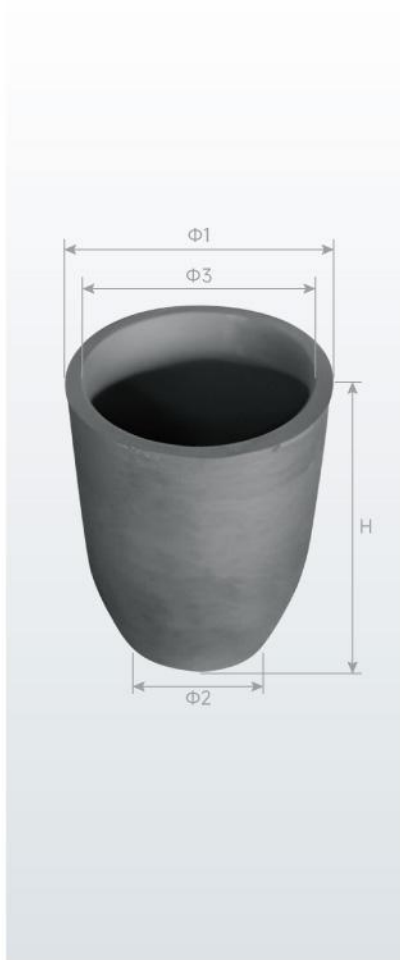

型号 Model	尺寸 Size (mm)				重量 Weight
	Φ1	Φ2	Φ3	H	
G.SC.14000W-B	1040	550	920	1320	560kg
G.SC.13000W-B	1040	550	920	1040	520kg
G.SC.12500W-B	900	450	800	1150	450kg
G.SC.12000W-B-1	890	450	790	1000	405kg
G.SC.12000W-B	890	450	790	900	380kg
G.SC.11500W-B	790	400	700	900	280kg
G.SC.11400W-B	720	400	630	900	270kg
G.SC.11300W-B	780	400	690	760	265kg
G.SC.11200W-B	720	400	630	780	245kg
G.SC.11000W-B	720	400	630	740	220kg
G.SC.10850W-B	650	330	580	850	230kg
G.SC.10840W-B	720	400	630	690	180kg
G.SC.10830W-B	620	330	540	800	210kg
G.SC.10750W-B	610	350	540	780	175kg
G.SC.10700W-B	610	350	540	720	165kg
G.SC.10703W-B	720	350	630	500	160kg
G.SC.10600W-B	530	300	460	780	125kg
G.SC.10500W-B	530	300	460	750	140kg
G.SC.10500W-B-D	530	300	430	720	115kg

型号 Model	尺寸 Size (mm)				重量 Weight
	Φ1	Φ2	Φ3	H	
G.SC.10450W-B	530	300	460	680	98kg
G.SC.10400W-B	470	380	400	800	96kg
G.SC.10370W-B	530	300	460	570	80kg
G.SC.10350W-B	470	780	400	680	85kg
G.SC.10653W-B	650	320	580	650	130kg
G.SC.10593W-B	620	320	550	620	135kg
G.SC.10530W-B	580	350	510	650	125kg
G.SC.10463W-B	580	320	510	600	110kg
G.SC.10353W-B	600	320	530	450	98kg
G.SC.10313W-B	530	310	470	530	95kg
G.SC.10300W-B	460	280	390	580	82kg
G.SC.10250W-B	430	260	470	540	70kg
G.SC.10200W-B	410	260	350	500	65kg
G.SC.10120W-B	350	230	250	450	52kg
G.SC.10110W-B	350	220	260	390	36kg
G.SC.10090W-B	310	210	250	350	31kg
G.SC.10060W-B	280	190	240	330	24kg
G.SC.10030W-B	220	150	180	270	9.5kg
G.SC.10020W-B	180	120	150	200	9kg

石墨陶瓷
Graphite and ceramic

碳化硅坩埚 Silicon carbide crucibles



型号 Model	尺寸 Size (mm)				重量 Weight
	Φ1	Φ2	Φ3	H	
G.SC.00010W	142	110	90	180	2kg
G.SC.00020W	182	142	130	225	4kg
G.SC.00030W	222	180	153	295	6kg
G.SC.00040W	237	195	170	290	8kg
G.SC.00050W	260	215	180	318	10kg
G.SC.00060W	275	225	180	330	12kg
G.SC.00080W	295	250	170	365	16kg
G.SC.00100W	340	280	200	365	20kg
G.SC.00120W	340	288	170	390	24kg
G.SC.00150W	370	310	150	452	30kg
G.SC.00150W-d	370	310	200	452	30kg
G.SC.00200W	400	345	190	510	40kg
G.SC.00200W-2	380	303	270	490	40kg
G.SC.00250W	445	380	220	565	50kg
G.SC.00300W	460	390	240	595	60kg
G.SC.00300-A-W	530	470	340	530	60kg
G.SC.00350W	500	420	260	633	70kg
G.SC.00370W	530	470	340	570	74kg
G.SC.00400W	520	455	250	665	80kg
G.SC.00450W	520	460	282	765	90kg
G.SC.00463W	280	500	310	620	93kg
G.SC.00480W	510	436	280	740	96kg

型号 Model	尺寸 Size (mm)				重量 Weight
	Φ1	Φ2	Φ3	H	
G.SC.00010W	535	465	280	725	100kg
G.SC.00020W	590	525	340	630	106kg
G.SC.00030W	540	465	290	780	100kg
G.SC.00040W	620	545	360	610	116kg
G.SC.00050W	560	470	410	810	120kg
G.SC.00060W	590	527	340	650	120kg
G.SC.00080W	620	538	310	640	130kg
G.SC.00100W	620	565	360	690	158kg
G.SC.00120W	630	550	290	720	160kg
G.SC.00150W	650	565	310	650	160kg
G.SC.00150W-d	620	558	360	710	160.5kg
G.SC.00200W	710	615	340	530	164kg
G.SC.00200W-2	710	622	340	600	182kg
G.SC.00250W	710	614	340	660	190kg
G.SC.00300W	638	570	350	790	200kg
G.SC.00300-A-W	616	538	420	820	200kg
G.SC.00350W	713	620	340	700	200kg
G.SC.00370W	715	615	450	730	210kg
G.SC.00400W	715	618	450	750	240kg
G.SC.00450W	670	575	300	870	250kg
G.SC.00463W	650	570	475	1000	260kg
G.SC.00480W	720	620	450	800	260kg

Graphite and ceramic



碳化硅坩埚 Silicon carbide crucibles

型号 Model	尺寸 Size (mm)				重量 Weight
	Φ1	Φ2	Φ3	H	
G.SC.10006W	121	97	83	154	1.2kg
G.SC.10025W	185	155	120	220	5kg
G.SC.10030W	218	172	135	200	6kg
G.SC.10040W	239	199	165	292	8kg
G.SC.10041W	240	190	175	270	8.2kg
G.SC.10080W	296	248	189	366	16kg
G.SC.10100W	320	270	210	390	20kg

型号 Model	尺寸 Size (mm)				重量 Weight
	Φ1	Φ2	Φ3	H	
G.SC.10120W	340	280	200	400	24kg
G.SC.10150W	355	295	200	530	30kg
G.SC.10200W	395	335	230	483	40kg
G.SC.10250W	425	365	230	550	50kg
G.SC.10300W	460	400	260	610	60kg
G.SC.10500W	420	360	300	840	100kg
G.SC.10700W	700	630	450	850	140kg



碳化硅坩埚 Silicon carbide crucibles

型号 Model	尺寸 Size (mm)				重量 Weight
	Φ1	Φ2	Φ3	H	
G.SC.Z1200W	530	430	500	1100	240kg
G.SC.Z1500W	610	510	590	1200	320kg
G.SC.Z0600W	480	400	450	800	160kg
G.SC.Z0500W	480	400	450	700	140kg
G.SC.Z0160W	280	230	240	470	42kg

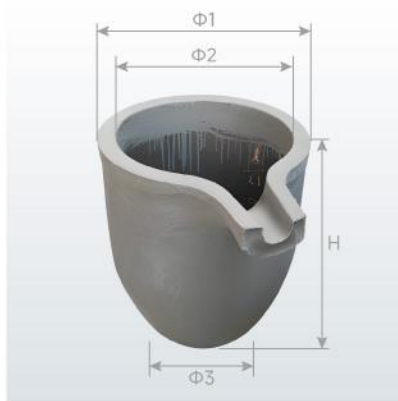

碳化硅坩埚 Silicon carbide crucibles

型号 Model	尺寸 Size (mm)				重量 Weight
	Φ1	Φ2	Φ3	H	
G.SC.12000W-Z	890	800	400	1150	460kg
G.SC.11800W-Z	790	700	400	900	290kg

石墨陶瓷
Graphite and ceramic

石墨铸造坩埚及棒 (可订制) Graphite casting crucible and stopper (tailored)



GALLONI/VCM石墨铸造坩埚及棒 Graphite casting crucible and stopper for Galloni/VCM

名称 Description	型号 Model	尺寸 Size (mm)	重量 Weight	机器 Machine
VCM石墨铸造坩埚 Graphite casting crucible	G.GC.V0040	Φ78×H120 Hole OD: 8	530g	Galloni/ VCM
VCM石墨铸造坩埚塞棒 Graphite stopper	G.GC.V004S	Φ19×H200 Hole OD: 4.5	70g	



VPC063石墨铸造坩埚及棒 Graphite casting crucible and stopper for VPC0-63

名称 Description	型号 Model	尺寸 Size (mm)	重量 Weight	机器 Machine
VPC063石墨铸造坩埚 Graphite casting crucible	G.GC.V0016	Φ74×H106 Hole OD: 7	/	VPC-063
VPC063石墨铸造坩埚塞棒 Graphite stopper	G.GC.V003S	Φ13.5×H163 Hole OD: 7	/	



VPC066石墨铸造坩埚及棒 Graphite casting crucible and stopper for VPC-066

名称 Description	型号 Model	尺寸 Size (mm)	重量 Weight	机器 Machine
VPC066石墨铸造坩埚 Graphite casting crucible	G.G.C.V0030	Φ74×H136 Hole OD: 7	455g	VPC-066
VPC066石墨铸造坩埚 (斜面) Graphite casting crucible (slope side)	G.G.C.V003X	Φ74×H136 Hole OD: 7	/	
VPC066石墨铸造坩埚塞棒 Graphite stopper	G.G.C.V003S	Φ13.5×H163 Hole OD: 5	34g	



VC400石墨铸造坩埚及棒 Graphite casting crucible and stopper for VC400

名称 Description	型号 Model	尺寸 Size (mm)	重量 Weight	机器 Machine
VC400石墨铸造坩埚 Graphite casting crucible	G.G.C.V0100	Φ68×H120 Hole OD: 8	465g	VC400
VC400石墨铸造坩埚塞棒 Graphite stopper	G.G.C.V010S	Φ12×H175	38g	



VC500石墨铸造坩埚及棒 Graphite casting crucible and stopper for VC500

名称 Description	型号 Model	尺寸 Size (mm)	重量 Weight	机器 Machine
VC500石墨铸造坩埚 Graphite casting crucible	G.G.C.V0110	Φ78×H120 Hole OD: 8	/	VC500
VC500石墨铸造坩埚塞棒 Graphite stopper	G.G.C.V011S	Φ19.5×H175 Hole OD: 7	/	



VC600石墨铸造坩埚及棒 Graphite casting crucible and stopper for VC600

名称 Description	型号 Model	尺寸 Size (mm)	重量 Weight	机器 Machine
VC600石墨铸造坩埚 Graphite casting crucible	G.G.C.V0090	Φ78×H120 Hole OD: 6	650	VC600
VC600石墨铸造坩埚 Graphite casting crucible	G.G.C.V0010	Φ78×H120 Hole OD: 8	660	
VC600石墨铸造坩埚塞棒 Graphite stopper	G.G.C.V001S	Φ12×H180	36	



安井K2/KT17石墨铸造坩埚及棒 Graphite casting crucible and stopper for Yasui K2E/KT17

名称 Description	型号 Model	尺寸 Size (mm)	重量 Weight	机器 Machine
安井K2/KT17石墨铸造坩埚 Graphite casting crucible	G.GC.K0010	Φ70×H128 Hole OD: 8	270 g	安井 K2E/KT17 Yasui K2E/KT17
安井K2/KT17石墨铸造坩埚 Graphite casting crucible with coating	G.GC.K0010-10	Φ70×H128 Hole OD: 10	270 g	
安井K2/KT17石墨铸造坩埚 (涂层) Graphite casting crucible	G.GC.K001T	Φ70×H128 Hole OD: 8	270 g	
安井K2/KT17石墨铸造坩埚塞棒 Graphite stopper	G.GC.K001S	Φ23.5×H152 Hole OD: 7	40 g	



安井K3石墨铸造坩埚及棒 Graphite casting crucible and stopper for Yasui K3

名称 Description	型号 Model	尺寸 Size (mm)	重量 Weight	机器 Machine
安井K3石墨铸造坩埚 Graphite casting crucible	G.GC.K0020	Φ65×H73 Hole OD: 8	210 g	安井K3 Yasui K3
安井K3石墨铸造坩埚塞棒 Graphite stopper	G.GC.K002S	Φ21.5×H133 Hole OD: 6.5	35 g	



安井K5石墨铸造坩埚及棒 Graphite casting crucible and stopper for Yasui K5

名称 Description	型号 Model	尺寸 Size (mm)	重量 Weight	机器 Machine
安井K5石墨铸造坩埚 Graphite casting crucible	G.GC.K0030	Φ70×H89 Hole OD: 8	220 g	安井K5 Yasui K5
安井K5石墨铸造坩埚塞棒 Graphite stopper	G.GC.K003S	Φ21×H135 Hole OD: 6.5	35 g	



安井KT18石墨铸造坩埚及棒 Graphite casting crucible and stopper for Yasui KT18

名称 Description	型号 Model	尺寸 Size (mm)	重量 Weight	机器 Machine
安井KT18石墨铸造坩埚 Graphite casting crucible	G.GC.K0040	Φ70×H128 Hole OD: 8	215 g	安井KT18 Yasui KT18
安井KT18石墨铸造坩埚塞棒 Graphite stopper	G.GC.K004S	Φ16×H145.5 Hole OD: 7	40 g	



安井KT15S石墨铸造坩埚及棒
Graphite casting crucible and stopper for Yasui KT15S

名称 Description	型号 Model	尺寸 Size (mm)	重量 Weight	机器 Machine
安井KT15S石墨铸造坩埚 Graphite casting crucible	G.GC.K0090	Φ62×H87.5 Hole OD: 7	/	安井KT15S Yasui KT15S
安井KT15S石墨铸造坩埚塞棒 Graphite stopper	G.GC.K009S	Φ13×H136 Hole OD: 7	35 g	



国产机石墨铸造坩埚及棒
Graphite casting crucible and stopper for China casting machine

名称 Description	型号 Model	尺寸 Size (mm)	重量 Weight	机器 Machine
国产机石墨铸造坩埚 Graphite casting crucible	G.GC.G0020	Φ76×H122 Hole OD: 8	240 g	国产铸造机 China casting machine
国产机石墨铸造坩埚塞棒 Graphite stopper	G.GC.G002S	Φ15×H168 Hole OD: 7	35 g	



Neutec石墨铸造坩埚及棒
Graphite casting crucible and stopper for Neutec

名称 Description	型号 Model	尺寸 Size (mm)	重量 Weight	机器 Machine
Neutec J5石墨铸造坩埚 Graphite casting crucible	G.GC.J0010	Φ75×H122.5 Hole OD: 9.5	490 g	Neutec
Neutec J5石墨铸造坩埚塞棒 Graphite stopper	G.GC.J001S	Φ15×H222 Hole OD: 8	30 g	
Neutec J10石墨铸造坩埚 Graphite casting crucible	G.GC.J0020	Φ90×H110 Hole OD: 9.5	/	
Neutec 10石墨铸造坩埚塞棒 Graphite stopper	G.GC.J002S	Φ15×H250 Hole OD: 8	/	
Neutec J15石墨铸造坩埚 Graphite casting crucible	G.GC.J0050	Φ100×H124 Hole OD: 1.5	/	
Neutec J15石墨铸造坩埚塞棒 Graphite stopper	G.GC.J005S	Φ15×H220 Hole OD: 8	/	
Neutec J15石墨铸造坩埚 Graphite casting crucible	G.GC.J0060	Φ100×H124 Hole OD: 1.8	/	
Neutec J15石墨铸造坩埚塞棒 Graphite stopper	G.GC.J006S	Φ15×H250	/	
Neutec单孔石墨撒珠坩埚 Graphite granulation crucible with 1 hole	G.GCG.J0010	Φ75×H110 Hole OD: 1.8×1	/	
Neutec五孔石墨撒珠坩埚 Graphite granulation crucible with 5 hole	G.GCG.J0020	Φ75×H110 Hole OD: 1.8×5	/	
Neutec单孔石墨撒珠坩埚 Graphite granulation crucible with 1 hole	G.GCG.J0050	Φ100×H124 Hole OD: 1.5×1	510	
Neutec五孔石墨撒珠坩埚 Graphite granulation crucible with 5 hole	G.GCG.J0060	Φ100×H124 Hole OD: 1.8×5	947	



田边石墨铸造坩埚及棒
Graphite casting crucible and stopper for Tanabe

名称 Description	型号 Model	尺寸 Size (mm)	重量 Weight	机器 Machine
田边石墨铸造坩埚 Graphite casting crucible	G.GC.T0010	Φ64×H130 Hole OD: 8	240 g	田边 Tanabe
田边石墨铸造坩埚塞棒 Graphite stopper	G.GC.T001S	Φ16×H210	35 g	



田边石墨铸造坩埚及棒
Graphite casting crucible and stopper for Tanabe

名称 Description	型号 Model	尺寸 Size (mm)	重量 Weight	机器 Machine
田边石墨铸造坩埚 Graphite casting crucible	G.GC.T0020	Φ63.5×H100 Hole OD: 8	240 g	田边 Tanabe
田边石墨铸造坩埚塞棒 Graphite stopper	G.GC.T002S	Φ14×H150 Hole OD: 5.5	35 g	



Top Cast石墨铸造坩埚及棒
Graphite casting crucible and stopper for Top Cast

名称 Description	型号 Model	尺寸 Size (mm)	重量 Weight	机器 Machine
TOP CAST石墨铸造坩埚 Graphite casting crucible	G.GC.T0030	Φ77×H120 Hole OD: 5.5	/	Top Cast
TOP CAST石墨铸造坩埚塞棒 Graphite stopper	G.GC.T003S	Φ11×H160	/	



金江石墨铸造坩埚及棒
Graphite casting crucible and stopper for Jinjiang of China

名称 Description	型号 Model	尺寸 Size (mm)	重量 Weight	机器 Machine
金江石墨铸造坩埚 Graphite casting crucible	G.GC.G0010	Φ82.3×H111.5 Hole OD: 7	240 g	国产金江 Jinjiang of China
金江石墨铸造坩埚塞棒 Graphite stopper	G.GC.G001S	Φ15×H140 Hole OD: 6.5	35 g	
金江石墨撒珠坩埚 Graphite granulation crucible	G.GC.G0010	Φ82×H96 Hole OD: 2×5	/	



AVC-II石墨铸造坩埚及棒
Graphite casting crucible and stopper for AVC-II

名称 Description	型号 Model	尺寸 Size (mm)	重量 Weight	机器 Machine
AVC-II石墨铸造坩埚 Graphite casting crucible	G.GC.AVC-II	Φ78×H130 Hole OD: 8	470 g	AVC-II
DVC石墨铸造坩埚塞棒 Graphite stopper	G.GC.DVCS	Φ13.5×H165 Hole OD: 4.5	35 g	AVC / DVC



DVC石墨铸造坩埚及棒
Graphite casting crucible and stopper for DVC

名称 Description	型号 Model	尺寸 Size (mm)	重量 Weight	机器 Machine
DVC石墨铸造坩埚 Graphite casting crucible	G.GC.DVC	Φ77×H115 Hole OD: 7	470 g	DVC
DVC石墨铸造坩埚塞棒 Graphite stopper	G.GC.DVCS	Φ13.5×H165 Hole OD: 4.5	35 g	



Italimpianti石墨铸造坩埚及棒
Graphite casting crucible and stopper for Italimpianti

名称 Description	型号 Model	尺寸 Size (mm)	重量 Weight	机器 Machine
Italimpianti石墨铸造坩埚 Graphite casting crucible	G.GC.I0010	Φ80×H125 Hole OD: 4	510 g	Italimpianti
Italimpianti石墨铸造坩埚塞棒 Graphite stopper	G.GC.I001S	Φ19×H230 Hole OD: 8	30 g	



Italimpianti石墨铸造坩埚及棒
Graphite casting crucible and stopper for Italimpianti

名称 Description	型号 Model	尺寸 Size (mm)	重量 Weight	机器 Machine
ITALIMPIANTI石墨铸造坩埚 Graphite casting crucible	G.GC.I0020	Φ80×H93.2 Hole OD: 8	375 g	Italimpianti
ITALIMPIANTI石墨铸造坩埚塞棒 Graphite stopper	G.GC.I002S	Φ19×H230 Hole OD: 8	35 g	



Galloni G40石墨铸造坩埚及石英外套

Graphite casting crucible and ceramic shield for Galloni G40

名称 Description	型号 Model	尺寸 Size (mm)				重量 Weight	机器 Machine
		Φ1	Φ2	Φ3	H		
G40石墨铸造坩埚 Graphite casting crucible	G.GC.G0040	40	30	32	96	100 g	Galloni G40
C40石英外套 Ceramic shield	C.CC.00040	62	42	44	107	140 g	



GALLONI G350石墨铸造坩埚及石英外套

Graphite casting crucible and ceramic shield for Galloni G350

名称 Description	型号 Model	尺寸 Size (mm)				重量 Weight	机器 Machine
		Φ1	Φ2	Φ3	H		
G350石墨铸造坩埚 Graphite casting crucible	G.GC.G0350	60	47	45	140	275 g	Galloni G350
C350石英外套 Ceramic shield	C.CC.00350	83	62	64	150	305 g	

连续铸造机上模/下模 (订制)

Continuous casting machine upper mould/graphite Die (tailored)



名称 Description	型号 Model	尺寸 Size (mm)				重量 Weight	机器 Machine
		Φ1	Φ2	Φ3	H		
上模 upper mould	G.GD.3000A	60	78	/	120	/	连续铸造机 Continuous casting machine
下模 Graphite Die	G.GD.3000B	50	8	/	104	/	
上模 upper mould	G.GD.5000A	85	118	6.5	140	/	
下模 Graphite Die	G.GD.5000B	60	30x4	/	104	/	
上模 upper mould	G.GD.8000A	80	120	6.5	180	2340g	
下模 Graphite Die	G.GD.8000B	50	8	/	100	345g	

石墨棒 (可订制)

Graphite stirring rod (tailored)



名称 Description	型号 Model	尺寸 Size (mm)	重量 Weight
石墨棒 graphite stirring rod	G.GS.008300	Φ8×H300	25 g
石墨棒 graphite stirring rod	G.GS.010355	Φ10×H355	45 g
石墨棒 graphite stirring rod	G.GS.012355	Φ12×H355	55 g
石墨棒 graphite stirring rod	G.GS.014355	Φ14×H355	85 g
石墨棒 graphite stirring rod	G.GS.015355	Φ15×H355	/
石墨棒 graphite stirring rod	G.GS.016355	Φ16×H355	/



石墨垫圈 (可订制) Graphite gasket (tailored)

名称 Description	型号 Model	尺寸 Size (mm)
2寸石墨垫圈 2" graphite gasket (thin)	G.GG.B0002W	Φ72×58×H2mm
2.5寸石墨垫圈 2.5" graphite gasket (thin)	G.GG.B0025W	Φ96×68×H2mm
3寸薄石墨垫圈 3" graphite gasket (thin)	G.GG.B0003W	Φ112×82×2mm
3寸厚石墨垫圈 3" graphite gasket (thick)	G.GG.H0003W	Φ112×82×5mm
3.5寸薄石墨垫圈 3.5" graphite gasket (thin)	G.GG.B0035W	Φ126×95×H2mm
3.5寸厚石墨垫圈 3.5" graphite gasket (thick)	G.GG.H0035W	Φ126×95×H5mm
4寸薄石墨垫圈 4" graphite gasket (thin)	G.GG.B0004W	Φ138×Φ109×H2mm
4寸厚石墨垫圈 4" graphite gasket (thick)	G.GG.H0004W	Φ138×Φ109×H5mm
5寸薄石墨垫圈 5" graphite gasket (thin)	G.GG.B0005W	Φ160×Φ137×H2mm
5寸厚石墨垫圈 5" graphite gasket (thick)	G.GG.H0005W	Φ160×Φ137×H5mm



石墨纸 (可订制) Graphite sheet (tailored)

名称 Description	型号 Model	尺寸 Size (mm)
0.2mm厚石墨纸 0.2 mm thickness graphite sheet	G.GP.H0020	H0.2×W600
0.3mm厚石墨纸 0.4 mm thickness graphite sheet	G.GP.H0030	/
0.4mm厚石墨纸 0.4 mm thickness graphite sheet	G.GP.H0040	H0.4×W1000
0.5mm厚石墨纸 0.5 mm thickness graphite sheet	G.GP.H0050	H0.5×W1000
0.6mm厚石墨纸 0.6 mm thickness graphite sheet	G.GP.H0060	H0.6×W1000
0.8mm厚石墨纸 0.8 mm thickness graphite sheet	G.GP.H0080	H0.8×W1000
1.0mm厚石墨纸 1.0 mm thickness graphite sheet	G.GP.H0100	/



石墨油槽 (可订制) Graphite ingot mould (tailored)

名称 Description	型号 Model	尺寸 Size (mm)						重量 Weight
		L1	W1	H1	L2	W2	H2	
100g石墨油槽 100 g graphite ingot mould	G.GI.Y0100	55	40	20	35	20	10	65g
200g石墨油槽 200 g graphite ingot mould	G.GI.Y0200	70	45	20	50	25	10	90g
250g石墨油槽 250 g graphite ingot mould	G.GI.Y0250	67	50	26	47	25	16	125g
300g石墨油槽 300 g graphite ingot mould	G.GI.Y0300	70	57	20	50	37	10	108g
400g石墨油槽 400 g graphite ingot mould	G.GI.Y0400	70	67	20	50	47	10	125g
500g石墨油槽 500 g graphite ingot mould	G.GI.Y0500	70	67	26	50	47	16	155g
1kg石墨油槽 1 kg graphite ingot mould	G.GI.Y1000	135	42	32	115	22	22	130g
2kg石墨油槽 2 kg graphite ingot mould	G.GI.Y2000	160	48	38	140	28	28	325g
3kg石墨油槽 3 kg graphite ingot mould	G.GI.Y3000	175	52	42	155	32	32	390g

C 定制精雕石墨模具 CUSTOMIZF FINE GRAPHITE DI

石墨陶瓷
Graphite and ceramic



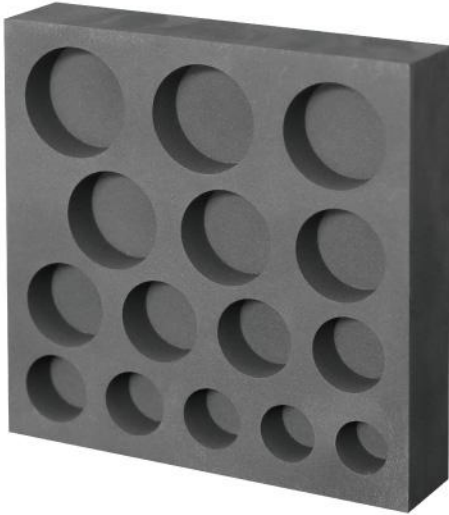

型号 Model: G.GI.100100021
尺寸 Size: 100x100x21mm

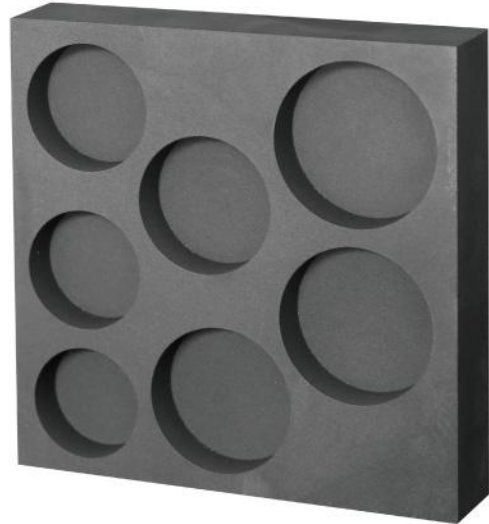

型号 Model: G.GI.110110021
尺寸 Size: 110x110x21mm



型号 Model: G.GI.200150021
尺寸 Size: 200x150x21mm



型号 Model: G.GI.150100021
尺寸 Size: 150x100x21mm



型号 Model: G.GI.100100021-6
尺寸 Size: 100x100x21mm



型号 Model: G.GI.100100021-4
尺寸 Size: 100x100x21mm



G型号 Model: .GI.100100021-5
尺寸 Size: 100x100x21mm

始创于
Graphite and ceramic





始创于
Graphite and ceramic

铝镀薄膜生产用的特种石墨 / 硅化坩埚 Specialty Graphite / Silicon Carbide Crucibles for Aluminum Coating Film Production

真空镀铝坩埚主要用于特种石墨/硅化坩埚类加工程度，特别是在真空镀铝过程中起到关键作用。其应用领域包括专用设备制造业，尤其是在太阳能机器人、无人机、可穿戴智能产品、电动车等民用和军用领域的广泛应用。

Vacuum aluminum coating crucibles are primarily used in the processing of specialty graphite/silicon carbide crucibles and play a critical role in the vacuum aluminum coating process. Their applications span the specialized equipment manufacturing industry, with widespread use in both civilian and military fields such as solar-powered robots, drones, wearable smart devices, and electric vehicles.



产品优势 PRODUCT ADVANTAGES

- 1、针对真空镀铝的工艺要求，我司专门开发出了特种石墨材料，体积密度高、气孔率低，最大程度抵御了熔融铝液和气态铝微粒的侵蚀。
- 2、石墨材料经过特殊工艺处理，抗氧化性能强，消耗低，使用寿命长。
- 3、石墨材料纯度高、灰分低，在真空蒸镀过程中不产生有害挥发性物质，避免铝薄膜的表面形成麻床点、沙眼和针孔等缺陷，为镀铝薄膜提供了质量保障。
- 4、可与特种涂层进行配合，涂层结合力是普通涂层的十倍以上，寿命平均可提升3到5倍以上。

1. To meet the process requirements of vacuum aluminum coating, our company has specifically developed a specialty graphite material with high bulk density and low porosity, which maximally resists erosion from molten aluminum and gaseous aluminum particles.
2. The graphite material undergoes special processing, offering strong oxidation resistance, low consumption, and a long service life.
3. The graphite material has high purity and low ash content, preventing the release of harmful volatile substances during vacuum evaporation coating. This avoids defects such as pitting, sand holes, and pinholes on the surface of the aluminum-coated film, ensuring quality.
4. It can be combined with specialty coatings, providing coating adhesion more than ten times that of ordinary coatings and extending the average service life by 3 to 5 times or more.

产品加工/生产 PRODUCT PROCESSING/PRODUCTION

坩埚可进行二次等静压处理，可进行抛光处理、涂层处理、改性处理、提纯处理、抗铝侵蚀处理，尺寸精确，表面光洁。

The crucibles can undergo secondary isostatic pressing and can be polished, coated, modified, purified, and treated for aluminum erosion resistance. They feature precise dimensions and a smooth surface.

使用寿命 SERVICE LIFE

根据真空镀铝工艺和产品质量要求的不同，生产的石墨坩埚可以连续使用24-168小时，或完成镀膜生产30-300次。

Depending on the vacuum aluminum coating process and product quality requirements, the produced graphite crucibles can be used continuously for 24-168 hours or complete 30-300 coating production cycles.

生产使用 PRODUCTION USAGE

真空镀铝是在真空条件下将金属铝蒸镀在薄膜基材的表面而形成复合薄膜的一种生产工艺。BOPET、BONY、BOPPE、PVC等塑料薄膜镀铝多采用直接蒸镀工艺，纸张、皮革等镀铝多采用蒸镀-转移工艺。

石墨坩埚是真空镀铝薄膜生产中普遍使用的消耗性部件，石墨坩埚的质量好坏直接影响到镀铝薄膜的产品质量和生产成本。真空镀铝对石墨坩埚的质量要求十分苛刻，目前能够生产并稳定供货的企业不多。

Vacuum aluminum coating is a production process where metal aluminum is evaporated and deposited onto the surface of film substrates under vacuum conditions to form composite films. BOPET, BONY, BOPP, PE, PVC, and other plastic films often use direct evaporation coating, while paper, leather, and other materials typically employ the transfer coating process.

Graphite crucibles are commonly used consumable components in vacuum aluminum coating film production. The quality of the graphite crucible directly impacts the product quality and production cost of the aluminum-coated film. The quality requirements for graphite crucibles in vacuum aluminum coating are extremely stringent, and there are currently few companies capable of producing and supplying them stably.

主要技术指标/技术工艺 KEY TECHNICAL INDICATORS/TECHNICAL PROCESSES

(技术来源于德国材料技术与韩国涂层技术):
(Technology sourced from German material technology and Korean coating technology):

我司技术指标

平均真空熔铝寿命(次数): 30-300
硬度(肖氏): 70-90°
抗压强度(kgf/cm²): 600-800
电阻率(Ω·mm/m): 4-16
体积密度(g/cm³): 1.9-2.2

OUR COMPANY'S TECHNICAL INDICATORS:

Average Vacuum Aluminum Melting Life (Cycles): 30-300
Hardness (Shore): 70-90°
Compressive Strength (kgf/cm²): 600-800
Resistivity (Ω·mm/m): 4-16
Bulk Density (g/cm³): 1.9-2.2

市场通用技术指标

平均真空熔铝寿命(次数): 10-100
硬度(肖氏): 40-50°
抗压强度(kgf/cm²): 500-600
电阻率(Ω·mm/m): 5-20
体积密度(g/cm³): 1.75-1.84

INDUSTRY STANDARD TECHNICAL INDICATORS:

Average Vacuum Aluminum Melting Life (Cycles): 10-100
Hardness (Shore): 40-50°
Compressive Strength (kgf/cm²): 500-600
Resistivity (Ω·mm/m): 5-20
Bulk Density (g/cm³): 1.75-1.84

坩埚外部涂层 Crucible External Coating

功能性涂层是一种薄的覆盖物可以被用在坩埚上显著提高性能，减少杂质在熔化和保温纯合金时。它也能防止浮渣堆积从而使得清洁更快更轻松。

Functional coating is a thin covering that can be applied to crucibles to significantly enhance performance and reduce impurities during the melting and holding of pure alloys. It also prevents dross buildup, thereby enabling faster and easier cleaning.

应用：釉层可以被用在铝合金应用、锌蒸馏、贵金属和纯铜熔化。

APPLICATIONS: Glaze coatings can be used for aluminum alloy applications, zinc distillation, precious metals, and pure copper melting.

预热/第一次使用：化学连接的釉层在被应用涂层的蒸馏或者坩埚的开始/加热流程不会以任何方式影响或改变。

PREHEATING / FIRST USE: The chemically bonded glaze does not affect or alter the initial start-up/heating process of the coated distillation pot or crucible in any way.



釉层挑选表格 GLAZE SELECTION TABLE

釉层 Glaze Type	坩埚型号 Applicable Crucible Models	用途 Purpose	最高使用温度 Maximum Service Temperature
频感涂层 Frequency Induction Coating	所有类型坩埚 All Types	增强表面频感率和高导率、XY轴方向热导率、降低Z轴热导率，使得坩埚受热均匀，并且对外热扩散率直线降低、可降低设备自身的功率大小。 Enhances surface frequency response & high conductivity, thermal conductivity in X/Y axis, reduces Z-axis thermal conductivity. Promotes uniform crucible heating, significantly reduces external thermal diffusion, and can reduce the equipment's own power requirements.	1750°C 1100°C
火焰烧结涂层 Flame Sintering Coating		极强的抗明火性能，以及抗火焰冲刷性能、高温下可二次结晶、降低火焰对坩埚的冲刷。 Excellent resistance to open flame and flame scouring. Can undergo secondary crystallization at high temperatures, reducing flame erosion on the crucible.	1450°C 980°C
抗腐蚀涂层 Anti-Corrosion Coating		可使用于强酸强碱的环境，可用于各种的化工使用场景可进行偏酸或偏碱性涂层处理，使得酸或碱环境使用大大增强。 Suitable for strong acid/alkali environments and various chemical applications. Can be tailored for acidic or alkaline conditions, significantly enhancing performance in these environments.	600°C 900°C 1200°C
抗氧化涂层 Anti-Oxidation Coating		增强坩埚的抗氧化性能、使得坩埚在有氧环境下的寿命大大增强。 Enhances the crucible's oxidation resistance, significantly increasing service life in oxygen-containing atmospheres.	900°C 1200°C 1800°C 2200°C

坩埚内部涂层 Crucible Internal Coating

功能性涂层是一种薄的覆盖物可以被用在坩埚上显著提高性能，减少杂质在熔化和保温纯合金时。它也能防止浮渣堆积从而使得清洁更快更轻松。

Functional coating is a thin covering that can be applied to crucibles to significantly enhance performance and reduce impurities during the melting and holding of pure alloys. It also prevents dross buildup, thereby enabling faster and easier cleaning.

应用：釉层可以被用在铝合金应用、锌蒸馏、贵金属和纯铜熔化。

APPLICATIONS: Glaze coatings can be used for aluminum alloy applications, zinc distillation, precious metals, and pure copper melting.

预热/第一次使用：化学连接的釉层在被应用涂层的蒸馏或者坩埚的开始/加热流程不会以任何方式影响或改变。

PREHEATING / FIRST USE: The chemically bonded glaze does not affect or alter the initial start-up/heating process of the coated distillation pot or crucible in any way.

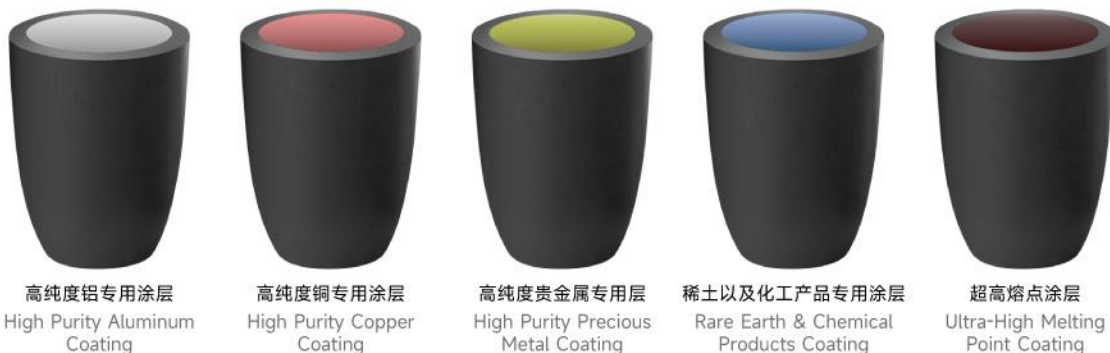

釉层挑选表格 GLAZE SELECTION TABLE

釉层 Glaze Type	坩埚型号 Applicable Crucible Models	使用金属 Applicable Metals	用途 Purpose	建议使用温度 Recommended Temperature
高纯度铝专用涂层 High Purity Aluminum Coating	所有类型坩埚 All Types	铝，超纯铝99.999%铝合金，回收铝材。 Aluminum, Ultra-Pure Al (99.999%), Aluminum Alloys, Recycled Aluminum.	减少浮渣粘附，限制金属污染，可做超高纯度熔炼。 Reduces dross adhesion, limits metal contamination, suitable for ultra-high purity melting.	700°C-900°C
高纯度铜专用涂层 High Purity Copper Coating		铜，紫铜、黄铜、无氧铜以及回收铜材。 Copper, Red Copper, Brass, Oxygen-Free Copper, Recycled Copper.	减少浮渣粘附，限制金属污染，适用于全系列铜。 Reduces dross adhesion, limits metal contamination, suitable for the full copper series.	1100°C-1250°C
高纯度贵金属专用层 High Purity Precious Metal Coating		贵金属，金、银、铂 Precious Metals: Gold, Silver, Platinum	减少浮渣粘附，限制金属污染，提纯金属。 Reduces dross adhesion, limits metal contamination, purifies metals.	1100°C-1200°C 1500°C-1700°C
稀土以及化工产品专用涂层 Rare Earth & Chemical Products Coating	SIC, SIC-C, C-SIC-C, N-SIC-C等系列坩埚 SIC, SIC-C, C-SIC-C, N-SIC-C Series	稀土，钪、镧、铈、氧化物，单质品等。 Rare Earths: Scandium, Lanthanum, Praseodymium, Oxides, Elements, etc.	减少浮渣粘附，限制金属污染，抗酸碱腐蚀以及浸润。 Reduces dross adhesion, limits metal contamination, resists acid/alkali corrosion and infiltration.	1000°C-1350°C 1500°C-1750°C
超高熔点涂层 Ultra-High Melting Point Coating	E/K, LG, ZP系列坩埚 E/K, LG, ZP Series	钛、钼、钨、铼、钨、钽等 Titanium, Molybdenum, Tungsten, Rhenium, Osmium, Tantalum, etc.	减少浮渣粘附，限制金属污染，降低金属熔点，提高熔炼产品质量。 Titanium, Molybdenum, Tungsten, Rhenium, Osmium, Tantalum, etc.	建议使用 2000°C以下 Recommended below 2000°C

涂层坩埚 Coated Crucibles

功能性涂层是一种薄的覆盖物可以被用在坩埚上显著提高性能，减少杂质在熔化和保温纯合金时。它也能防止浮渣堆积从而使得清洁更快更轻松。

Functional coating is a thin covering that can be applied to crucibles to significantly enhance performance and reduce impurities during the melting and holding of pure alloys. It also prevents dross buildup, thereby enabling faster and easier cleaning.

应用：釉层可以被用在铝合金应用、锌蒸馏、贵金属和纯铜熔化。

APPLICATIONS: Glaze coatings can be used for aluminum alloy applications, zinc distillation, precious metals, and pure copper melting.

预热/第一次使用：化学连接的釉层在被应用涂层的蒸馏或者坩埚的开始/加热流程不会以任何方式影响或改变。

PREHEATING / FIRST USE: The chemically bonded glaze does not affect or alter the initial start-up/heating process of the coated distillation pot or crucible in any way.



PRO 涂层
PRO Coating



STAR 涂层
STAR Coating



Res Coat 涂层
Res Coat Coating



Pure Melt 涂层
Pure Melt Coating

釉层挑选表格 GLAZE SELECTION TABLE

釉层 Glaze Type	坩埚型号 Applicable Crucible Models	合金 Applicable Alloys/Metals	用途 Purpose	最高使用温度 Maximum Service Temperature
PRO 涂层 PRO Coating	所有类型坩埚 All Types	纯铝(99.999%) & 铝合金、锌蒸馏、贵金属。 Pure Aluminum (99.999%) & Aluminum Alloys, Zinc Distillation, Precious Metals.	减少浮渣粘结，限制金属污染。 Reduces dross adhesion, limits metal contamination.	1600°C
STAR 涂层 STAR Coating		纯铝(99.999%) & 铝合金、贵金属。 Pure Aluminum (99.999%) & Aluminum Alloys, Precious Metals.	减少浮渣粘结，限制金属污染。 Reduces dross adhesion, limits metal contamination.	1000°C
Res Coat 涂层 Res Coat Coating		铜和铜合金贵金属包含使用化学试剂。 Copper and Copper Alloys, Precious Metals (includes use with chemical reagents).	减少浮渣粘结，限制金属污染。 Increase corrosion resistance Limit metal contamination.	1600°C
Pure Melt 涂层 Pure Melt Coating		锌蒸馏、纯铜熔化。 Zinc Distillation, Pure Copper Melting.	减少浮渣粘结，限制金属污染。 Reduces dross adhesion, limits metal contamination.	1500°C



石墨石英
Graphite and ceramic

石英系列 Ceramic series

以精选熔融石英为主要原料，用现代陶瓷技术加工制成，主要用于铂金、黄金及其它高温合金的熔化，产品纯度高，耐侵蚀，主成份SiO₂含量不小于99.99%，杂质（K₂O、Na₂O、Fe₂O₃）含量不大于0.10%，强度高，常温耐压强度≥70MPa，热震性高。

Selected quality quartz as materials, combined with advanced ceramic processing workmanship, mainly used for platinum, gold, and other high temp alloy melting, high purity, anti-corrosion, anti strong acid and strong alkali. The main component is SiO₂≥99.99%, and other materials (K₂O, Na₂O, Fe₂O₃) less than 0.10%, good hardness, compress resistance ≥70MPa, high thermal shock resistance, There is no crack even after hundred sudden heat and sudden cold.



石墨石英系列产品适用的设备品牌
The suitable equipment brand of graphite and ceramic series



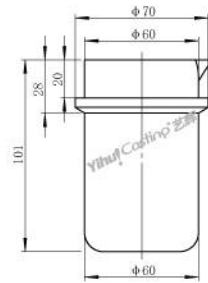

1公斤石英熔金杯

型号: C.CM.B1000
重量: 337g

1kg ceramic melting crucible

Model: C.CM.B1000-A
Weight: 337g

包装 Package: 450x300x240mm (48pcs/Carton)

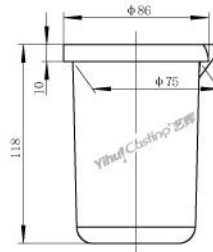

2公斤石英熔金杯

型号: C.CM.B2000
重量: 484g

2kg ceramic melting crucible

Model: C.CM.B2000-A
Weight: 484g

包装 Package: 450x300x240mm (25pcs/Carton)

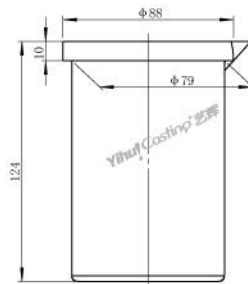
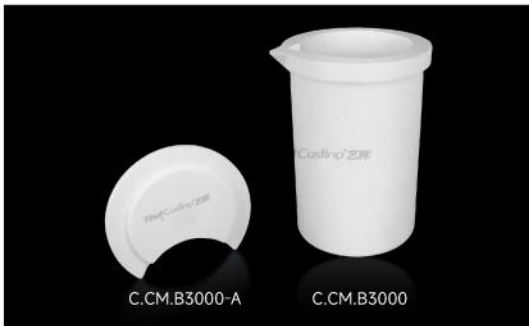

3公斤石英熔金杯

型号: C.CM.B3000
重量: 543g

3kg ceramic melting crucible

Model: C.CM.B2000-A
Weight: 543g

包装 Package: 420x315x348mm (24pcs/Carton)

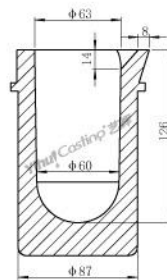

4公斤石英熔金杯-B

型号: C.CM.B4000-B
重量: 864g

4kg ceramic melting-B crucible

Model: C.CM.B4000-B
Weight: 864g

包装 Package: 420x315x348mm (24pcs/Carton)

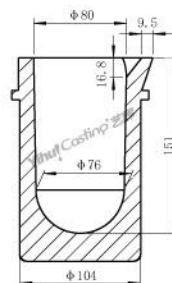

6公斤石英熔金杯

型号: C.CM.B6000
重量: 1500g

6kg ceramic melting crucible

Model: C.CM.B6000
Weight: 1500g

包装 Package: 440x310x270mm (7pcs/Carton)

石英熔金杯
Ceramic melting crucible

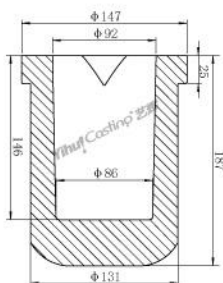

8公斤石英熔金杯
型号: C.CM.B8000
重量: 3000g

8kg ceramic melting crucible
Model: C.CM.B8000
Weight: 3000g

包装 Package: 440x310x350mm (10pcs/Carton)

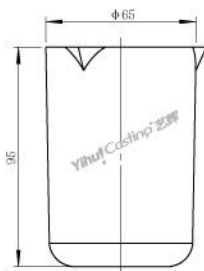

1公斤三嘴石英熔金杯
型号: C.CM.E1000
重量: 245g

1kg ceramic melting crucible
Model: C.CM.E1000
Weight: 245g

包装 Package: 450x300x240mm (66pcs/Carton)

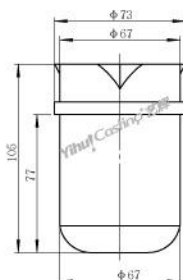

1.5公斤三嘴石英熔金杯
型号: C.CM.A1500
重量: 270g

1.5kg ceramic melting crucible
Model: C.CM.A1500
Weight: 270g

包装 Package: 450x300x240mm (48pcs/Carton)

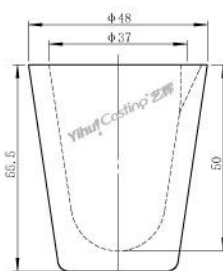

C200石英熔金杯
型号: C.CM.C0200
重量: 64g

C200 ceramic melting crucible
Model: C.CM.C0200
Weight: 64g

包装 Package: 450x300x240mm (135pcs/Carton)

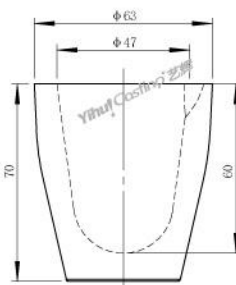

C350石英熔金杯
型号: C.CM.C0350
重量: 144g

C350 ceramic melting crucible
Model: C.CM.C0350
Weight: 144g

包装 Package: 450x300x240mm (105pcs/Carton)

石英熔金杯
Ceramic melting crucible

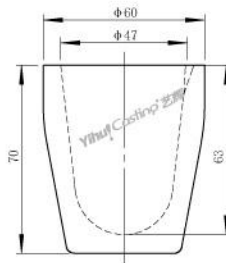

C500石英熔金杯

型号: C.CM.C0500
重量: 136g

C500 ceramic melting crucible

Model: C.CM.C0500
Weight: 136g

包装 Package: 450x300x240mm (105pcs/Carton)

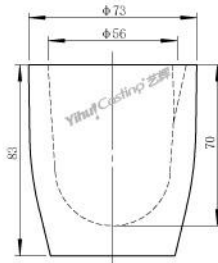

C750石英熔金杯

型号: C.CM.C0750
重量: 255g

C750 ceramic melting crucible

Model: C.CM.C0750
Weight: 255g

包装 Package: 450x300x240mm (48pcs/Carton)

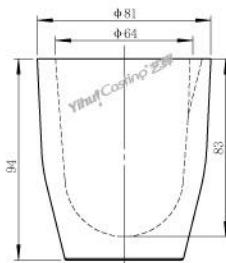

C1000石英熔金杯

型号: C.CM.C1000
重量: 320g

C1000 ceramic melting crucible

Model: C.CM.C1000
Weight: 320g

包装 Package: 450x300x240mm (36pcs/Carton)

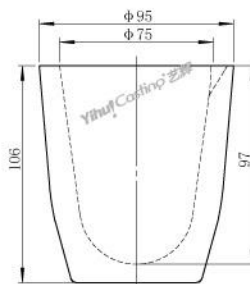

C2000石英熔金杯

型号: C.CM.C2000
重量: 447g

C2000 ceramic melting crucible

Model: C.CM.C2000
Weight: 447g

包装 Package: 450x300x240mm (30pcs/Carton)

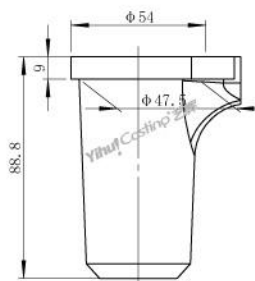

600克石英熔金杯

型号: C.CM.B0600
重量: 139g

600g ceramic melting crucible

Model: C.CM.B0600
Weight: 139g

包装 Package: 450x300x240mm (70pcs/Carton)

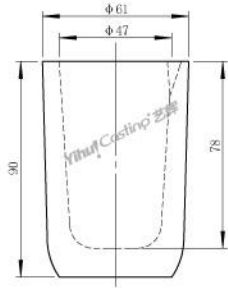

600g石英熔金杯
型号: C.CM.C0600
重量: 247g

600g ceramic melting crucible
Model: C.CM.C0600
Weight: 247g

包装 Package: 450x300x240mm (55pcs/Carton)

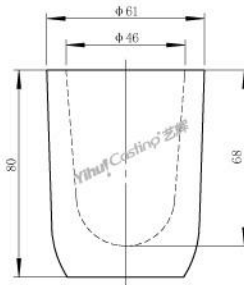

600g石英熔金杯
型号: C.CM.D0600
重量: 207g

600g ceramic melting crucible
Model: C.CM.D0600
Weight: 207g

包装 Package: 450x300x240mm (60pcs/Carton)

石英熔金杯
Ceramic melting crucible

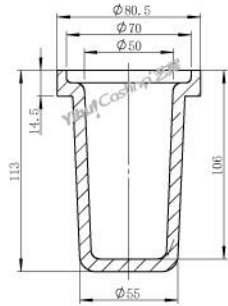

1000G石英熔金杯
型号: C.CM.1000G
重量: 250g

1000g ceramic melting crucible
Model: C.CM.1000G
Weight: 250g

包装 Package: 450x300x240mm (48pcs/Carton)

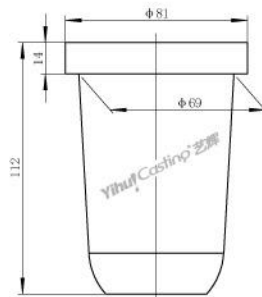

2000g石英熔金杯
型号: C.CM.2000G
重量: 395g

2000g ceramic melting crucible
Model: C.CM.2000G
Weight: 395g

包装 Package: 450x300x240mm (34pcs/Carton)

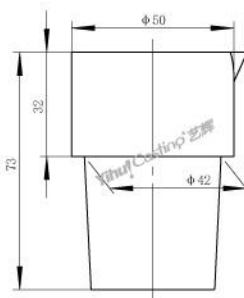

150g石英熔金杯
型号: C.CM.0150G
重量: 113g

150g ceramic melting crucible
Model: C.CM.0150G
Weight: 113g

包装 Package: 450x300x240mm (110pcs/Carton)

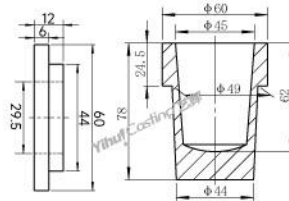

350石英熔金杯

型号: C.P.350WK

重量: 183g

350 ceramic melting crucible

Model: C.P.350WK

Weight: 183g

包装 Package: 450x300x240mm (70pcs/Carton)

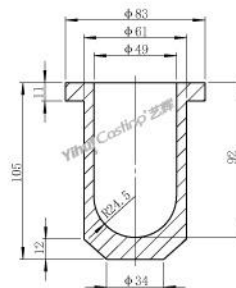

石英熔金杯

型号: C.CM.00001-PWBT

Weight: 263g

Ceramic melting crucible

Model: C.CM.00001-PWBT

Weight: 263g

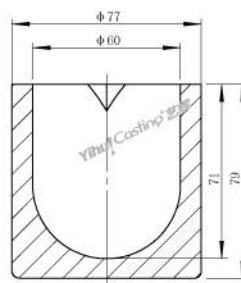

76-60石英熔金杯

型号: C.CM.B7660

重量: 330g

76-66 ceramic melting crucible

Model: C.CM.B7660

Weight: 330g

包装 Package: 450x300x240mm (36pcs/Carton)



石英碗
Ceramic bowl

名称 Description	型号 Model	尺寸 Size (mm)	重量 Weight (g)
2两石英碗 2 liang ceramic bowl	C.CM.00002	φ 56xH20	43
5两石英碗 5 liang ceramic bowl	C.CM.00005	φ 78xH36	93
10两石英碗 10 liang ceramic bowl	C.CM.00010	φ 89xH38	152
15两石英碗 15 liang ceramic bowl	C.CM.00015	φ 96xH41	192
20两石英碗 20 liang ceramic bowl	C.CM.00020	φ 105xH42	188
30两石英碗 30 liang ceramic bowl	C.CM.00030	φ 122xH53	282
50两石英碗 50 liang ceramic bowl	C.CM.00050	φ 140xH55	341
50两石英碗(新款) 50 liang ceramic bowl (New)	C.CM.0050D	φ 140xH57	309
100两石英碗 100 liang ceramic bowl	C.CM.00100	φ 170xH62	582
200两石英碗 200 liang ceramic bowl	C.CM.00200	φ 220xH70	1110
石英熔炼坩埚 Ceramic melting crucible	C.CM.30001	φ 60xH20	25
石英熔炼坩埚 Ceramic melting crucible	C.CM.30002	φ 74xH27	52
石英熔炼坩埚 Ceramic melting crucible	C.CM.30003	φ 94xH27	83
石英熔炼坩埚 Ceramic melting crucible	C.CM.30004	φ 111xH37	134

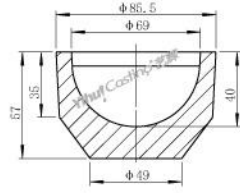

石英熔炼坩埚

型号: C.CM.086056
重量: 287g

Ceramic melting crucible

Model: C.CM.086056
Weight: 287g

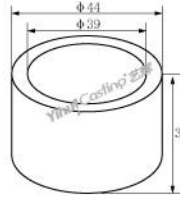

石英熔炼坩埚

型号: C.CM.00005-0SCT
重量: 70g

Ceramic melting crucible

Model: C.CM.00005-0SCT
Weight: 70g

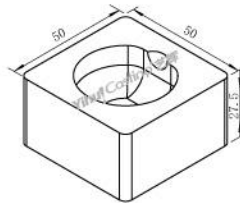

70#石英熔炼方坩埚

型号: C.CM.00070
重量: 98g

70# square shape ceramic melting crucible

Model: C.CM.00070
Weight: 98g

包装 Package: 450x300x240mm (228pcs/Carton)

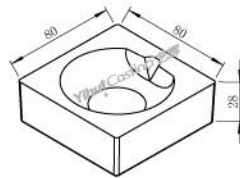

72#石英熔炼方坩埚

型号: C.CM.00072
重量: 237g

72# square shape ceramic melting crucible

Model: C.CM.00072
Weight: 237g

包装 Package: 450x300x240mm (100pcs/Carton)

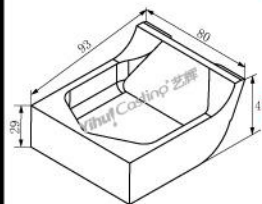
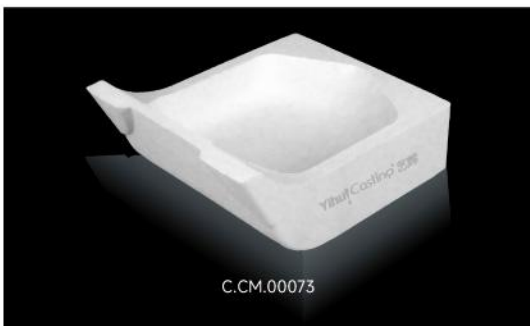

73#石英熔炼方坩埚

型号: C.CM.00073
重量: 222g

73# square shape ceramic melting crucible

Model: C.CM.00073
Weight: 222g

包装 Package: 450x300x240mm (72pcs/Carton)

石英熔炼坩埚
Ceramic melting crucible

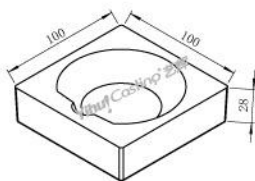

74#石英熔炼方坩埚

型号: C.CM.00074
重量: 346g

74# square shape ceramic melting crucible

Model: C.CM.00074
Weight: 346g

包装 Package: 450x300x240mm (72pcs/Carton)

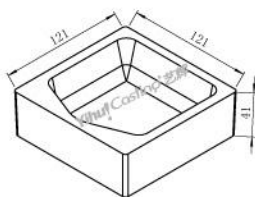

80#石英熔炼方坩埚

型号: C.CM.00080
重量: 621g

80# square shape ceramic melting crucible

Model: C.CM.00080
Weight: 621g

包装 Package: 450x300x240mm (32pcs/Carton)

石英熔炼坩埚
Ceramic melting crucible

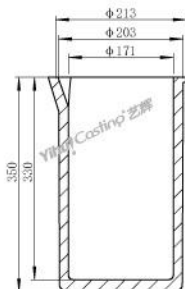

石英熔炼坩埚

型号: C.CM.210350
重量: 6450g

Ceramic melting crucible

Model: C.CM.210350
Weight: 6450g

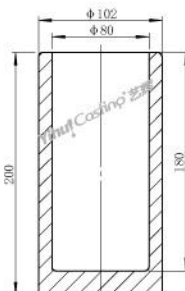

石英熔炼坩埚

型号: C.CM.100200
重量: 1412g

Ceramic melting crucible

Model: C.CM.100200
Weight: 1412g

包装 Package: 450x300x240mm (8pcs/Carton)

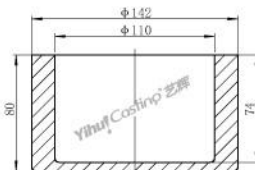

石英熔炼坩埚

型号: C.CM.141082
重量: 970g

Ceramic melting crucible

Model: C.CM.141082
Weight: 970g

包装 Package: 450x300x240mm (12pcs/Carton)

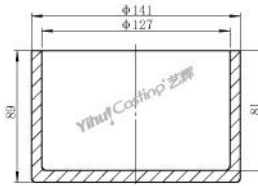

石英熔炼坩埚

型号: C.CM.140090
重量: 622g

Ceramic melting crucible

Model: C.CM.140090
Weight: 622g

包装 Package: 450x300x240mm (12pcs/Carton)

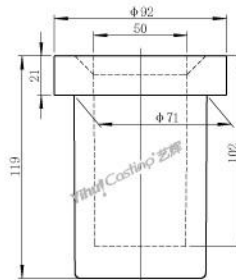

石英熔炼坩埚

型号: C.CM.00001-0JJW
重量: 774g

Ceramic melting crucible

Model: C.CM.00001-0JJW
Weight: 774g

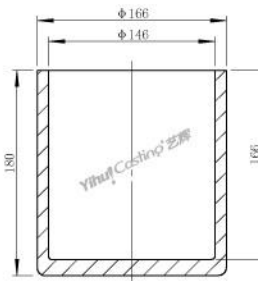

石英熔炼坩埚

型号: C.CM.00001-HZDX
重量: 1956g

Ceramic melting crucible

Model: C.CM.00001-HZDX
Weight: 1956g

包装 Package: 450x300x240mm (3pcs/Carton)

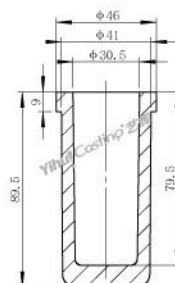

石英熔炼坩埚

型号: C.CM.00002-0SCT
重量: 113g

Ceramic melting crucible

Model: C.CM.00002-0SCT
Weight: 113g

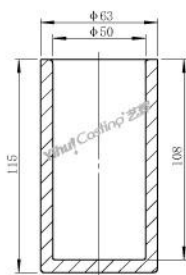

石英熔炼坩埚

型号: C.CM.00003-0SCT
重量: 268g

Ceramic melting crucible

Model: C.CM.00003-0SCT
Weight: 268g

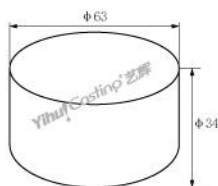

石英熔炼坩埚

型号: C.CM.00004-0SCT
重量: 188g

Ceramic melting crucible

Model: C.CM.00004-0SCT
Weight: 188g

石英熔炼坩埚
Ceramic melting crucible

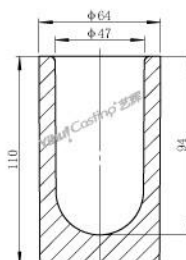

石英熔炼坩埚

型号: C.CM.00006-0SCT
重量: 344g

Ceramic melting crucible

Model: C.CM.00006-0SCT
Weight: 344g

包装 Package: 450x300x240mm (48pcs/Carton)



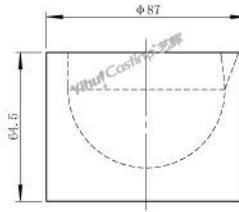

900C石英碗

型号: C.CM.0900C
重量: 416g

900C ceramic bowl

Model: C.CM.0900C
Weight: 416g

包装 Package: 450x300x240mm (36pcs/Carton)

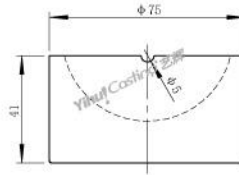

15C石英碗

型号: C.CM.0015C
重量: 250g

15C liang ceramic bowl

Model: C.CM.0015C
Weight: 250g

包装 Package: 450x300x240mm (85pcs/Carton)

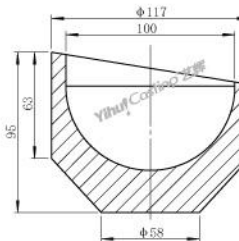

石英熔炼坩埚

型号: C.CM.119096
重量: 715g

Ceramic melting crucible

Model: C.CM.119096
Weight: 715g

包装 Package: 450x300x240mm (24pcs/Carton)

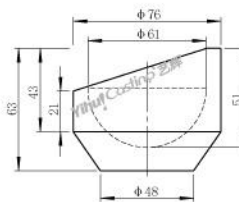

石英熔炼坩埚

型号: C.CM.080064
重量: 215g

Ceramic melting crucible

Model: C.CM.080064
Weight: 215g

包装 Package: 450x300x240mm (60pcs/Carton)



450Y石英铸造坩埚

型号: C.CP.0450Y
重量: 412g

450Y ceramic casting crucible

Model: C.CP.0450Y
Weight: 412g

包装 Package: 450x300x240mm (30pcs/Carton)

石英熔炼坩埚
Ceramic melting crucible

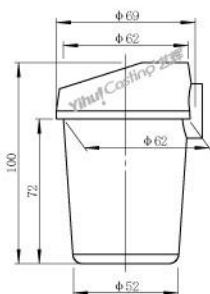

400Y-A石英铸造坩埚

型号: C.CP.0400Y-A
重量: 258g

400Y-A ceramic casting crucible

Model: C.CP.0400Y-A
Weight: 258g

包装 Package: 450x300x240mm (48pcs/Carton)

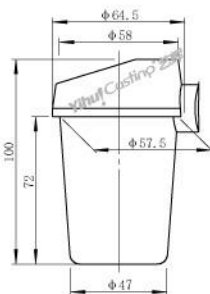

400Y石英铸造坩埚

型号: C.CP.0400Y
重量: 257g

400Y ceramic casting crucible

Model: C.CP.0400Y
Weight: 257g

包装 Package: 450x300x240mm (48pcs/Carton)

石英铸造坩埚
Ceramic casting crucible

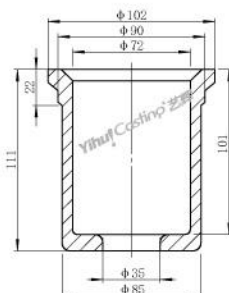

石英铸造坩埚

型号: C.CP.K0050
重量: 408g

Ceramic casting crucible

Model: C.CP.K0050
Weight: 408g

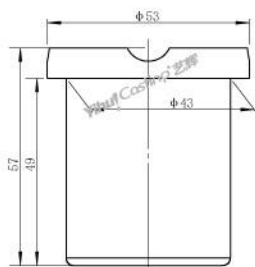

石英铸造坩埚

型号: C.CP.JT150-1
重量: 112g

Ceramic casting crucible

Model: C.CP.JT150-1
Weight: 112g

包装 Package: 450x300x240mm (162pcs/Carton)

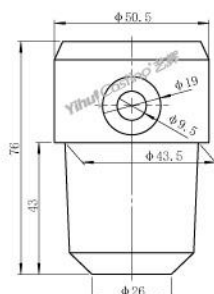

150D石英铸造坩埚

型号: C.CP.0150D
重量: 117g

150D ceramic casting crucible

Model: C.CP.0150D
Weight: 117g

包装 Package: 450x300x240mm (96pcs/Carton)



C.CP.0150A

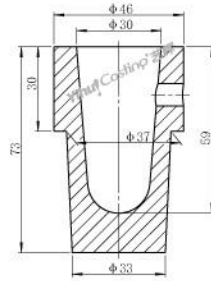

150A石英铸造坩埚

型号: C.CP.0150A
重量: 115g

150A ceramic casting crucible

Model: C.CP.0150A
Weight: 115g

包装 Package: 450x300x240mm (120pcs/Carton)



C.CP.2000B

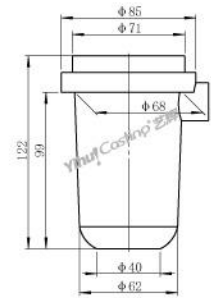

2公斤石英铸造坩埚

型号: C.CP.2000B
重量: 350g

2kg ceramic casting crucible

Model: C.CP.2000B
Weight: 350g

包装 Package: 450x300x240mm (25pcs/Carton)



C.CP.0250B-1

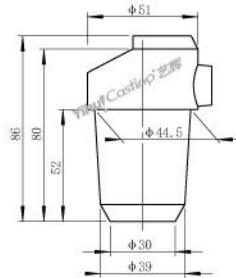

250B-1石英铸造坩埚

型号: C.CP.0250B-1
重量: 134g

250B-1 ceramic casting crucible

Model: C.CP.0250B-1
Weight: 134g



C.CP.1200B

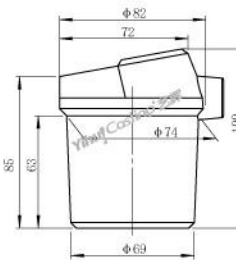

1200B石英铸造坩埚

型号: C.CP.1200B
重量: 385g

1200B ceramic casting crucible

Model: C.CP.1200B
Weight: 385g

包装 Package: 450x300x240mm (28pcs/Carton)



C.CP.052042083



250H石英铸造坩埚

型号: C.CP.052042083
重量: 121g

250H ceramic casting crucible

Model: C.CP.052042083
Weight: 121g

包装 Package: 450x300x240mm (53pcs/Carton)

石英铸造坩埚
Ceramic casting crucible

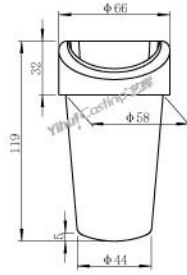

350H石英铸造坩埚

型号: C.P.055117
重量: 192g

350H ceramic casting crucible

Model: C.P.055117
Weight: 192g

包装 Package: 450x300x240mm (48pcs/Carton)

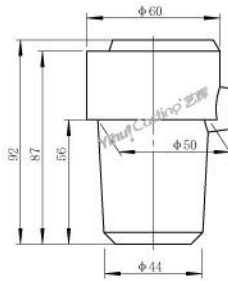

350A石英铸造坩埚

型号: C.P.0350A
重量: 210g

350A Ceramic casting crucible

Model: C.P.0350A
Weight: 210g

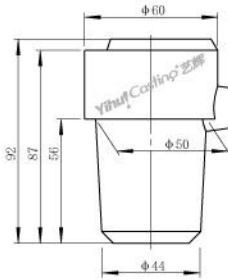

350A-1石英铸造坩埚

型号: C.P.0350A-1
重量: 221g

350A-1 Ceramic casting crucible

Model: C.P.0350A-1
Weight: 221g

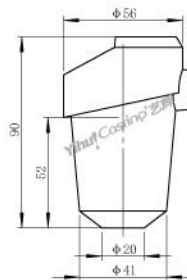

350D石英铸造坩埚

型号: C.P.0350D
重量: 158g

350D Ceramic casting crucible

Model: C.P.0350D
Weight: 158g

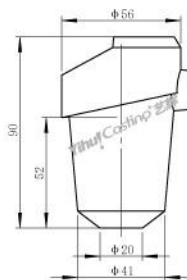

350D-2石英铸造坩埚

型号: C.P.0350D-2
重量: 160g

350D-2 Ceramic casting crucible

Model: C.P.0350D-2
Weight: 160g

包装 Package: 450x300x240mm (92pcs/Carton)

石英铸造坩埚
Ceramic casting crucible

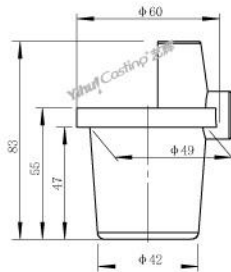

250l石英铸造坩埚

型号: C.CP.060083
重量: 100g

250l ceramic casting crucible

Model: C.CP.060083
Weight: 100g

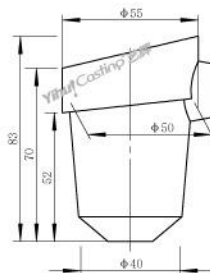

350F石英铸造坩埚

型号: C.CP.055085
重量: 106g

350F ceramic casting crucible

Model: C.CP.055085
Weight: 106g



2公斤石英撒珠坩埚

型号: C.GC.00020
重量: 384g

2KG ceramic granulating crucible

Model: C.GC.00020
Weight: 384g

包装 Package: 450x300x240mm (46pcs/Carton)

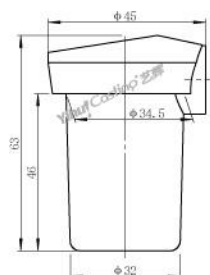

150H石英铸造坩埚

型号: C.CP.044063
重量: 59g

150H ceramic casting crucible

Model: C.CP.044063
Weight: 59g

包装 Package: 450x300x240mm (230pcs/Carton)



C.P.250C

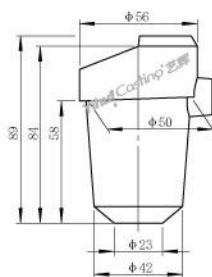

250C石英铸造坩埚

型号: C.CP.0250C

重量: 174g

250C ceramic casting crucible

Model: C.CP.0250C

Weight: 174g

包装 Package: 450x300x240mm (92pcs/Carton)



C.P.052083

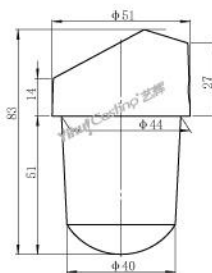

250F石英铸造坩埚

型号: C.CP.052083

重量: 107g

250F ceramic casting crucible

Model: C.CP.052083

Weight: 107g

包装 Package: 450x300x240mm (47pcs/Carton)



C.CC.093103

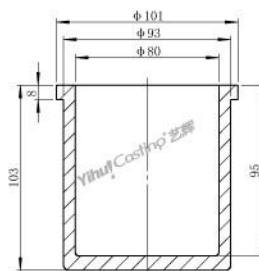

石英熔炼坩埚

型号: C.CC.093103

重量: 395g

Ceramic melting crucible

Model: C.CC.093103

Weight: 395g



C.CC.1000A

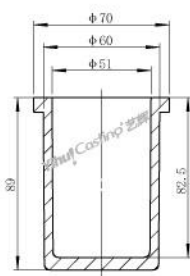

1公斤石英外套

型号: C.CC.1000A

重量: 153g

1kg ceramic shielded

Model: C.CC.1000A

Weight: 153g

包装 Package: 450x300x240mm (72pcs/Carton)



C.CC.2000A

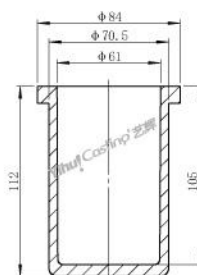

2公斤石英外套

型号: C.CC.2000A

重量: 265g

2kg ceramic shielded

Model: C.CC.2000A

Weight: 265g

包装 Package: 450x300x240mm (30pcs/Carton)

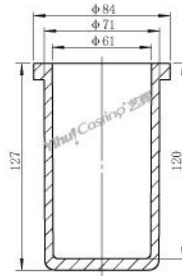

2.5公斤石英外套-A

型号: C.CC.2500A
重量: 292g

2.5kg ceramic shield-A

Model: C.CC.2500A
Weight: 292g

包装 Package: 420x315x348mm (40pcs/Carton)

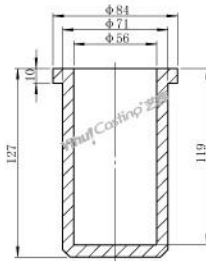

2.5公斤石英外套-F

型号: C.CC.2500F
重量: 292g

2.5kg ceramic shield-F

Model: C.CC.2500F
Weight: 292g

包装 Package: 420x315x348mm (40pcs/Carton)

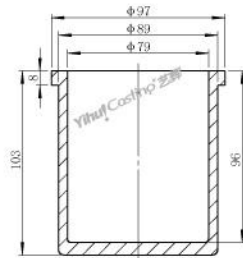

3公斤石英外套-A

型号: C.CC.3000A
重量: 324g

3kg ceramic shield-A

Model: C.CC.3000A
Weight: 324g

包装 Package: 420x315x348mm (36pcs/Carton)

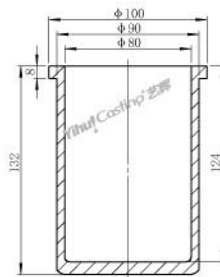

4公斤石英外套-A

型号: C.CC.4000A
重量: 392g

4kg ceramic shield-A

Model: C.CC.4000A
Weight: 392g

包装 Package: 420x315x348mm (24pcs/Carton)

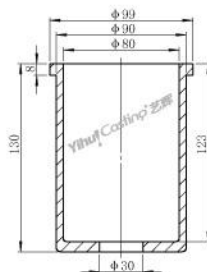

4公斤石英外套 (底孔30mm)

型号: C.CC.4000A-30
重量: 378g

4kg ceramic shield (Bottom hole 30mm)

Model: C.CC.4000A-30
Weight: 378g

包装 Package: 420x315x348mm (24pcs/Carton)

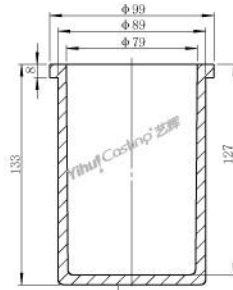

4公斤石英外套-B

型号: C.CC.4000B
重量: 474g

4kg ceramic shield-B

Model: C.CC.4000B
Weight: 474g

包装 Package: 420x315x348mm (24pcs/Carton)

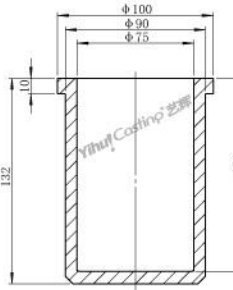

4公斤石英外套-F

型号: C.CC.4000F
重量: 378g

4kg ceramic shield-F

Model: C.CC.4000F
Weight: 378g

包装 Package: 420x315x348mm (24pcs/Carton)

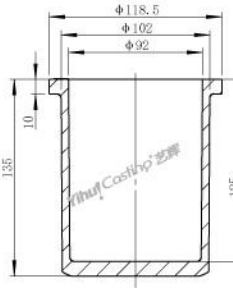

5公斤石英外套-A

型号: C.CC.5000A
重量: 693g

5kg ceramic shield-A

Model: C.CC.5000A
Weight: 693g

包装 Package: 420x315x348mm (18pcs/Carton)

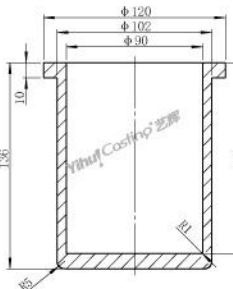

5公斤石英外套-C

型号: C.CC.5000C
重量: 617g

5kg ceramic shield-C

Model: C.CC.5000C
Weight: 617g

包装 Package: 420x315x348mm (18pcs/Carton)

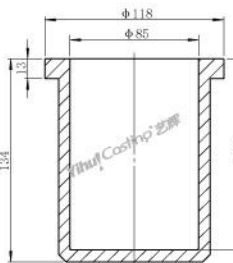

5公斤石英外套-F

型号: C.CC.5000F
重量: 645g

5kg ceramic shield-F

Model: C.CC.5000F
Weight: 645g

包装 Package: 420x315x348mm (16pcs/Carton)

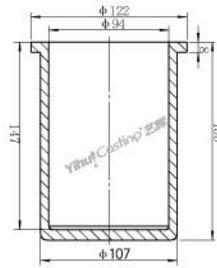

5.5公斤石英外套-A

型号: C.CC.5500A
重量: 693g

5.5kg ceramic shield-A

Model: C.CC.5500A
Weight: 693g

包装 Package: 420x315x348mm (16pcs/Carton)

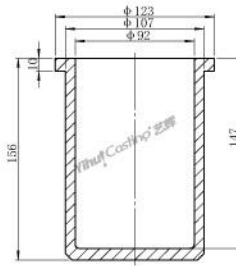

5.5公斤石英外套-F

型号: C.CC.5500F
重量: 693g

5.5kg ceramic shield-F

Model: C.CC.5500F
Weight: 693g

包装 Package: 420x315x348mm (16pcs/Carton)

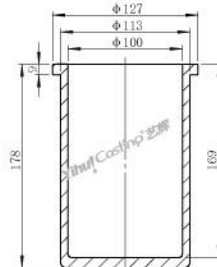

6公斤石英外套-A

型号: C.CC.6000A
重量: 822g

6kg ceramic shield-A

Model: C.CC.6000A
Weight: 822g

包装 Package: 420x315x348mm (12pcs/Carton)

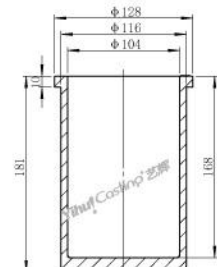

6公斤石英外套-B

型号: C.CC.6000B
重量: 867g

6kg ceramic shield-B

Model: C.CC.6000B
Weight: 867g

包装 Package: 420x315x348mm (12pcs/Carton)

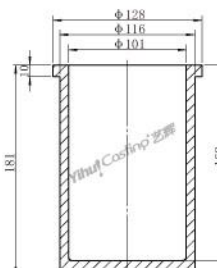

6公斤石英外套-F

型号: C.CC.6000F
重量: 867g

6kg ceramic shield-F

Model: C.CC.6000F
Weight: 867g

包装 Package: 420x315x348mm (12pcs/Carton)

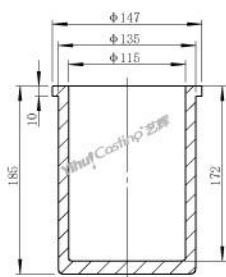

8公斤石英外套-A

型号: C.C.8000A

重量: 1448g

8kg ceramic shield-A

Model: C.C.8000A

Weight: 1448g

包装 Package: 420x315x348mm (10pcs/Carton)

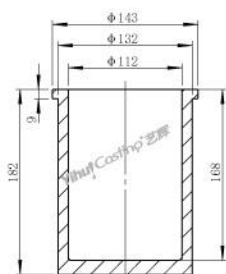

8公斤石英外套-B

型号: C.C.8000B

重量: 1538g

8kg ceramic shield-B

Model: C.C.8000B

Weight: 1538g

包装 Package: 420x315x348mm (10pcs/Carton)

石英外套
Ceramic shield

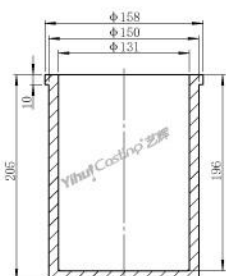

12公斤石英外套

型号: C.C.12000

重量: 1600g

12kg ceramic shield

Model: C.C.12000

Weight: 1600g

包装 Package: 450x300x240mm (4pcs/Carton)



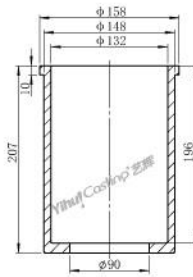

12公斤石英外套 (底孔90mm)

型号: C.C.C.12000-90
重量: 1510g

12kg ceramic shield (Bottom hole 90mm)

Model: C.C.C.12000-90
Weight: 1510g

包装 Package: 450x300x240mm (4pcs/Carton)

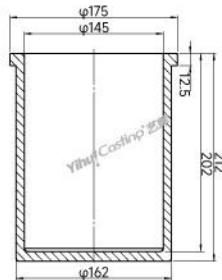

16公斤石英外套

型号: C.C.C.16000
重量: 1950g

16kg ceramic shield

Model: C.C.C.16000
Weight: 1950g

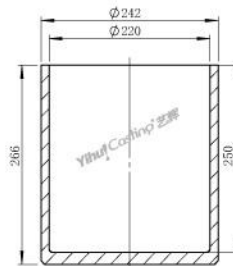

30公斤石英外套

型号: C.C.C.30000-N
重量: 4750g

30kg ceramic shield

Model: C.C.C.30000-N
Weight: 4750g

包装 Package: 450x300x240mm (1pcs/Carton)

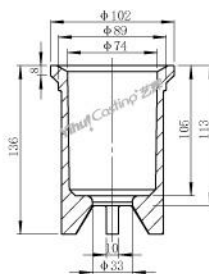

K2/KT17石英外套

型号: C.C.C.K0010
重量: 390g

K2/KT17 ceramic shield

Model: C.C.C.K0010
Weight: 390g

包装 Package: 420x315x348mm (24pcs/Carton)

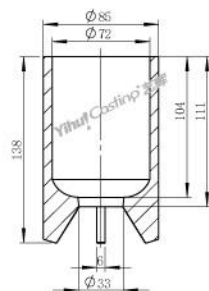

无边K2/KT17石英外套

型号: C.C.C.K001A
重量: 325g

K2/KT17 ceramic shield

Model: C.C.C.K001A
Weight: 325g

石英外套
Ceramic shield

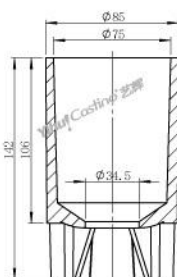

宽脚无边K2/KT17石英外套

型号: C.C.C.K001B
重量: 407g

K2/KT17 ceramic shield

Model: C.C.C.K001B
Weight: 407g

包装 Package: 420x315x348mm (24pcs/Carton)



K2/KT17石英外套盖

型号: C.C.C.K0010-A
重量: 215g

K2/KT17 ceramic shielded cover

Model: C.C.C.K0010-A
Weight: 215g

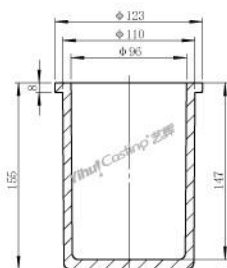

石英外套

型号: C.C.C.122155
重量: 751g

Ceramic shielded

Model: C.C.C.122155
Weight: 751g

包装 Package: 420x315x348mm (16pcs/Carton)

石英外套
Ceramic shield

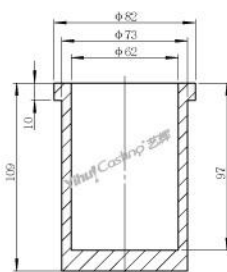

082109石英外套

型号: C.C.C.082109
重量: 313g

082109 ceramic shielded

Model: C.C.C.082109
Weight: 313g

包装 Package: 450x300x240mm (36pcs/Carton)

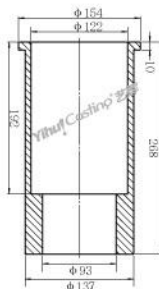

152265石英外套

型号: C.C.C.152265
重量: 2200g

152265 ceramic shield

Model: C.C.C.152265
Weight: 2200g

包装 Package: 420x315x348mm (5pcs/Carton)

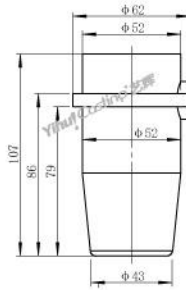

C40石英外套

型号: C.CC.00040
重量: 720g

C40 ceramic shiled

Model: C.CC.00040
Weight: 720g

包装 Package: 450x300x240mm (70pcs/Carton)

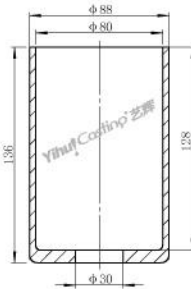

AVC铸造机石英外套

型号: C.CC.AVC
重量: 317g

AVC casting machine ceramic shiled

Model: C.CC.AVC
Weight: 317g

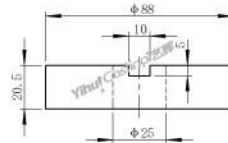

AVC-B铸造机石英外套

型号: C.CC.AVC-B
重量: 193g

AVC-B casting machine ceramic shiled

Model: C.CC.AVC-B
Weight: 193g

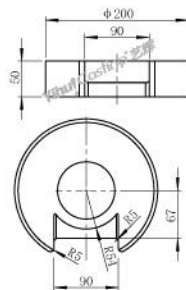

AVC-D投料盖

型号: C.CC.AVC-D
重量: 1369g

AVC-D coverp

Model: C.CC.AVC-D
Weight: 1369g

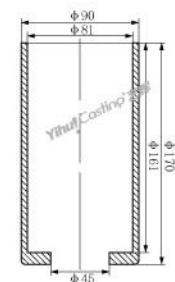

3公斤连续铸造机石英外套

型号: C.CC.L3000B
重量: 393g

3kg continuous casting machine ceramic shield

Model: C.CC.L3000B
Weight: 393g

包装 Package: 420x315x348mm (12pcs/Carton)

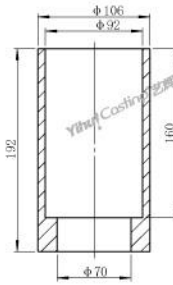

5公斤连续铸造机石英外套

型号: C.CC.L5000-A
重量: 900g

5kg continuous casting machine ceramic shield

Model: C.CC.L5000-A
Weight: 900g

包装 Package: 450x300x240mm (6pcs/Carton)

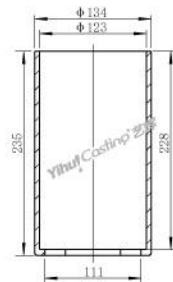

8公斤连续铸造机石英外套

型号: C.CC.L8000
重量: 922g

8kg continuous casting machine ceramic shield

Model: C.CC.L8000
Weight: 922g

包装 Package: 420x315x348mm (6pcs/Carton)

石英外套
Ceramic shield

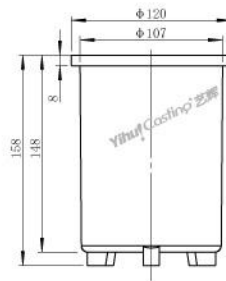

铸造机石英外套

型号: C.CC.SZJ02
重量: 630g

Casting machine ceramic shield

Model: C.CC.SZJ02
Weight: 630g

包装 Package: 420x315x348mm (16pcs/Carton)

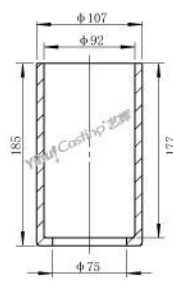

105184石英外套

型号: C.CC.105184
重量: 730g

105184 ceramic shield

Model: C.CC.105184
Weight: 730g

包装 Package: 420x315x348mm (15pcs/Carton)



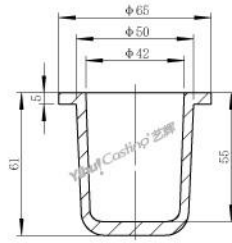

065062石英外套
 型号: C.CC.065062
 重量: 81g

065062 ceramic shielded
 Model: C.CC.065062
 Weight: 81g

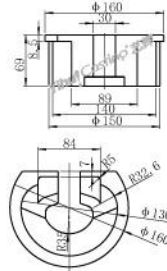

VPC偏嘴坩石英外套上盖
 型号: C.CC.V0030-A
 重量: 944g

Ceramic cover for VPC ceramic shield
 Model: C.CC.V0030-A
 Weight: 944g

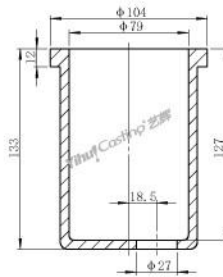

VPC偏嘴坩石英外套
 型号: C.CC.V0016
 重量: 459g

VPC ceramic shield
 Model: C.CC.V0016
 Weight: 459g

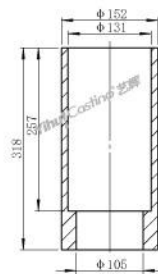

石英外套
 型号: C.CC.00001-DIST
 重量: 2300g

Ceramic shielded
 Model: C.CC.00001-DIST
 Weight: 2300g

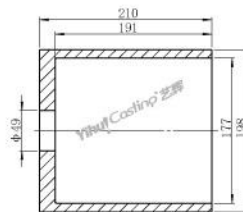

跑道场石英外套
 型号: C.CC.PDC01
 重量: 2300g

Ceramic shield
 Model: C.CC.PDC01
 Weight: 2300g

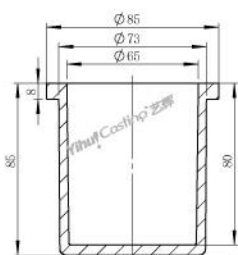

石英外套

型号: C.CC.1250A
重量: 182g

Ceramic shielded

Model: C.CC.1250A
Weight: 182g

包装 Package: 420x315x348mm (48pcs/Carton)

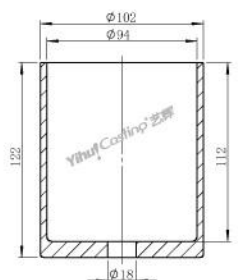

石英外套 (底孔18mm)

型号: C.CC.10018
重量: 428g

Ceramic shielded (Bottom hole 18mm)

Model: C.CC.10018
Weight: 428g

包装 Package: 420x315x348mm (20pcs/Carton)

石英外套
Ceramic shield

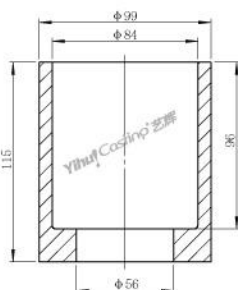

石英外套

型号: C.CC.00001-0JZF
重量: 502g

Ceramic shield

Model: C.CC.00001-0JZF
Weight: 502g

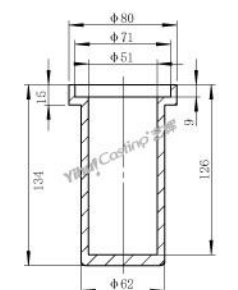

石英外套

型号: C.CC.00682-0WRT
重量: 258g

Ceramic shield

Model: C.CC.00682-0WRT
Weight: 258g

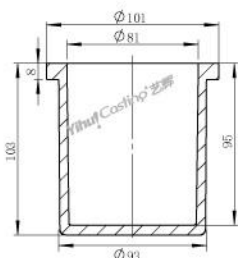

石英外套

型号: C.CC.00001-PROM
重量: 427g

Ceramic shielded

Model: C.CC.00001-PROM
Weight: 427g



C.CC.00001-FATH

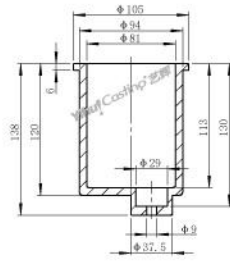

石英外套

型号: C.CC.00001-FATH
重量: 440g

Ceramic shielded

Model: C.CC.00001-FATH
Weight: 440g



C.CC.00350-A

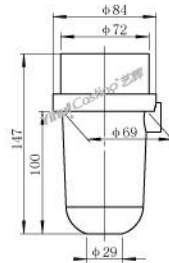

C350石英外套带盖

型号: C.CC.00350-A
重量: 334g

C350 ceramic shield with cover

Model: C.CC.00350-A
Weight: 334g

包装 Package: 420x315x348mm (30pcs/Carton)



C.CC.665620

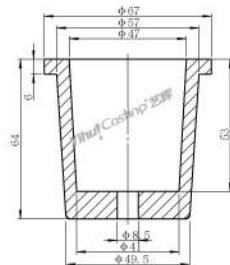

665620石英外套

型号: C.CC.665620
重量: 119g

665620 ceramic shielded

Model: C.CC.665620
Weight: 119g



C.CC.122155-15

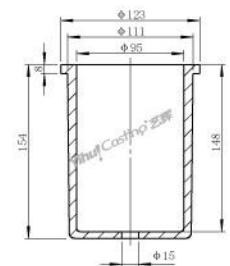

石英外套 (底孔15mm)

型号: C.CC.122155-15
重量: 748g

Ceramic shielded (Bottom hole 15mm)

Model: C.CC.122155-15
Weight: 748g

包装 Package: 420x315x348mm (16pcs/Carton)



C.CC.K0015

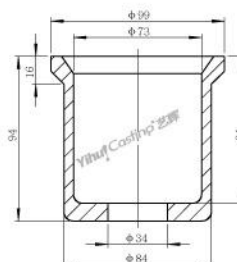

K15石英外套

型号: C.CC.K0015
重量: 305g

K15 ceramic shielded

Model: C.CC.K0015
Weight: 305g

包装 Package: 420x315x348mm (36pcs/Carton)

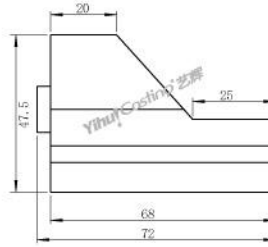

3安士石英船坩

型号: C.CB.0003B
重量: 90g

3 ounce ceramic boat

Model: C.CB.0003B
Weight: 90g

包装 Package: 450x300x240mm (101pcs/Carton)

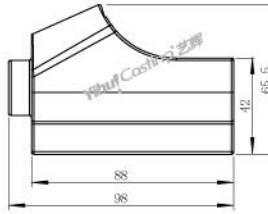

5安士石英船坩A

型号: C.CB.0005A
重量: 269g

5 ounce ceramic boat A

Model: C.CB.0005A
Weight: 269g

包装 Package: 450x300x240mm (63pcs/Carton)

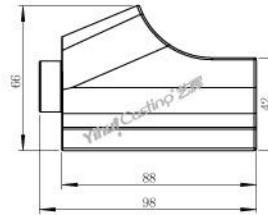

5安士石英船坩B

型号: C.CB.0005B
重量: 293g

5 ounce ceramic boat B

Model: C.CB.0005B
Weight: 293g

包装 Package: 450x300x240mm (63pcs/Carton)

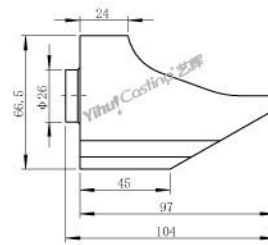

8安士石英船坩

型号: C.CB.0008A
重量: 246g

8 ounce ceramic boat

Model: C.CB.0008A
Weight: 246g

包装 Package: 450x300x240mm (60pcs/Carton)

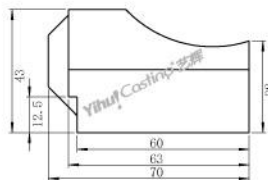

10安士石英船坩

型号: C.CB.00010
重量: 141g

10 ounce ceramic boat

Model: C.CB.00010
Weight: 141g

包装 Package: 450x300x240mm (136pcs/Carton)

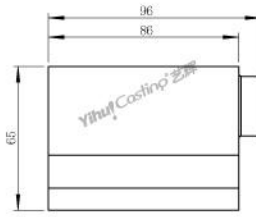

燕尾25安士船坩
 型号: C.CB.00025
 重量: 667g

25 ounce ceramic boat
 Model: C.CB.00025
 Weight: 667g

包装 Package: 450x300x240mm (42pcs/Carton)

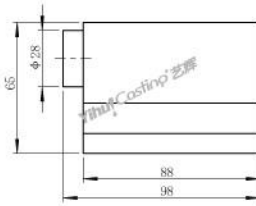

平尾25安士船坩
 型号: C.CB.0025C
 重量: 443g

25 ounce ceramic boat
 Model: C.CB.0025C
 Weight: 443g

包装 Package: 450x300x240mm (42pcs/Carton)

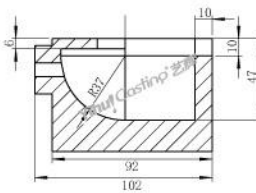

30安士石英船坩
 型号: C.CB.00030
 重量: 540g

30 ounce ceramic boat
 Model: C.CB.00030
 Weight: 540g

包装 Package: 450x300x240mm (30pcs/Carton)

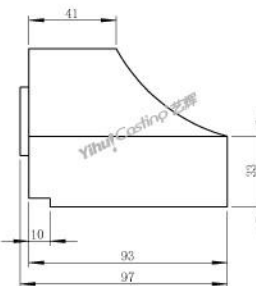

30安士石英船坩B
 型号: C.CB.0030B
 重量: 486g

30 ounce ceramic boat B
 Model: C.CB.0030B
 Weight: 486g

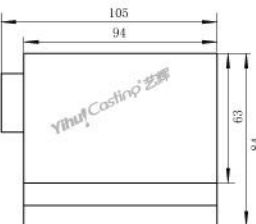

40安士石英船坩
 型号: C.CB.00040
 重量: 668g

40 ounce ceramic boat
 Model: C.CB.00040
 Weight: 668g

包装 Package: 450x300x240mm (22pcs/Carton)

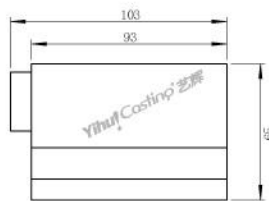

50安士石英船坩

型号: C.CB.00050
重量: 511g

50 ounce ceramic boat

Model: C.CB.00050
Weight: 511g

包装 Package: 450x300x240mm (32pcs/Carton)

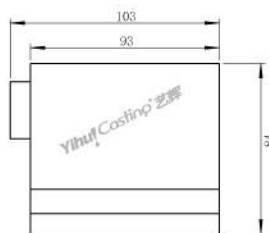
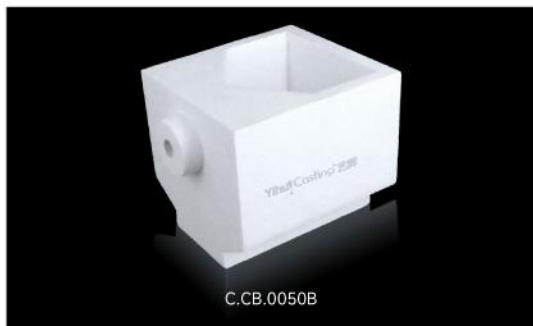

50安士石英船坩B

型号: C.CB.0050B
重量: 644g

50 ounce ceramic boat B

Model: C.CB.0050B
Weight: 644g

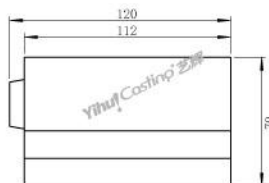

75安士石英船坩

型号: C.CB.00075
重量: 770g

75 ounce ceramic boat

Model: C.CB.00075
Weight: 770g

包装 Package: 420x315x348mm (30pcs/Carton)

石英船坩
Ceramic boat

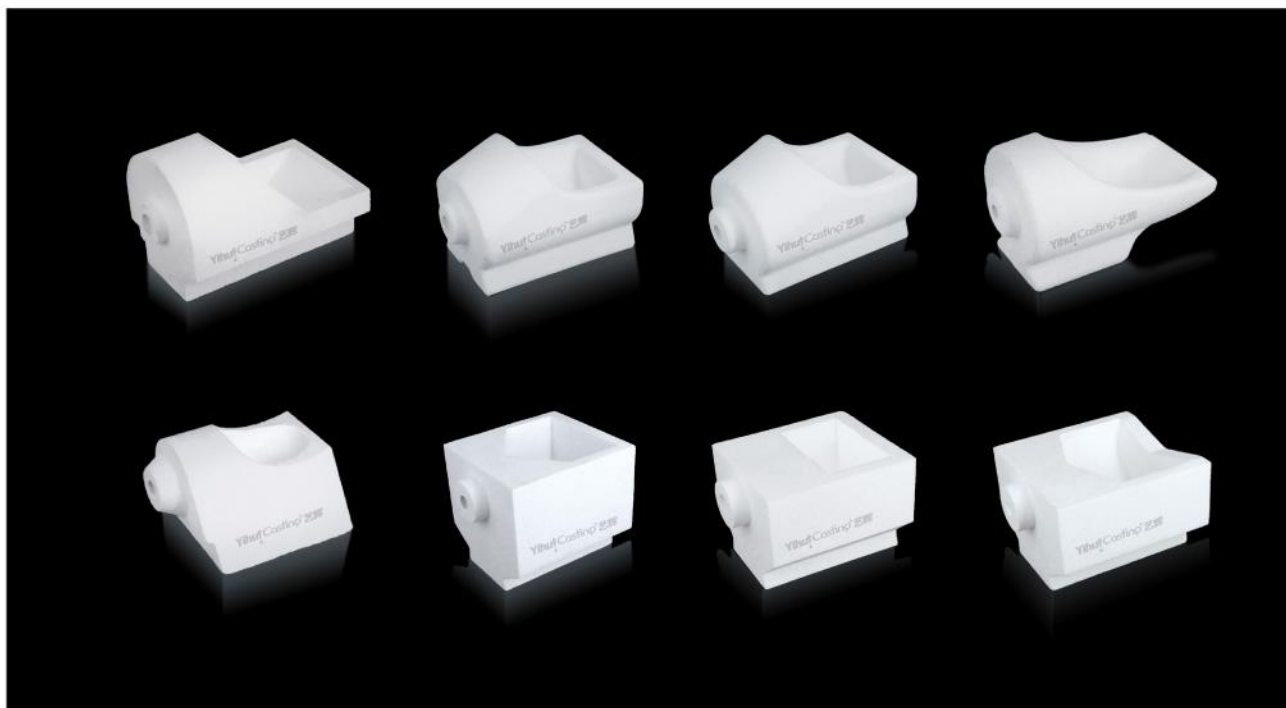



C.S.00001

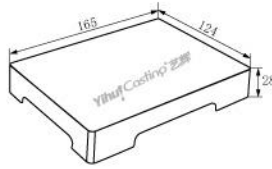

4脚石英焊板

型号: C.S.00001
重量: 357g

Ceramic soldering plate with 4 feet

Model: C.S.00001
Weight: 357g

包装 Package: 450x300x240mm (30pcs/Carton)



C.S.00002



6脚石英焊板

型号: C.S.00002
重量: 860g

Ceramic soldering plate with 6 feet

Model: C.S.00002
Weight: 860g

包装 Package: 420x315x348mm (35pcs/Carton)

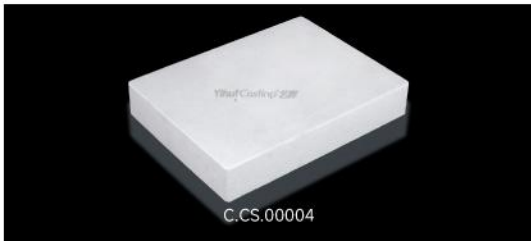

C.S.00004

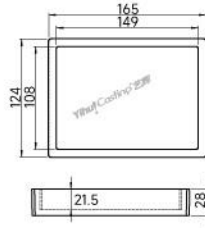

平脚石英焊板

型号: C.S.00004
重量: 402g

Flat ceramic soldering plate

Model: C.S.00004
Weight: 402g

包装 Package: 420x315x348mm (48pcs/Carton)



C.S.00005

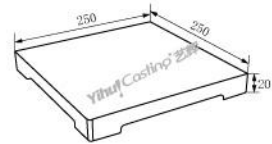

石英焊板

型号: C.S.00005
重量: 1472g

Ceramic soldering plate

Model: C.S.00005
Weight: 1472g

包装 Package: 420x315x348mm (12pcs/Carton)



C.S.00006



长石英焊板

型号: C.S.00006
重量: 764g

Long ceramic soldering plate

Model: C.S.00006
Weight: 764g



C.S.00015

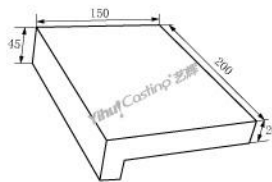

石英焊板

型号: C.S.00015
重量: 1473g

Ceramic soldering plate

Model: C.S.00015
Weight: 1473g

包装 Package: 420x315x348mm (26pcs/Carton)



C.S.00016

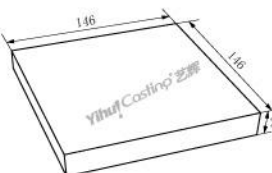

石英盖板

型号: C.S.00016
重量: 735g

Ceramic cover plate

Model: C.S.00016
Weight: 735g



石英环

型号: C.CH.113080013

重量: 112g

Ceramic ring

Model: C.CH.113080013

Weight: 112g

包装 Package: 450x300x240mm (57pcs/Carton)



石英环

型号: C.CH.123086021

重量: 229g

Ceramic ring

Model: C.CH.123086021

Weight: 229g

包装 Package: 450x300x240mm (57pcs/Carton)



石英环

型号: C.CH.195175060

重量: 646g

Ceramic ring

Model: C.CH.195175060

Weight: 646g



石英环

型号: C.CH.093059013

重量: 91g

Ceramic ring

Model: C.CH.093059013

Weight: 91g



石英环

型号: C.CH.087055013

重量: 80g

Ceramic ring

Model: C.CH.087055013

Weight: 80g



石英环

型号: C.CH.078048025

重量: 35g

Ceramic ring

Model: C.CH.078048025

Weight: 35g



C.CK.040079

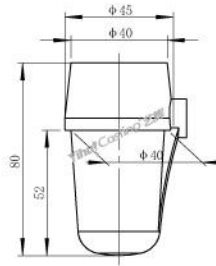

石英齿科坩埚

型号: C.CK.040079

重量: 69g

Ceramic Dental Crucible

Model: C.CK.040079

Weight: 69g



C.CK.037071-A

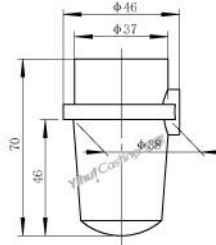

石英齿科坩埚

型号: C.CK.037071-A

重量: 64g

Ceramic Dental Crucible

Model: C.CK.037071-A

Weight: 64g



C.CK.038075-A

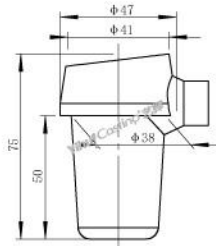

石英齿科坩埚

型号: C.CK.038075-A

重量: 61g

Ceramic Dental Crucible

Model: C.CK.038075-A

Weight: 61g



C.CK.035061-A

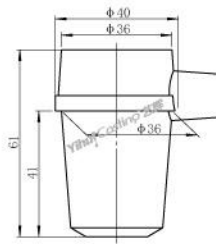

石英齿科坩埚

型号: C.CK.035061-A

重量: 48g

Ceramic Dental Crucible

Model: C.CK.035061-A

Weight: 48g



C.CK.035061-B

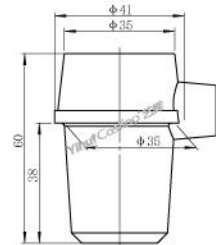

石英齿科坩埚

型号: C.CK.035061-B

重量: 54g

Ceramic Dental Crucible

Model: C.CK.035061-B

Weight: 54g



C.CP.YK-F1

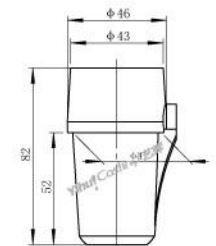

石英齿科坩埚

型号: C.CP.YK-F1

重量: 79g

Ceramic Dental Crucible

Model: C.CP.YK-F1

Weight: 79g

包装 Package: 450x300x240mm (120pcs/Carton)



C.CA.00007

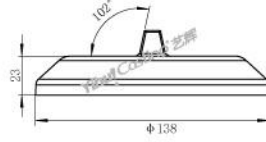

铸造机石英配件

型号: C.CA.00007
重量: 252g

Ceramic parts for casting machine

Model: C.CA.00007
Weight: 252g

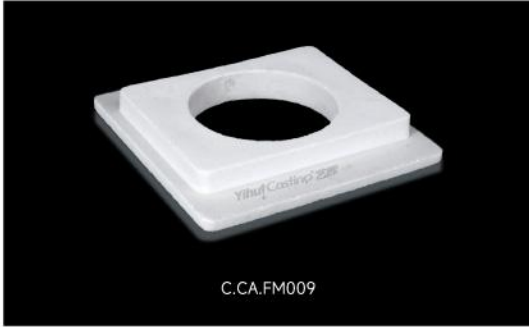

C.CA.FM009

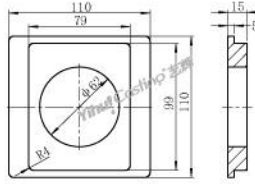

小法兰

型号: C.CA.FM009
重量: 171g

Small flange

Model: C.CA.FM009
Weight: 171g

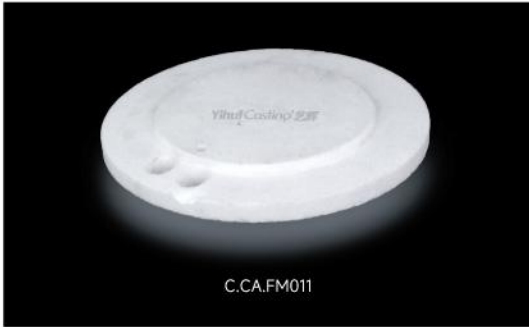

C.CA.FM011

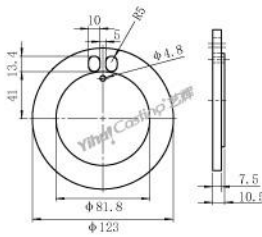

石英炉胆底托

型号: C.CA.FM011
重量: 183g

Ceramic chamber base

Model: C.CA.FM011
Weight: 183g

包装 Package: 420x315x348mm (12pcs/Carton)



C.CA.FM012

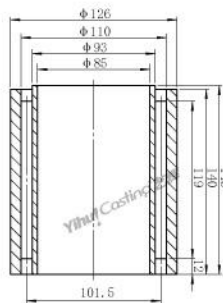

石英新炉胆

型号: C.CA.FM012
重量: 1430g

New ceramic chamber base

Model: C.CA.FM012
Weight: 1430g

包装 Package: 420x315x348mm (12pcs/Carton)



C.CA.01055

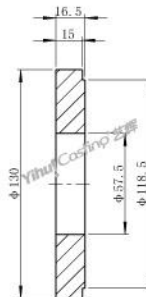

1公斤/2公斤石英法兰

型号: C.CA.01055
重量: 309g

1kg/2kg ceramic flange

Model: C.CA.01055
Weight: 309g

包装 Package: 420x315x348mm (90pcs/Carton)

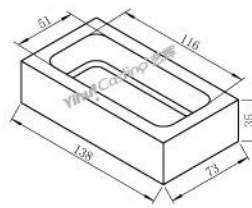

石英槽

型号: C.CI.114080025
重量: 362g

Ceramic groove

Model: C.CI.114080025
Weight: 362g

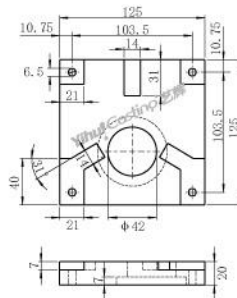

铸造机石英底座

型号: C.CD.SZJ02
重量: 440g

Ceramic base for casting machine

Model: C.CD.SZJ02
Weight: 440g

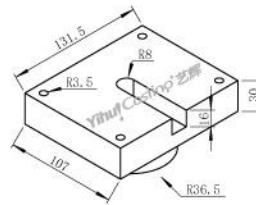

铸造机石英底座

型号: C.CD.SZJ03
重量: 872g

Ceramic base for casting machine

Model: C.CD.SZJ03
Weight: 872g

包装 Package: 450x300x240mm (24pcs/Carton)

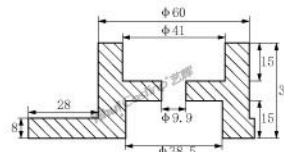

石英底座

型号: C.CD.00001-FATH
重量: 168g

Ceramic base

Model: C.CD.00001-FATH
Weight: 168g

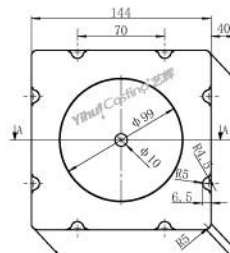

方炉盖

型号: C.CA.FM010
重量: 1042g

Square lid

Model: C.CA.FM010
Weight: 1042g

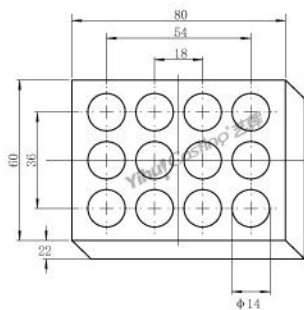

石英配件

型号: C.CA.00011
重量: 177g

Ceramic parts

Model: C.CA.00011
Weight: 177g

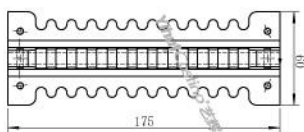

石英发热芯

型号: C.CA.175060
重量: 326g

Ceramic heater

Model: C.CA.175060
Weight: 326g

包装 Package: 420x315x348mm (52pcs/Carton)

石英配件
Ceramic parts

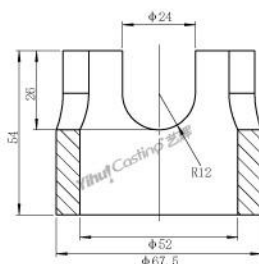

石英配件

型号: C.CA.00012
重量: 111g

Ceramic parts

Model: C.CA.00012
Weight: 111g

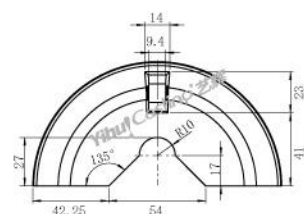

石英前盖

型号: C.CA.00008-A
重量: 136g

Ceramic front cover

Model: C.CA.00008-A
Weight: 136g

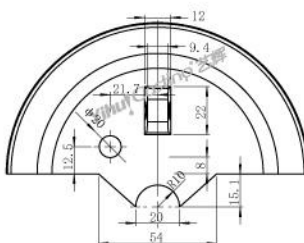

石英前盖

型号: C.CA.00008-B
重量: 148g

Ceramic front cover

Model: C.CA.00008-B
Weight: 148g

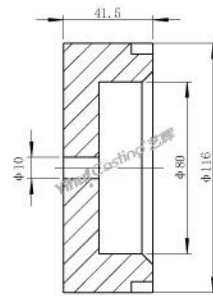
**石英炉盖**

型号: C.CA.FM002
重量: 511g

Ceramic cover

Model: C.CA.FM002
Weight: 511g

包装 Package: 420x315x348mm (69pcs/Carton)

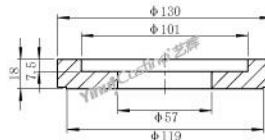
**2公斤、3公斤石英法兰**

型号: C.CA.02055
重量: 314g

2kg/3kg ceramic flange

Model: C.CA.02055
Weight: 314g

包装 Package: 420x315x348mm (90pcs/Carton)

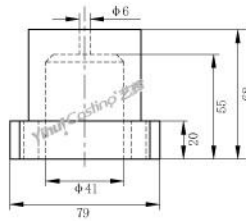
**1公斤石英底座**

型号: C.CD.01000
重量: 300g

1kg ceramic base

Model: C.CD.01000
Weight: 300g

包装 Package: 450x300x240mm (45pcs/Carton)

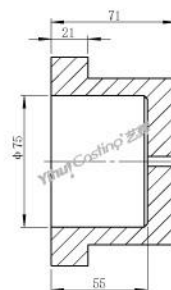
**4公斤石英底座**

型号: C.CD.04000
重量: 787g

4kg ceramic base

Model: C.CD.04000
Weight: 787g

包装 Package: 450x300x240mm (22pcs/Carton)

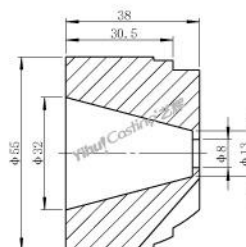
**K2-SM1石英铸造坩埚底座**

型号: C.CD.K0050
重量: 117g

K2-SM1 Ceramic casting crucible base

Model: C.CD.K0050
Weight: 117g

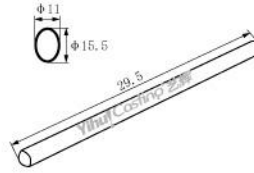
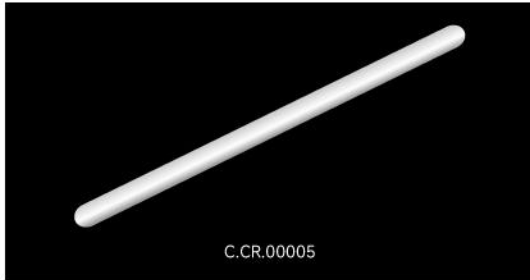

椭圆陶瓷石英棒
型号: C.CR.00005
重量: 69g

Oval ceramic stir rod
Model: C.CR.00005
Weight: 69g

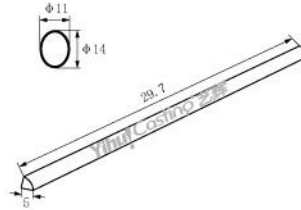
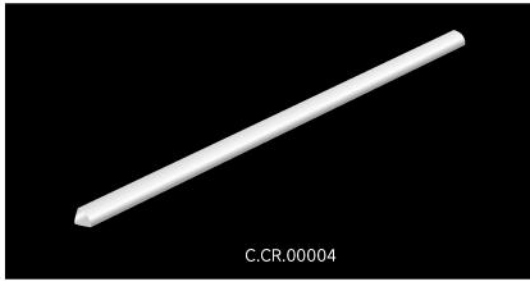

石英棒
型号: C.CR.00004
重量: 62g

Ceramic stir rod
Model: C.CR.00004
Weight: 62g

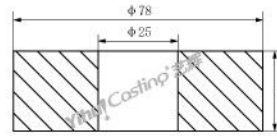

硅酸铝底座
型号: C.CD.078025025
重量: 29g

Aluminum silicate base
Model: C.CD.078025025
Weight: 29g

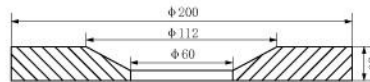

硅酸铝底座
型号: C.CD.200060020
重量: 198g

Aluminum silicate base
Model: C.CD.200060020
Weight: 198g

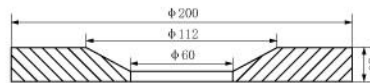

硅酸铝底座
型号: C.CD.200020
重量: 216g

Aluminum silicate base
Model: C.CD.200020
Weight: 216g

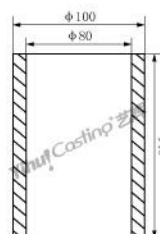

硅酸铝外套
型号: C.CC.VC600-1
重量: 167g

Aluminum silicate shell
Model: C.CC.VC600-1
Weight: 167g

灰皿坩埚 Cupel crucible

灰吹法 (Cupellation) 是一种经典的火试金方法, 主要用于测定金银等贵金属在矿石、合金或精炼产品中的含量。该方法历史悠久, 至今仍在贵金属检测、珠宝鉴定和冶金分析中广泛应用, 尤其适用于高纯度金银样品的定量分析。

Cupellation is a classic pyrometallurgical method. Primarily used to determine the content of precious metals such as gold and silver in ores, alloys, or refined products. This method has a long history. It remains widely used in precious metal testing, jewelry appraisal, and metallurgical analysis, particularly suitable for quantitative analysis of high-purity gold and silver samples.

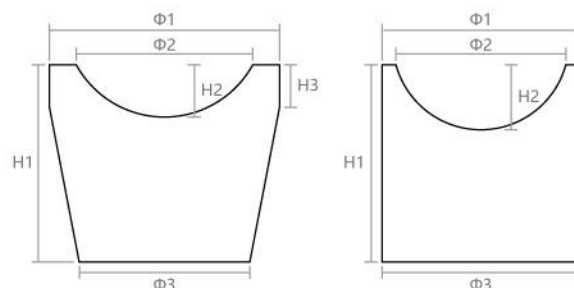

名称 Description	型号 Model	尺寸 Size (mm)						重量 Weight
		Φ1	Φ2	Φ3	H1	H2	H3	
3#灰皿坩埚 3# Cupel crucible	C.CU.00003	26	26	26	26	26	26	17g
4#灰皿坩埚 4# Cupel crucible	C.CU.00004	29	29	29	29	29	29	25g
4A 灰皿坩埚 4A Cupel crucible	C.CU.0004A	27	27	27	27	27	27	22g
4AS 灰皿坩埚 4AS Cupel crucible	C.CU.004AS	27	27	27	27	27	27	22g
Z27 灰皿坩埚 (直筒) Z27 Cupel crucible (Straight)	C.CU.00427	27	27	27	27	27	27	29g
Z40 灰皿坩埚 (直筒) Z40 Cupel crucible (Straight)	C.CU.00440	40	40	40	40	40	40	75g
6A 灰皿坩埚 6A Cupel crucible	C.CU.006A1	40	40	40	40	40	40	52g
6A 灰皿坩埚 6A Cupel crucible	C.CU.006A2	40	40	40	40	40	40	55g
7AS 灰皿坩埚 7AS Cupel crucible	C.CU.007AS	40	40	40	40	40	40	60g
7A 灰皿坩埚 7A Cupel crucible	C.CU.0007A	40	40	40	40	40	40	70g
7X 灰皿坩埚 7X Cupel crucible	C.CU.0007X	40	40	40	40	40	40	73g
8A 灰皿坩埚 8A Cupel crucible	C.CU.0008A	45	45	45	45	45	45	103g
9A 灰皿坩埚 9A Cupel crucible	C.CU.0009A	51	51	51	51	51	51	123g
11# 灰皿坩埚 11# Cupel crucible	C.CU.00011	56.8	56.8	56.8	56.8	56.8	56.8	188g
56mm 灰皿坩埚 56mm Cupel crucible	C.CU.0011-A	56	56	56	56	56	56	166g
12# 灰皿坩埚 12# Cupel crucible	C.CU.00012	80.2	80.2	80.2	80.2	80.2	80.2	450g
14# 灰皿坩埚 14# Cupel crucible	C.CU.00014	110	110	110	110	110	110	1180g

氢氧水焊机及其配件 Oxyhydrogen welding machine



产品特点:

- 1、燃料为水、电，使用方便，储存安全，完全没有高压气体钢瓶爆炸危险的困扰。
- 2、燃烧后产物为水蒸气，被加热物表面纯净，无残留物。
- 3、氢氧水焊机缺水报警功能。
- 4、双重安全泄压阀。
- 5、防回火器、过滤罐、压力控制开关等安全装置，保证整机安全可靠。
- 6、火焰形态改变简易，火咀内径分为不同规格大小，尺寸齐备。
- 7、机型轻巧，操作简便。

PRODUCT FEATURES:

1. Using water and electricity as Welding fuel, Safe storage, free of high pressure gas cylinder explosion risk .
2. Through combustion to make water vapor, and the surface of the heated tiems is pure without residue.
3. Water shortage alarm function.
4. Double safety pressure relief valve.
5. Safety supporting devices inclue: backfire arrestor, filter tank and pressure control switch to ensure the safety and reliability of the whole machine.
6. The flame shape is changeable, various nozzle sizes are available to meet different needs.
7. Compact design, easy operation.

技术参数 PRODUCT FEATURES

名称 Description	105YH水焊机 Water welding machine-1 head	205YH水焊机 Water welding machine-2 head	305YH水焊机 Water welding machine-3 head	405YH水焊机 Water welding machine-4 head	605YH水焊机 Water welding machine-6 head
电源 (AC) Voltage (AC)	220±20V / 110±10V 50~60Hz	220±20V / 110±10V 50~60Hz	220±20V / 110±10V 50~60Hz	220±20V / 110±10V 50~60Hz	220±20V / 110±10V 50~60Hz
工作压力 Working Pressure	0.10-0.20Mpa	0.10-0.20Mpa	0.10-0.20Mpa	0.10-0.20Mpa	0.10-0.20Mpa
耗水量 Water consumption	0.03L/hr	0.06L/hr	0.09L/hr	0.12L/hr	0.18L/hr
产气量 Gas production capacity	100L/hr	200L/hr	300L/hr	400L/hr	>600L/hr
电解液槽容量 Electrolyte tank capacity	2400ML	4200ML	6300ML	8400ML	12400ML
机器尺寸 Machine size	11kg	15kg	22kg	26kg	34kg
重量 Weight	44×30×54cm	53×30×54cm	67×30×54cm	77×30×54cm	102×30×54cm



水电解助剂 (电解粉) Water electrolysis powder

技术参数:

型号: H.PD.00021
纯度: 分析纯
使用比例: 500g兑2500ml水

TECHNICAL PARAMETERS:

Model: H.PD.00021
Purity: 99%
Ratio: 500g mix 2500ml water



水氢火焰枪 (A, B, C, D) Oxyhydrogen gas torch (A, B, C, D)

技术参数:

型号: M.WM.P0002/M.WM.P0003
M.WM.P0004/M.WM.P0005
直径: 0.3、0.4、0.5、0.6 (mm)

TECHNICAL PARAMETERS:

Model: M.WM.P0002/M.WM.P0003
M.WM.P0004/M.WM.P0005
Diameter: 0.3, 0.4, 0.5, 0.6 (mm)

20W台式激光打标机 20W desktop laser marker

产品特点:

- 1、采用风冷式一体化激光器，耗电率低，使用寿命长。
- 2、高速扫描振镜，精度高且可随意调节速度快慢。
- 3、手动调焦三维工作台，方便操作者的使用。
- 4、激光转换效率高，输出功率稳定，激光光束质量好，有效提高工作效率以及标刻字印的美观效果。

技术参数:

型 号: M.SW.DKL20A
 激 光 器: 光纤激光器
 激 光 功 率: 20W
 激 光 波 长: 1064nm
 光 束 质 量 M2: <1.3
 激 光 频 率: 20-200 KHz
 激 光 寿 命: 100,000 hours (average)
 最 小 线 宽: 0.02mm
 最 小 字 符: 0.2mm
 重 复 精 度: 0.001mm
 冷 却 系 统: 内置风冷
 工 作 台: Z轴手动工作台
 切 割 厚 度: 大于 0.3 mm
 标 刻 深 度: 大于 1.0 mm
 标 刻 速 度: ≤7000mm/s
 最 大 功 率: 800W
 供 电 电 源: AC 220V/1P (标配)
 机 器 尺 寸: 780x310x540mm
 包 装 尺 寸: 870x390x740mm
 机 器 重 量: 41Kg (净重) / 60Kg (毛重)
 一 次 标 刻 范 围: 100mm×100mm (标配)
 50mm×50mm / 150mm×150mm (选配)



PRODUCT FEATURES:

1. The use of air-cooled integrated laser, low power consumption, long service life.
2. High-speed scanning galvanometer, high precision and speed adjustable speed.
3. Electric focusing 3D workstation, It is convenient to use for the operator.
4. High conversion efficiency of laser, output power stability, high quality beam of laser, improve efficiency and standard lettering printed aesthetic effect.

TECHNICAL PARAMETERS:

Model: M.SW.DKL20A
 Laser Source: Ytterbium Fiber Laser
 Laser Power: 20W
 Laser Wave Length: 1064nm
 Beam Quality M2: <1.3
 Laser Frequency: 20-200 KHz
 Laser Lifespan: 100,000 hours (average)
 Min Line Width: 0.02mm
 Min Character Height: 0.2mm
 Repeatability: 0.001mm
 Cooling System: Build-in air cool
 Marking Table: Z
 Cutting Thickness: Up to 0.3 mm
 Marking Depth: Up to 1.0 mm
 Marking Speed: ≤7000mm/s
 Max Power Consumption: 800W
 Power Supply: AC 220V/1P
 Machine Dimensions: 780x310x540mm
 Packing size: 870x390x740mm
 Machine Weight: 41Kg (Net Wt.) / 60Kg (Gr. Wt.)
 Marking Area: 100mm x 100mm (Standard)
 50mm x 50mm or 150mm x 150mm (Optional)



机器细节

The machine details



打标示图

Marking sample graph





50W桌台式激光打标机 50W desktop laser marker

产品特点:

- 1、采用风冷式一体化激光器，耗电率低，使用寿命长。
- 2、高速扫描振镜，精度高且可随意调节速度快慢。
- 3、电动调焦三维工作台，方便操作者的使用。
- 4、激光转换效率高，输出功率稳定，激光光束质量好，有效提高工作效率以及标刻字印的美观效果。
- 5、外设安全防护罩以及内设金银等贵金属烟尘回收系统，减少了金银等贵金属的损耗。

技术参数:

型 号: M.SW.DKL50C-Z
 激 光 器: 光纤激光器
 激 光 功 率: 50W
 激 光 波 长: 1064nm
 光 束 品 质 M2: <1.3
 激 光 频 率: 20-200 KHz
 激 光 寿 命: 100,000 hours (average)
 最 小 线 宽: 0.01mm
 最 小 字 符: 0.2mm
 重 复 精 度: 0.001mm
 冷 却 系 统: 内置风冷
 工 作 台: X,Y和Z轴电动工作台
 切 割 厚 度: 大于 0.3 mm
 标 刻 深 度: 大于 1.0 mm
 标 刻 速 度: ≤7000mm/s
 最 大 功 率: 800W
 供 电 电 源: AC 220V/50Hz (标配)
 机 器 尺 寸: 900x460x820mm
 包 装 尺 寸: 1100x510x900mm
 机 器 重 量: 78Kg (净重) / 110Kg (毛重)
 一 次 标 刻 范 围: 100mm×100mm (标配)
 50mm×50mm / 150mm×150mm (选配)

PRODUCT FEATURES:

1. The use of air-cooled integrated laser, low power consumption, long service life.
2. High-speed scanning galvanometer, high precision and speed adjustable speed.
3. Electric focusing 3D workstation, It is convenient to use for the operator.
4. High conversion efficiency of laser, output power stability, high quality beam of laser, improve efficiency and standard lettering printed aesthetic effect.
5. Peripherals and on-site security guards and other precious metals gold and silver dust recovery system, reducing the loss of gold and silver and other precious metals.

TECHNICAL PARAMETERS:

Model: M.SW.DKL50C-Z
 Laser Source: Ytterbium Fiber Laser
 Laser Power: 50W
 Laser Wave Length: 1064nm
 Beam Quality M2: <1.3
 Laser Frequency: 20-200 KHz
 Laser Lifespan: 100,000 hours (average)
 Min Line Width: 0.01mm
 Min Character Height: 0.2mm
 Repeatability: 0.001mm
 Cooling System: Build-in air cool
 Marking Table: X, Y, Z
 Cutting Thickness: Up to 0.3 mm
 Marking Depth: Up to 1.0 mm
 Marking Speed: ≤7000mm/s
 Max Power Consumption: 800W
 Power Supply: AC 220V/50Hz
 Machine Dimensions: 900x460x820mm
 Packing size: 1100x510x900mm
 Machine Weight: 78Kg (Net Wt.) / 110Kg (Gr. Wt.)
 Marking Area: 100mm x 100mm (Standard)
 50mm x 50mm or 150mm x 150mm (Optional)



机器细节
The machine details



打标示意图
Marking sample graph



30W落地式激光打标机 30W standing laser marker

产品特点:

- 1、采用风冷式一体化激光器，耗电率低，使用寿命长。
- 2、高速扫描振镜，精度高且可随意调节速度快慢。
- 3、电动调焦三维工作台，方便操作者的使用。
- 4、激光转换效率高，输出功率稳定，激光光束质量好，有效提高工作效率以及标刻字印的美观效果。

技术参数:

型 号: M.SW.DB30C
 激 光 器: 光纤激光器
 激 光 功 率: 30W
 激 光 波 长: 1064nm
 光束品质M2: <1.3
 激 光 频 率: 20-200 KHz
 激 光 寿 命: 100,000 hours (average)
 最 小 线 宽: 0.02mm
 最 小 字 符: 0.2mm
 重 复 精 度: 0.001mm
 冷 却 系 统: 内置风冷
 工 作 台: X,Y和Z轴电动工作台
 切 割 厚 度: 大于 0.3 mm
 标 刻 深 度: 大于 1.0 mm
 标 刻 速 度: ≤7000mm/s
 最 大 功 率: 500W
 供 电 电 源: AC 220V/50Hz/10A/1P (标配)
 机 器 尺 寸: 800x650x1350mm
 机 器 重 量: 80Kg
 一 次 标 刻 范 围: 100mm×100mm (标配)
 50mm×50mm / 150mm×150mm (选配)

PRODUCT FEATURES:

1. The use of air-cooled integrated laser, low power consumption, long service life.
2. High-speed scanning galvanometer, high precision and speed adjustable speed.
3. Electric focusing 3D workstation, It is convenient to use for the operator.
4. High conversion efficiency of laser, output power stability, high quality beam of laser, improve efficiency and standard lettering printed aesthetic effect.

TECHNICAL PARAMETERS:

Model: M.SW.DB30C
 Laser Source: Ytterbium Fiber Laser
 Laser Power: 30W
 Laser Wave Length: 1064nm
 Beam Quality M2: <1.3
 Laser Frequency: 20-200 KHz
 Laser Lifespan: 100,000 hours (average)
 Min Line Width: 0.02mm
 Min Character Height: 0.2mm
 Repeatability: 0.001mm
 Cooling System: Build-in air cool
 Marking Table: X, Y, Z
 Cutting Thickness: Up to 0.3 mm
 Marking Depth: Up to 1.0 mm
 Marking Speed: ≤7000mm/s
 Max Power Consumption: 500W
 Power Supply: AC 220V/50Hz/10A/1P
 Machine Dimensions: 800x650x1350mm
 Machine Weight: 80Kg
 Marking Area: 100mm×100mm (Standard)
 50mm×50mm or 150mm×150mm (Optional)



机器细节

The machine details



打标示图

Marking sample graph





M.SW.YBT200-5A



M.SW.YBT150-4A / M.SW.YBT200-4A
M.SW.YBT150-4B / M.SW.YBT200-4B

桌面式激光点焊机 Desktop laser welder machine

产品特点:

- 1、一体无震动水冷。
- 2、显微目镜电子CCD 相机双显示。
- 3、七寸彩色实时监控与触控屏操作双合一。
- 4、自适应调压微型电源60W。
- 5、自带摇杆气阀及材料收集盘。
- 6、电动加水缺水水满自动保护。
- 7、自动温控。
- 8、参数调节触控输入、按键、摇杆可选。
- 9、各功能部件独立单元模块设计，便于安装生产与维护。

PRODUCT FEATURES:

1. Integrated vibration-free water cooling.
2. Microscope and CCD camera system dual display.
3. 7"color touch screen with real-time monitoring.
4. Mini adaptive voltage power supply 60w.
5. Rocker, valve & material plate.
6. Electric water filling, water shortage&full automatic protection.
7. Automatic temperature control.
8. Three options that touch screen, press key or rocker to adjust parameter.
9. Each function unit is modular designed, which greatly facilitates installation, production and maintenance.



技术参数 PRODUCT FEATURES

型号 Model	M.SW.YBT200-5A	M.SW.YBT150-4A M.SW.YBT150-4B	M.SW.YBT200-4A M.SW.YBT200-4B
电力需求 Power demand	AC220V+10%/50Hz/20A		
整机耗电功率 Power consumption	≤5KW		
最大激光功率 Maximum laser power	200W	150W	200W
激光波长 Laser wavelength	1064nm		
焊接频率 Welding frequency	≤30Hz		
脉冲宽度 Pulse width	0.1-20ms		
光斑直径 Spot diameter range	0.1-3.0mm		
控制系统 Control system	单片机程序控制 MCU program control		
冷却系统 Cooling system	内置水冷 Built-in water cooling		
尺寸 Size	L660×W350×H345mm	L660×W450×H345mm	L660×W450×H345mm
重量 Weight	40kg	50kg	50kg

激光点焊机
Laser welder machine

产品特点:

- 1、适配调流电源采用抽屉式结构，易于移出，因而机器本身维护方便。
- 2、不需要填充焊料，焊接速度快，接点可靠，工件变形小，成型美观。
- 3、陶瓷激光腔体采用国际知名厂家的产品，保证了设备的高可靠和高性能。
- 4、独特的YAG 晶体冷却方式，提高了光束质量和氙灯的寿命，降低了使用费用。

PRODUCT FEATURES:

1. The power supply adopts the drawer type structure, easy to move out, so the machine itself is easy to maintain.
2. No filler solder, high welding speed, reliable contact, small deformation of the workpiece, beautiful shape.
3. The ceramic laser cavity adopts the products of international famous manufacturers to ensure the high reliability and high performance of the equipment.
4. Unique YAG crystal cooling mode, improve the beam quality and xenon lamp life, reduce the cost of use.



M.SW.YBT200-1A / M.SW.YBT200-1B
M.SW.YBT300-1A



M.SW. YBT200-2A
M.SW. YBT300-2A



技术参数 PRODUCT FEATURES

型号 Model	M.SW.YBT200-1A	M.SW.YBT200-1B	M.SW.YBT300-1A	M.SW. YBT200-2A	M.SW. YBT300-2A
最大激光功率 Maximum laser power	200W	200W	300W	200W	300W
激光波长 Laser wavelength	1064nm				
焊接频率 Welding frequency	≤50Hz				
脉冲宽度 Pulse width	0.1-20ms				
光斑直径 Spot diameter range	0.1-3.0mm				
整机耗电功率 Power consumption	≤7KW	≤7KW	≤8.5KW	≤7KW	≤8.5KW
电力需求 Power demand	AC220V ±10% / 50Hz / 40A				
控制系统 Control system	单片机程序控制 MCU program control				
冷却系统 Cooling system	内置水冷(可分体外置水冷) Built-in water cooling (can be separated from external water cooling)				
尺寸 Size	880×480×1180mm			880×420×1180mm	
重量 Weight	126kg			118kg	

▶ 可定制
Tailored



压片压线效果图

Press flap and press wire effect drawing



3匹镜面轱辘压片机
3 HP Specular rolling mill machine



5.5匹镜面轱辘压片机
5.5 HP Specular rolling mill machine

开料车花
Open material and knurling

技术参数 PRODUCT FEATURES

型号 Model	名称 Name	电机 Motor	压轱直径 Rolling diameter	线坑 Wire size	转速 Rotating speed
N.RO.DD15P	1.5匹压片机 1.5 HP rolling mill	1.1KW (220V)	75mm x 140mm	5.5mmx5.5mm - 1mmx1mm	22 RPM
N.RO.DD20P	2匹压片机 2 HP rolling mill	1.5KW (380V, 220V)	80mm x 152.5mm	6mmx6mm - 1mmx1mm	22 RPM
N.RO.DD30P	3匹压片机 3 HP rolling mill	2.2KW (380V)	87mm x 165mm	7mmx7mm - 1mmx1mm	24 RPM
N.RO.DD40P	4匹压片机 4 HP rolling mill	3KW (380V)	100.5mm x 203mm	8mmx8mm - 1mmx1mm	24 RPM
N.RO.DD55P	5.5匹压片机 5.5 HP rolling mill	4KW (380V)	108mm x 200mm	8mmx8mm - 1mmx1mm	21 RPM

型号 Model	名称 Name	电机 Motor	压轱直径(可定制) Rolling diameter(Tailored)	冷却系统 Cooling system	转速 Rotating speed
N.RO.DD75P	7.5匹压片机 7.5 HP rolling mill	5.5KW	125mmX230mm	带冷却系统 With cooling system	18 RPM
N.RO.DD100P	10匹压片机 10 HP rolling mill	7.5KW	152mmX200mm	带冷却系统 With cooling system	17 RPM
N.RO.DD150P	15匹压片机 15 HP rolling mill	11KW	170mmX200mm	带冷却系统 With cooling system	15 RPM



精密压片机
Precision wire drawing machine



双头双速压片机
Double head double speed wire drawing machine



10P精密钨钢压片机(带收卷)
Precision wire drawing machine

技术参数 Product features

名称 Description	5.5P压片压线机 5.5P Rolling mill for sheet and wire	5.5P精密钨钢镜面压片机 5.5P Precision tungsten steel mirror rolling mill for sheet	8P压片压线机 8P Rolling mill for sheet and wire	8匹单头单速压线机 8P Single head single speed rolling mill for wire	8P金箔压片机 8P Gold foil rolling mill for sheet
型号 Model	M.RO.E0055P	M.RO.E0055P	M.RO.E0080P-A	M.RO.E0080P-B	M.RO.E0080P-C
电压 Voltage	380V / 3PH / 50Hz	380V / 3PH / 50Hz	380V / 3PH / 50Hz	380V / 3PH / 50Hz	380V / 3PH / 50Hz
总功率 Total power	4KW	3.7KW	5.5KW	5.5KW	5.5KW
轧辊直径 Roll diameter	Φ110×188mm	Φ100×60mm	Φ120×208mm	Φ130/Φ120×248mm	Φ150/Φ58×168mm
尺寸 Size	880×580×1400mm	880×580×1400mm	880×580×1400mm	980×1180×1480mm	1080×680×1580mm
重量 Weight	450kg	450kg	550kg	600kg	900kg

名称 Description	8P精密钨钢镜面压片机 8P Precision tungsten steel mirror rolling mill for sheet	8匹双头双速压线机 8P Dual head dual speed rolling mill for wire	10P压片机 10P Rolling mill for sheet	10HP收放卷精密4辊金箔轧延机 10HP Precision 4-roll gold foil rolling mill for sheet	10P精密钨钢压片机 10P Precision tungsten rolling mill for sheet
型号 Model	M.RO.E0080P-W	M.RO.E0080P-B-S	M.RO.E0100P	M.RO.E0100P-A	M.RO.E0100P-W
电压 Voltage	380V / 3PH / 50Hz	380V / 3PH / 50Hz	380V / 3PH / 50Hz	380V / 3PH / 50Hz	380V / 3PH / 50Hz
总功率 Total power	5.5KW	5.5KW	8KW	8.5KW	8.5KW
轧辊直径 Roll diameter	Φ100×60mm	Φ130/Φ120×188mm	Φ150×208mm	Φ150/Φ58×208mm	Φ150/Φ58×208mm
尺寸 Size	880×580×1400mm	1080×1180×1480mm	1080×680×1500mm	1280×1180×1580mm	1280×1180×1580mm
重量 Weight	450kg	900kg	900kg	1100kg	1100kg

名称 Description	15P压片机 15P Rolling mill for sheet	20P加长调速压片机 20P Extended speed regulating rolling mill for sheet	30P加长调速压片机 30P Extended speed regulating rolling mill for sheet
型号 Model	M.RO.E0080P-W	M.RO.E0200P-L	M.RO.E0300P-L
电压 Voltage	380V / 3PH / 50Hz	380V / 3PH / 50Hz	380V / 3PH / 50Hz
总功率 Total power	11KW	12KW	12KW
轧辊直径 Roll diameter	Φ180×248mm	Φ180×298mm	Φ200×368mm
尺寸 Size	1380×780×1580mm	1380×780×1580mm	2000×800×1580mm
重量 Weight	1500kg	1800kg	2000kg



12眼拉线机
12 hole wire drawing machine

型号 Model: M.MF.Q0012
电压 Voltage: 3 Phase 380V; 50Hz
总功率 Total power: 3.5kw
拉线最大直径 Maximum pull wire diameter: Φ 1.2mm
拉线最小直径 Minimum pull wire diameter: Φ 0.1mm
尺寸 Size: 1680×680×1280mm
重量 Weight: 450kg



戒指整形机
Ring shaper

型号 Model: M.MF.Q0031
电压 Voltage: 220V, 50Hz
功率 Power: 0.37KW
尺寸 Size: 780×480×1030mm
重量 Weight: 128kg



单头焊机
Tube welding machine

型号 Model: M.MF.Q0032-1
电压 Voltage: 380V
功率 Power: 1.1KW
尺寸 Size: 950×550×1300mm
重量 Weight: 200KG

开料车花
Open material and knurling



50吨伺服油压机 50T Servo hydraulic press

应用范围:

- 1、金属或非金属零件的压印、挤压成形、浅拉深、整形、覆模及切边等。
- 2、可压制的典型产品有表壳、表带、眼镜框架及零件、像框、餐具、标牌、锁具、汽车零件和五金零件等。

APPLICATION SCOPE:

1. Stamping, extrusion molding, shallow drawing, shaping, covering and cutting of metal or non-metal parts.
2. Typical products that can be pressed include watch cases, watch straps, glasses frames and parts, picture frames, tableware, signs, locks, car parts and hardware parts, etc.

产品特点:

- 1、压力、行程、保压等可按压制工艺要求调整。
- 2、适用于多种压制成形工艺的需要。
- 3、合模后起压快，达到额定压力仅需几秒钟。

PRODUCT FEATURES:

1. Pressure, stroke and holding pressure can be adjusted according to the pressing process requirements.
2. It meets the requirement of various pressing forming processes.
3. After closing the mold, the pressure rises quickly, and only takes a few seconds to reach the rated pressure.

技术参数 PRODUCT FEATURES

型号 Model	M.R.O.YSS50T
公称力 Rated force	500Kn
有效行程 Effective stroke	150mm
最大开口高度 Maximum opening height	250mm
工作台有效面积 Effective area of workbench	300x300mm
下降速度 Descent speed	35mm/S
回程速度 Return speed	50mm/s
重复定位精度 Repeat positioning accuracy	$\leq \pm 0.01$ mm
行程精度 Stroke accuracy	$\leq \pm 0.01$ mm
工作电源 Working power supply	380V
电机功率 Motor power	7.5KW



200T油压机 200T Hydraulic press

功能: 主要适用于金属材料的冲裁、落料、深浅拉伸、翻边、弯曲、成型、双向挤压、复模等。

FUNCTION: It is mainly applicable to the blanking, punching out, deep and shallow drawing, flanging, bending, forming, bidirectional extrusion, die compounding, etc. of metal materials.

用途: 可压制金银首饰、精密五金件、家用电器零部件、五金、灯饰、电机电器、餐具、厨具、以及其它金属容器。

PURPOSE: It can press gold and silver jewelry, as well as precision hardware parts, components of household appliances, hardware products, lighting fixtures, electrical machinery and appliances, tableware, kitchenware, and other metal containers.

产品特点:

- 1、主油缸采用整体锻打并经精密研磨，高压状态下可靠性高。
- 2、机身采用整体焊接床身，整机刚性好，抗压强度高。
- 3、空行速度快，工进速度及压力可调，生产效率高。

PRODUCT FEATURES:

1. The main oil cylinder is integrally forged and precisely ground, ensuring high reliability under high-pressure conditions.
2. The fuselage adopts an integrally welded bed, ensuring the whole machine has good rigidity and high compressive strength.
3. It has a fast idle running speed. The working feeding speed and pressure are adjustable, resulting in high production efficiency.



M.RO.HDT0200-B-2



M.RO.HDT0200-B-3

开料车花
Open material and knurling

技术参数 PRODUCT FEATURES

主缸公称力 Nominal Force of the Main Cylinder	Ton	200	
最大系统压力 Maximum System Pressure	MPa	22	
最大行程 Maximum Stroke	mm	150	
工作台距地面高度 Height of the Workbench from the Ground	mm	1020	
最大开口距离 Maximum Opening Distance	mm	380	
活动工作台行程速度 Travel Speed of the Movable Workbench	下行 Descend	mm/s	150
	回程 Return stroke	mm/s	130
工作台有效面积 Effective Area of the Workbench	左右 Left and right	mm	520
	前后(边缘) Front and rear	mm	500
电机功率 Power of Motor	kW	5.5	
外形尺寸 Overall dimensions	左右 Left and right	mm	1150
	前后 Front and rear	mm	910
	高度 Height	mm	1840

退火炉 Annealing oven

工作原理:

传输机构通过控制装置拖动工件经主炉管和冷却水套，在主炉经加热到高温，然后在冷却套部被急剧冷却。整个过程中，炉管与冷却水套内充满氨分解炉分解的气体(氨气通过分解炉时在催化剂作用下，温度850°C左右分解成氮气和氢气，其中分解的氮气，保护工件不受氧化，分解的氢气则在进出口由电子打火装置打火燃烧，阻止空气进入。

WORKING PRINCIPLE:

The transmission mechanism drags the workpiece through the main furnace tube and cooling water jacket by the control device. The workpiece is to a high temperature in the main furnace and then rapidly cooled in the cooling jacket. Throughout the process, the furnace tube and cooling water jacket are filled with gases decomposed by the ammonia decomposition furnace (ammonia gas is decomposed into nitrogen and hydrogen gas at about 850°C under the action of catalyst when passing through the decomposition furnace. The decomposed ammonia gas protects the workpiece from oxidation, and the decomposed hydrogen gas is ignited and burned by the electronic ignition device at the feed and discharge ports to prevent air from entering.

用途:

主要用于各种马氏体不锈钢的光亮淬火、奥氏体不锈钢的光亮退火(固溶)处理等连续生产，以及各种银、铜、铝等的光亮连续生产，产品经过退火炉处理后，表面会变得光亮，不会被氧化。

APPLICATION:

It is mainly used for the bright quenching of various martensitic stainless steels, bright annealing (solution treatment) of austenitic stainless steels and other continuous production, as well as bright continuous production of various silver, copper, aluminum, etc. After the product is treated by the annealing furnace, surface becomes bright and will not be oxidized.



开料车花
Open material and knurling

技术参数 PRODUCT FEATURES

型号 Model	M.BO.T0008
功率 Power	15KW
电源 Power supply	三相 3 phases, 380V, 50HZ
使用温度 Operating temperature	50-1150°C
设备外形尺寸 Equipment dimensions	L6500xW1150xH1500mm
炉管内尺寸 Inner dimensions of furnace tube	L900xW120xH70-80mm
进料台 Feeding platform	1800mm
主炉 Main furnace	L1800mm, 有效加热区长 Effective heating length 1300mm
冷却区 Cooling zone	2000mm
分解炉 Decomposition furnace	L900xW900xH1300(mm), 3KW, 容量 Capacity : 8m ³

贵金属分析仪 Precious Metal Analyzer

使用贵金属分析仪，您可以放心地买卖黄金、珠宝、硬币以及其他贵重物品。该分析仪准确、易于操作且无损性，提供了一种经济实惠的方法来了解黄金和其他贵金属的纯度和成分。

- 台式仪器可在几秒钟内提供精确的贵金属验证、克拉和纯度。
- 在现场测量贵重物品中的黄金、白银和其他贵金属，以快速准确地定价。
- 快速识别假货，具有镀金警报和检测有害元素(如铅和镉)的功能。

Buy and sell gold, jewelry, coins, and other valuables with confidence using the precious metal analyzer. Accurate, easy to use, and nondestructive the analyzer provides an affordable way to know the purity and composition of gold and other precious metals.

- The countertop instrument delivers accurate precious metal verification, karatage, and fineness in seconds.
- Measure the gold, silver, and other precious metals in your valuables on-site to quickly and accurately price items
- Identify fake items fast with the alert for gold plating and detection of hazardous elements (e.g., lead and cadmium)

功能:

- 测试1%至99.99%的金和银、铂和钯的所有颜色
- 试验结果显示了Kara值和所有金属元素百分比
- 使用纯银进行简单的一步校准
- 所有数据均可存储在计算机中
- 报告可以用A4/A5和标签形式打印出来
- 按照简单的步骤识别非金和镀金
- 12.1英寸的大屏幕，配备全彩触屏

FUNCTION:

- Tests all colors of gold from 1% to 99.99% and silver, platinum, and palladium
- Test results shows both karat value and all percentages of metal elements
- Easy one-step calibration using pure silver
- All data could be stored in the computer
- Reports can be printed out with A4/A5 and label form
- Follow easy steps to identify non-gold and plated gold
- 12.1 inches bigger display with full color touch-screen



珠宝店
Jewelry shops



典当行
Pawning center



可测试的元素 TESTABLE ELEMENTS

200E 金, 银, 铜, 铂, 钯, 铱, 镉等

Au, Ag, Cu, Pt, Pd, Ir, Cd, ect.

400E 金, 银, 铜, 铂, 钯, 铱, 镉, 镍, 铈, 铊

Au, Ag, Cu, Pt, Pd, Ir, Cd, Ni, Rh, Zn

600E 金, 银, 铜, 锌, 镍, 钯, 铂, 铱, 铈, 镉, 铅, 锡, 钴, 铁, 铬, 钨, 铋, 锗, 铟, 铪

Au, Ag, Cu, Zn, Ni, Pd, Pt, Rh, Ir, Cd, Pb, Sn, Co, Fe, Cr, W, Sb, Ge, Os, Re

800E 金, 银, 铜, 锌, 镍, 钯, 铂, 铱, 铈, 镉, 铅, 锡, 铋, 锗, 铟, 铪, 铷, 铯, 钽, 钼, 镁

Au, Ag, Cu, Zn, Ni, Pd, Pt, Rh, Ir, Cd, Pb, Sn, Sb, Co, Fe, Cr, W, Re, Ge, Os, In, Ru, Ti, Al, Mg

技术参数 PRODUCT FEATURES

型号 Model	M.AU200E	M.AU400E	M.AU600E	M.AU800E
电压 Voltage	AC 220V + 10V, or AC 110V± 10V, 50/ 60 Hz			
额定功率 Rated power	200W			
精度 Precision	+10ppm-0.1%	+10ppm-0.1%	0.03%	0.03%
分析范围 Analysis Range	1%-99.99%	1%-99.99%	1 ppm to 99.99%	1 ppm to 99.99%
工作原理 Working Principle	能量色散X射线荧光 Energy Dispersive X-ray Fluorescence			
探测器 Detector	气体比例探测器 Gas Proportional Detector	混合探测器 Hybrid Detector	Si-Pin探测器 Si-Pin Detector	高性能硅针探测器 High-performance Si-Pin Detector
检测限值 Detection limit	100ppm 最佳物质效果 100ppm Best substance effect			
测量时间 Measurement Time	30秒自动模式 30 seconds Auto mode	30秒~60秒 30sec~60sec		
尺寸 Size	460x390x400mm			
重量 Weight	33kg	30kg		

铸造工艺流程 CASTING PROCESS



注：画册所有图片及资料仅供参考，以实物为准，本画册资料版权所有，翻版必究。
如有更改不另行通知，最终解释权归本公司。

Photo in catalog is subject to real product. Yihui reserves the right to amend the content without prior notice.
All rights reserved any copies will be investigated. Yihui reserves the right of final interpretation.



注：画册所有图片及资料仅供参考，以实物为准，本画册资料版权所有，翻版必究。
如有更改不另行通知，最终解释权归本公司。

Photo in catalog is subject to real product. Yihui reserves the right to amend the content without prior notice.
All rights reserved. Any copies will be investigated. Yihui reserves the right of final interpretation.



Yihui Casting®

艺辉铸造科技有限公司
Yihui Casting Technology Co.,Ltd

2026.01

📍 广东省广州市番禺区沙南路50号
No.50, Shan Road, Panyu District, Guangzhou City, Guangdong Province, China
☎ +86-20-347 34999 / 34734 666 / 8487 1666
📠 +86-20-8487 2122
✉ info@yihuicasting.com
🌐 yihuicasting.com yihuicasting.cn



浏览官网



Browse Website