

Yihu! Casting®



工具和耗材 **TOOLS**  
**& CONSUMABLES**

广州 Guangzhou / 深圳 Shenzhen / 东莞 Dongguan / 义乌 Yiwu / 梧州 Wuzhou / 香港 HongKong / 泰国 Thailand

# 发展历程

## DEVELOPMENT HISTORY



### 2003

深圳市艺辉首饰器材有限公司成立  
Shenzhen Yihui Jewelry Equipments Co., Ltd established.

### 2005

广州市艺辉铸造科技有限公司成立  
Guangzhou Yihuicasting Technology Co., Ltd established

### 2008

艺辉香港公司成立，同年广州运营总部设立  
Yihui (HK) Ltd. established, together with establishment of Yihuicasting Guangzhou Headquarter

### 2009

广东瀚辉石墨有限公司成立，专注于石墨石英制品生产  
Guangdong Hanhui Graphite Co., Ltd. established, specialize in production of Graphite and ceramic products.

### 2010

艺辉义乌及东莞长安店开业，同年瑞辉自动化系统（广东）有限公司成立  
Under Yihuicasting brand, added a shop in Yiwu city and Changan, Dongguan City separately, in the same year, Yihui Casting Technology Co., Ltd. established.

### 2011

艺辉深圳求水山店开业，同年艺辉产品远销六十六个国家  
Opened a shop in Qiushuishan, Shenzhen City, by this time, our products has been sold to more than 60 countries.

### 2012

艺辉番禺大罗塘店开业  
Celebrated the opening of our shop in Daluotang, Panyu, Guangzhou City.

### 2013

艺辉深圳李朗旗舰店开业，依托艺辉品牌，已形成石英制品、石墨制品、首饰机械、耗材及工具等完善的精密失蜡铸造产品体系  
Opened a flagship store in Lilang, Shenzhen city. Rely on Yihuicasting brand, formed a complete precious lost wax casting products supply system, including ceramic products, graphite products, jewelry machines, consumables, tools, etc.

### 2014

艺辉广西梧州店和深圳布心店开业；深圳李朗旗舰店成功扩大升级，经营面积达到2000多平方；韬辉科技（佛山）有限公司成立  
Guangxi Wuzhou store and Shenzhen Buxin store opened, Shenzhen Li Lang flagship store successfully expand upgrading, operating area has reached 2000 square meter. Taohui Technology (Foshan) Co., Ltd established

### 2015

Yihui Casting 商标注册成功  
Yihui Casting trademark registered successsfully.

### 2016

艺辉深圳横岗店开业  
Opened a shop in Henggang, Shenzhen City.

### 2017

艺辉番禺沙南旗舰店开业，大罗塘店合并至沙南店  
Yihui Shanan flagship shop is opened in Panyu, Daluotang shop merged to Shanan shop.

### 2019

安徽驰辉新材料有限公司成立  
Anhui Chihui New Materials Co., Ltd established

### 2022

华智科创中心开始营业  
Huazhi Technology Innovation Center set up

### 2024

艺辉铸造（泰国）有限公司成立  
Yihui Casting (Thailand) Co., Ltd established

# 核心理念

## CORE CONCEPT

**愿景:** 成为全球首饰铸造领域卓越品牌

**使命:** 秉承工匠精神, 持续创新驱动, 致力于首饰行业的技术进步

**价值观:** 客户第一, 技术领先, 热忱开放, 学习拼搏, 创新共赢

**客户第一:** 客户是工作的起点和奋斗方向, 以满足客户的需求, 为所有工作的出发点和落脚点。

**技术领先:** 技术是企业立身之本, 做市场竞争的领先者, 保持持续领先。

**热忱开放:** 工作热忱, 个人开放, 积极吸收新鲜事物, 积极拥抱变化, 不故步自封; 团队包容, 吸纳各类人才, 兼容并蓄, 实现自赋能, 自推动, 自优化, 自修复!

**学习拼搏:** 艺辉人在学习中发现更优秀的自己, 勇于拼搏, 不屈不挠, 勇于担当, 积极进取, 乐于奉献!

**创新共赢:** 持续创新才能创造更高价值, 利他心, 与客户、员工、供应链、社会共同创造、共享成果与未来。

艺辉不追求短期利益, 在创新、文化、制度、核心竞争力等方面保持持续投入和竞争优势, 实现企业的协调可持续发展。

**Vision:** To become one of global leading brand in jewelry casting area

**Mission:** Adhering to the spirit of craftsmanship, driven by continuous innovation, devoted to the technical progress in the jewelry industry

**Values:** Customer first, leading technology, enthusiasm and openness, learning and hard working, innovation and double win

**Customer first:** The customer is the starting point and direction of our work in order to meet the needs of various customers, the starting point and foothold for all our works.

**Leading technology:** Technology is the foundation of Yihucasting, to be the leader in competitive market, as well as to keep constant leading.

**Enthusiasm and openness:** enthusiasm for work, personal openness, absorb new things and embrace change actively, uncomplacent. team member is inclusive with each other, absorbing all kinds of elites, inclusive and poised mutually, self-empowerment, self-promotion, self-optimization, self-repair!

**Learning and hard working:** Yihui people shall find better themselves in learning, the courage themselves to hard working, indomitable, positive to take responsibility, proactive, willing to contribute!

**Innovation and double win:** Constant innovation creates higher value, altruism, and co-create with customers, employees, supply chains. co-creates Society co-creates and shares the fruits and the future and shares the fruits & future together.

Yihucasting does not pursue short-term benefits, meanwhile maintains continuous investment and competitive advantages in innovation, culture, system, core competitiveness, etc., to achieve coordinated and sustainable development of Yihucasting.

**Yihu! Casting 艺辉** | 专注于首饰铸造  
Specializing In Jewelry Casting

提供铸造一站式解决方案 PROVIDE FULL CYCLE CASTING SOLUTION

### 设备 Equipment

3D打印机、压模机、注蜡机、搅粉机、电炉、压粉机、石膏清洗机、熔金机、铸造机、铸锭机、撒珠机等。  
3D Printer, Vulcanizer, Wax injector, Vacuum mixer, Burnout oven, Cleaning machine, Melting furnace, Casting machine, Gold bar machine, Granulating machine, etc.

### 工具和材料 Tools and Materials

树脂、铸造蜡、硅胶、石膏粉、石墨、石英、工匠台、锤子、剪钳、油槽等。  
Resin, Casting wax, Silicone rubber, Investment powder, Graphite, Ceramic, Bench, Hammer, Pliers, Steel trough, etc.

### 培训 Training

从首饰铸造设计起版开始到制模、注蜡、开粉、焙蜡、熔炼铸造等工艺流程全方面技能培训。  
Comprehensive training of entire jewelry making process, from 3D design, wax injection, mixing, burning, die casting, continuous casting, granulating, grinding and polishing.

### 工艺技术 Technics and Technology

我们是专业的失蜡铸造整体解决方案提供商, 拥有整套失蜡铸造工艺流程技术。  
Provide full cycle jewelry casting & jewelry polishing solutions.

## 铸造 CASTING



始于 SINCE **2003** | 珠宝首饰合作工厂 Cooperated Jewelry Factory **5000\*** | 合作院校 Cooperated University **1000\***

# ABOUT US

关于艺辉

始创于  
Since

2003

生产基地  
Production Facility

35000m<sup>2</sup>

资深工程师  
Engineers

20+

国家专利  
National Patents

100+



艺辉旗下公司 YIHUI GROUP



SAIHUI 赛辉

万协 VANSHAPE

COLDSOAR 冷硕



# 匠心传承 创新引领

## MASTERFUL CRAFTSMANSHIP, PIONEERING INNOVATION

艺辉铸造自2003年成立以来，始终专注于推动中国精密铸造技术行业的创新与发展，作为国内领先的高端首饰铸造设备与整体解决方案供应商，公司凭借持续的自主研发与技术突破，成功打破首饰设备长期被国外垄断的局面，树立了国内精密铸造领域的技术标杆与设备制造典范。

公司构建了涵盖智能铸造设备、自动化研磨抛光系统及配套专用材料的完整产业链体系，拥有超35,000平方米的现代化生产基地，组建了由20余位资深工程师构成的专业研发团队，已获得100多项国家专利。产品畅销全球近150个国家和地区，为全球首饰制造业提供高性能、高稳定性的专业设备与全面技术支持。

技术方面，艺辉不断推进智能铸造与精密工艺的融合创新，在自动化研磨抛光等关键环节达到国际先进水平。在材料领域，公司自主开发的铸造蜡、高端石墨和石英制品等配套材料，为行业提供了一体化的材料解决方案，进一步提升工艺品质与生产效率。

秉承“**客户第一、技术领先、热忱开放、学习拼搏、创新共赢**”的价值观，艺辉建立了符合ISO9001:2015认证的严格质量管理体系，确保从设备制造到售后服务的每一个环节都符合精密铸造的高标准要求。

未来，艺辉将持续加大研发投入，致力于在精密铸造技术领域取得更多突破性专利，扩大国际市场份额。公司将进一步拓展全球服务网络，计划三年内建立更完善的海外代理商体系和供应链布局，为全球客户提供更快捷、更高效、更专业的本地化服务。

公司将重点推进智能制造系统与数智化服务平台建设，集成物联网与大数据技术，为客户提供实时工艺支持与设备运维服务。同时，艺辉将继续深化与国际顶尖供应商的战略协作，共同推动行业工艺升级与技术变革。

艺辉期待与全球伙伴携手，共建协同、高效、可持续的首饰制造产业生态。我们将以创新的技术、卓越的品质和完善的服务，持续为客户创造价值，助力行业迈向智能化、精密化、国际化新阶段。

**我们坚信：创新驱动发展，品质赢得未来。**艺辉将继续以领先的技术实力与开放的合作精神，与业界同仁共同缔造首饰行业更美好的明天。

Established in 2003, Yihui Casting has consistently dedicated itself to propelling innovation and advancement in China's precision investment casting industry. As a premier domestic supplier of high-end jewelry casting equipment and integrated casting solutions, we have achieved breakthrough innovations through persistent independent R&D, successfully dismantling longstanding international monopolies in jewelry manufacturing equipment and establishing new benchmarks for technological excellence and manufacturing standards in China's precision casting domain.

With a complete industrial chain encompassing intelligent casting machines, auto grinding and polishing systems, and specialized supporting materials and a modern 35,000m<sup>2</sup> production facility, Yihui Casting leverages its professional R&D team more than 20 engineers and 100 national patents to supply high-performance, reliable equipment and technical support to the global jewelry manufacturing sector across nearly 150 countries.

Technologically, Yihui Casting drives innovation by integrating intelligent casting with precision processes, achieving internationally advanced standards in key areas like automated polishing. In materials science, its proprietary casting waxes, high-grade graphite, and quartz products provide integrated solutions that enhance both quality and manufacturing efficiency for the industry.

Upholding its values of "**Customer First, Technology Leadership, Passion & Openness, Learning & Perseverance, and Innovative Win-Win**," Yihui Casting maintains an ISO 9001:2015 certified quality management system. This guarantees strict adherence to high precision casting standards across all operations—from manufacturing to after-sales support.

Moving forward, Yihui Casting will intensify R&D investment to secure more groundbreaking patents in precision casting and expand its global market share. The company will strategically extend its worldwide service network, planning to establish a more robust overseas distributor system and supply chain layout within three years. This initiative aims to provide global clients with faster, more efficient, and professional localized services.

Yihui Casting will make a strategic emphasis on advancing its intelligent manufacturing systems and digital service platform. This integrated infrastructure, powered by IoT and big data, is designed to provide clients with real-time process support and comprehensive equipment maintenance services. In parallel, Yihui Casting is committed to deepening its strategic alliances with top-tier international suppliers, collaborating to pioneer industry-wide process enhancements and technological evolution.

Yihui Casting looks forward to partnering with global peers to build a more collaborative, efficient, and sustainable ecosystem for the jewelry manufacturing industry. We are committed to creating enduring value for our customers through innovative technology, superior quality, and comprehensive services, driving the industry toward a new era of intelligence, precision, and global integration.

**We firmly believe that innovation is the catalyst for progress, and quality is the foundation of the future.** With leading technological capabilities and an open, collaborative spirit, Yihui is committed to working with industry peers to forge a brighter tomorrow for the jewelry sector.

# 艺辉对于首饰制造核心理念形成了我们坚定的使命

YIHUI'S CORE PHILOSOPHY OF JEWELRY CASTING HAS FORMED OUR STEADFAST MISSION

## 卓越的毛坯制备 EXCELLENT RAW PREPARATION

我们坚信，创造卓越的首饰必须始于高品质的毛坯制备。因此，我们深入研究并不断优化整个铸造工艺流程，建立了精密的工艺技术解决方案，以确保毛坯的卓越质量。这一步骤被视为制造卓越产品的不可或缺的基础。

We firmly believe that creating excellent jewelry must start with high-quality raw preparation. Therefore, we have conducted in-depth research and continuously optimized the entire casting process, and established precise process technology solutions to ensure the excellent quality of the blanks. This step is seen as an indispensable foundation for making superior products.

## 自动化抛光 AUTOMATIC POLISHING

我们重视降低在抛光和研磨等环节的人力资源投入，积极采用自动化设备进行生产。我们专注于提高生产效率，以确保产品的一致性和高品质。这一理念旨在降低成本的同时保持质量，以满足市场需求。

We pay attention to reducing the human resource investment in polishing and grinding, and actively use automated equipment for production. We focus on improving production efficiency to ensure product consistency and high quality. This concept aims to reduce costs while maintaining high quality to meet market demand.



综上所述，我们构建了两个独立的产品线，一个专注于铸造，另一个专注于抛光，结合设备，材料，工艺技术以及培训，以全面推动我们的愿景，为客户提供卓越的首饰制造工艺及技术服务。

In summary, we have built two separate product lines, one specialize in casting and the other in polishing, combining equipment, materials, process technology, and training to fully drive our vision to provide our customers with excellence in jewelry manufacturing Process and technical services.



## 我们的客户 Our customers

---

### ASIA

Syria  
Saudi Arabia  
EAU  
Russia  
Kazakistan  
Kirghizistan  
India  
Indonesia  
Thailand  
Cambodia  
Vietnam  
Indonesia  
Thailand  
Cambodia  
Vietnam  
Pakistan

### EUROPE

Portugal  
Spain  
France  
England  
Germany  
Polond  
Denmark  
Greece  
Romania  
Czech Republic

---

### OCEANIA

Australia  
New Zealand

### AFRICA

Algeria  
Tunisia  
Morocco  
Libya  
Egypt

---

### AMECIA

USA  
Mexico  
Brazil  
Argentina  
Peru



### 制模 Molding

- 01 — 硅胶 Silicone rubber
- 02 — 压模框 Aluminum mould frame
- 03 — 压模珠 Mould vulcanizing balls
- 刀柄 Handles
- 03 — 掏底刀/雕蜡刀 Carving knife/Wax carving knife
- 04 — 蜡条 Wax ring tube
- 手镯蜡 Bracelet wax
- 蜡片 Wax slice



### 焙烧 Burn

- 05 — 树芯模 Sprue wax mould
- 胶底座 Round shape rubber base
- 06 — SUS304钢盅 SUS304 flask
- 06 — 钢盅套 Flask cover
- 07 — 钢盅钳/夹 Flask tong
- 坩埚钳 Crucible tong
- 08 — 热电偶/投料铲 Thermo couple/Shovel
- 09 — 吸水纸 Absorbent paper
- 美纹胶纸 Masking tape
- 车花胶 Adhesive tape



### 执模 Hand polishing

- 10 — 工作台 Desk
- 11 — 扩大器 Ring stretcher
- 13 — 镊子 Tweezer
- 15 — 剪钳 Pliers
- 25 — 卓弓 Sam bow
- 26 — 锯条 Saw blades
- 27 — 锉 File
- 40 — 铲刀 Graver
- 43 — 针钻 Burs and drills
- 45 — 铁锤 Hammer
- 51 — 篆刻 Chisel carving
- 56 — 台木/手环 Bench pin/Bracelet clamp
- 57 — 字印 Stamp



### 镶嵌 Stone inlay

- 58 — 微镶机器 Micro stone setting machine
- 微镶工具 Stone setting tool
- 61 — 四方窝砧 Square steel dapping block
- 62 — 坑铁 Dapping block
- 63 — 套装窝珠作 Punch dapping set
- 66 — 镶口模具 Bezel block
- 71 — 台灯 Desk lamp



### 焊接 Soldering

- 73 — 手镯切割机 Rotary tumblers
- 珍珠钻孔机 Pearl Drilling Machine
- 74 — 点焊机 Spot Welder
- 75 — 火枪 Torch
- 76 — 油壶/点火器/焊粉 Oil pot/Lighter/Welding powder
- 77 — 风球 Leather air bellow
- 气体打火机 Gas torch



### 电镀 Electroplating

- 80 — 石英烧杯 Ceramic beaker
- 洗货挂勾 Hanging hook
- 过滤纸 Filter paper
- 81 — 铂金钛网 Platinum titanium mesh
- 电金机 Electro plating machine
- 82 — 电镀笔笔嘴 Electroplated pen tip
- 83 — 塑料量杯 Measuring cup

### 抛光 Polishing

- 84 — EP300电解抛光机 EP300 Electric polishing machine
- 85 — 磁力抛光机 Magnetic tumbler



- 91 —— 涡流机 Polishing tumbler
- 93 —— LS-32立式离心研磨机 LS-32 Vertical centrifugal grinding machine
- 94 —— 双层干式滚筒研磨机 Dry barrel polishing machine with double layer
- 95 —— 震动抛光机 Vibration polishing machine
- 96 —— 滚桶抛光机 Barrel polishing machine
- 98 —— 其它抛光机 Other polishing machine
- 100 —— 打磨机 Polishing machine
- 103 —— 吊磨机 Flex shaft
- 110 —— 蒸汽清洗机 Steam cleaning machine
- 111 —— 抛光台 Buff polishing machine
- 114 —— 超声波清洗机 Ultrasonic cleaning machine
- 116 —— 抛光耗材 Polishing consumables
- 128 —— 硅胶磨头 Polyster polishing bits
- 136 —— 毛刷 Brush
- 144 —— 有柄双层百洁布 Nylon Buffing Polishing Wheel  
铁芯毛刷 Iron core brush
- 146 —— 布轮 Buff
- 148 —— 麻轮 Flax wheel
- 147 —— 尼龙轮 Nylon wheel
- 151 —— 羊毛轮/飞碟轮 Wool wheel/Split wheel
- 152 —— 柏轮 Cloth wheel  
海绵抛光轮 Sponge polishing wheel
- 153 —— 飞翼轮 Non woven polishing wheel  
打磨轮 Radial shape disc
- 154 —— 拉丝轮 Wire drawing wheel
- 155 —— 金刚石切割片 Diamond cutter
- 157 —— 砂纸 Sanding paper
- 158 —— 砂带 Sanding belt
- 159 —— 飞碟夹 Split lap clamp  
夹砂棒 Rod  
玛瑙刀 Agate knife
- 160 —— 钢压 Steel burnisher
- 162 —— 夹砂针 Saning paper clip
- 163 —— 旋转锉 Rotary file
- 165 —— 戒指绒棒 Felt ring buff  
手锤棒/手镯内抛棍 Felt bange buff
- 166 —— 木柄铜丝刷 Brass wire brush with handle  
油漆刷 Paint brush
- 167 —— 防酸手套 Acid proof glove  
防护手套 High temp glove  
防护服 Protective clothing  
手指套 Finger guard
- 168 —— 毛巾 Towel  
抛光粉 Polishing powder  
硼酸粉 Boric acid powder  
干打砂机 Dry sand-making machine
- 168 —— 喷砂机 Sanding blasting machine



- 开料车花 Mechanical engraving**
- 171 —— 雕刻机 Graving machine
  - 174 —— 压片机 Rolling mill
  - 178 —— 戒指内孔刻字机 Inside ring engraver
  - 179 —— 拉线板 Drawingplates



- 宝石鉴定 Gem Identification**
- 180 —— 鉴定设备 Identification equipment
  - 185 —— 数码摄影箱 Photography Box



- 测量检测 Measuring instruments**
- 187 —— 戒指尺 Ring stick
  - 189 —— 戒指圈 Ring sizes
  - 190 —— 卡尺 Calipers
  - 192 —— 放大镜 Jewelry loupe
  - 196 —— 显微镜 Microscope
  - 202 —— 电子称 Electronic scales
  - 206 —— 手掌称 Pocket digital scale
  - 211 —— 密度计 Density meter

硅胶  
Silicone rubber

20kg/箱/Carton



R.SR.00001



R.SR.00008



R.SR.00008-E



R.SR.00008-B



R.SR.00007



R.SR.00060



R.SR.00022



R.SR.00037



意大利(尼成)硅胶  
Italy silicone rubber

R.SR.00005  
25kg/箱/Carton



GOLD STAR 高温黄色硅胶  
High temp resistant  
yellow silicone rubber

R.SR.00016 5kg/箱/Carton



日本矽胶  
Japan silicone rubber

R.SR.00009  
20kg/箱/Carton



新珍宝压模胶  
Silicone rubber

R.NR.00003  
50lb/箱/Carton



进口压模胶  
Thailand silicone rubber

R.NR.00004  
50lb/箱/Carton

castaldo 压模胶



R.NR.00006  
2.25kg/箱/Carton



R.NR.00005  
50lb/箱/Carton



R.NR.00007  
50lb/箱/Carton



R.NR.00008  
50lb/箱/Carton



液体硅橡胶 Liquid silicone rubber



R.SR.XY408A / R.SR.XY408B  
5kg/桶/Barrel

R.SR.XY508A / R.SR.XY508B  
5kg/桶/Barrel

R.SR.XY550A / R.SR.XY550B  
5kg/桶/Barrel



R.SR.XY308A-5KG / R.SR.XY308B-5KG  
5kg/桶/Barrel



R.SR.XY306  
25kg/桶/Barrel



压模框 (可订制)  
Aluminum mould frame (tailored)

代码 Model	外框尺寸 External frame size	内框尺寸 Inner frame size	高度 Height
Z.T.MK.01012	130×110mm	90×70mm	12mm
Z.T.MK.01015	130×110mm	90×70mm	15mm
Z.T.MK.01018	130×110mm	90×70mm	18mm
Z.T.MK.01021	130×110mm	90×70mm	21mm
Z.T.MK.01024	130×110mm	90×70mm	24mm
Z.T.MK.01027	130×110mm	90×70mm	27mm
Z.T.MK.01030	130×110mm	90×70mm	30mm
Z.T.MK.01033	130×110mm	90×70mm	33mm
Z.T.MK.01036	130×110mm	90×70mm	36mm
Z.T.MK.01039	130×110mm	90×70mm	39mm



代码 Model	外框尺寸 External frame size	内框尺寸 Inner frame size	高度 Height
Z.T.MK.02012	150×110mm	73×47mm	12mm
Z.T.MK.02015	150×110mm	73×47mm	15mm
Z.T.MK.02018	150×110mm	73×47mm	18mm
Z.T.MK.02021	150×110mm	73×47mm	21mm
Z.T.MK.02024	150×110mm	73×47mm	24mm
Z.T.MK.02027	150×110mm	73×47mm	27mm
Z.T.MK.02030	150×110mm	73×47mm	30mm
Z.T.MK.02033	150×110mm	73×47mm	33mm
Z.T.MK.02036	150×110mm	73×47mm	36mm

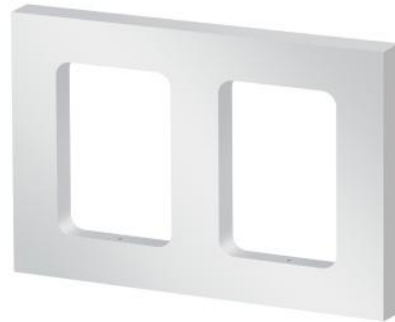

代码 Model	外框尺寸 External frame size	内框尺寸 Inner frame size	高度 Height
Z.T.MK.04012	200×150mm	73×47mm	12mm
Z.T.MK.04015	200×150mm	73×47mm	15mm
Z.T.MK.04018	200×150mm	73×47mm	18mm
Z.T.MK.04021	200×150mm	73×47mm	21mm
Z.T.MK.04024	200×150mm	73×47mm	24mm
Z.T.MK.04027	200×150mm	73×47mm	27mm
Z.T.MK.04030	200×150mm	73×47mm	30mm
Z.T.MK.04033	200×150mm	73×47mm	33mm
Z.T.MK.04036	200×150mm	73×47mm	36mm

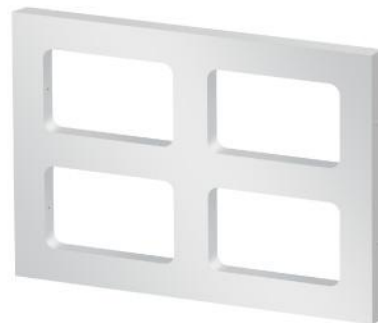

代码 Model	外框尺寸 External frame size	内框尺寸 Inner frame size	高度 Height
Z.T.MK.06012	200×180mm	73×47mm	12mm
Z.T.MK.06015	200×180mm	73×47mm	15mm
Z.T.MK.06018	200×180mm	73×47mm	18mm
Z.T.MK.06021	200×180mm	73×47mm	21mm
Z.T.MK.06024	200×180mm	73×47mm	24mm
Z.T.MK.06027	200×180mm	73×47mm	27mm
Z.T.MK.06030	200×180mm	73×47mm	30mm
Z.T.MK.06033	200×180mm	73×47mm	33mm

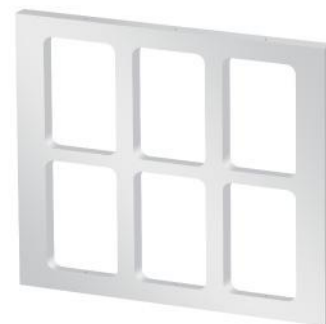

压模珠  
Mould vulcanizing balls



T.MK.00007  
Φ13×H9.8mm



T.MK.00008  
Φ11×H4.8mm



T.MK.00009  
Φ9×H5.8mm



T.MK.00034  
Φ13×H9.8mm



T.MK.00035  
Φ11×H4.8mm



T.MK.00036  
Φ9×H5.8mm

刀柄  
Handles



T.SB.00001 120x12mm



T.SB.00002 125x12mm



T.SB.00004 125x22mm

英国刀片  
Swann morton blades

代码 Model	名称 Description	尺寸 Size	包装 Package
T.SB.00010	10A	40×7.8×0.4mm	100 Pcs/Box
T.SB.00011	11	41×6.5×0.4mm	100 Pcs/Box
T.SB.00012	12	37×11×0.4mm	100 Pcs/Box
T.SB.00192	15C	40×5.8×0.4mm	100 Pcs/Box



掏底刀  
Carving knife

代码 Model	刀头长度 Knife length	刀头厚度 Knife thickness	手柄长度 Handle length	手柄直径 Handle diameter
T.SB.00065	25mm	0.5mm	118mm	Φ8mm



雕蜡刀  
Wax carving knife

代码 Model	刀头长度 Knife length	刀头厚度 Knife thickness	手柄长度 Handle length	手柄直径 Handle diameter
T.SB.00053	25mm	0.5mm	118mm	Φ8mm



蜡条 Wax ring tube

单位 Unit: mm

名称 Description	型号 Model	Φ	X	Y	Z
蜡条8T7.6-138 Wax ring tube 8T7.6-138	T.ET.WR8T76	18.3	7.6	3.0	138
蜡条8A7.6-138 Wax ring tube 8A7.6-138	T.ET.WR8A76	18.3	7.6	3.0	138
蜡条6.5A8.8-138 Wax ring tube 6.5A8.8-138	T.ET.WR65A88	17.0	8.8	3.0	138
蜡条6.5T8.8-138 Wax ring tube 6.5T8.8-138	T.ET.WR65T88	17.0	8.8	3.0	138
蜡条7T8.5-138 Wax ring tube 7T8.5-138	T.ET.WR7T85	17.5	8.5	3.0	138
蜡条7A8.5-138 Wax ring tube 7A8.5-138	T.ET.WR7A85	17.5	8.5	3.0	138
蜡条7.5T8.1-138 Wax ring tube 7.5T8.1-138	T.ET.WR75T81	17.8	8.1	2.8	138
蜡条7.5A8.1-138 Wax ring tube 7.5A8.1-138	T.ET.WR75A81	17.8	8.1	2.8	138
蜡条6T9-138 Wax ring tube 6T9-138	T.ET.WR6T9	16.3	9	3.2	138
蜡条6A9-138 Wax ring tube 6A9-138	T.ET.WR6A9	16.3	9	3.2	138

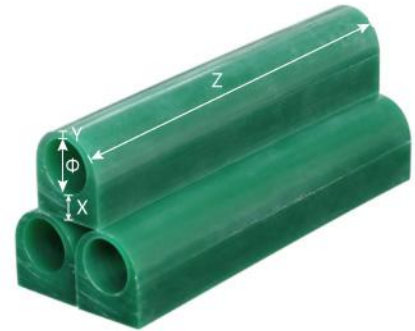

手镯蜡 Bracelet wax

单位 Unit: mm

名称 Description	型号 Model	Φ1	Φ2	X	Y	Z
手镯蜡65Q9.3-48 Bracelet wax 65Q9.3-48	T.ET.BW65Q93	65	55	9.3	4.0	48
手镯蜡70Q8.6-48 Bracelet wax 70Q8.6-48	T.ET.BW70Q86	70	60	8.6	4.0	48
手镯蜡55Q7.5-48 Bracelet wax 55Q7.5-48	T.ET.BW55Q75	55	45	7.5	4.0	48
手镯蜡57Q8-48 Bracelet wax 57Q8-48	T.ET.BW57Q8	57	47	8.0	4.0	48
手镯蜡60Q8.5-48 Bracelet wax 60Q8.5-48	T.ET.BW60Q85	60	50	8.5	3.8	48
手镯蜡62Q7.2-48 Bracelet wax 62Q7.2-48	T.ET.BW62Q72	62	52	7.2	3.2	48

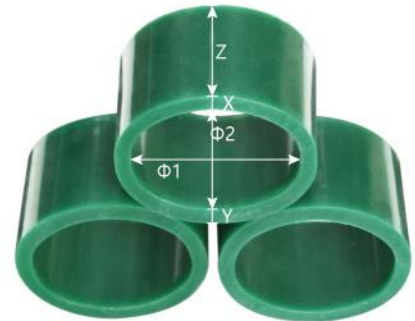

蜡片 Wax slice

单位 Unit: mm

名称 Description	型号 Model	L	W	H
蜡片3.0mm Wax slices-3 mm	T.ET.WS030	90	70	3.0
蜡片3.5mm Wax slices-3.5 mm	T.ET.WS035	90	70	3.5
蜡片4.0mm Wax slices-4.0 mm	T.ET.WS040	90	70	4.0
蜡片4.5mm Wax slices-4.5 mm	T.ET.WS045	90 </td <td>70</td> <td>4.5</td>	70	4.5
蜡片5.3mm Wax slices-5.3 mm	T.ET.WS053	90	70	5.3
蜡片6.3mm Wax slices-6.3 mm	T.ET.WS063	90	70	6.3
蜡片7.3mm Wax slices-7.3 mm	T.ET.WS073	90	70	7.3



## 树芯模 (可订制) Sprue wax mould (tailored)

代码 Model	直径 Diameter	长度 Length	树芯 Sprue
T.MK.SW0810	Φ8mm	250mm	6 Pcs
T.MK.SW0812	Φ8mm	304mm	
T.MK.SW1006	Φ10mm	152mm	
T.MK.SW1408	Φ14mm	203mm	5 Pcs
T.MK.SW1008	Φ10mm	203mm	5 Pcs
T.MK.SW1208	Φ12mm	203mm	
T.MK.SW1409	Φ14mm	228mm	
T.MK.SW1608	Φ16mm	203mm	5 Pcs
T.MK.SW1610	Φ16mm	254mm	4 Pcs
T.MK.SW1609	Φ16mm	228mm	
T.MK.SW0809	Φ8mm	203mm	
T.MK.SW2008	Φ20mm	203mm	

代码 Model	直径 Diameter	长度 Length	树芯 Sprue
T.MK.SW2009	Φ20mm	228mm	
T.MK.SW1009	Φ10mm	228mm	
T.MK.SW1209	Φ12mm	228mm	5 Pcs
T.MK.SW1208	Φ12mm	203mm	
T.MK.SW1210	Φ12mm	254mm	5 Pcs
T.MK.SW0908	Φ9mm	203mm	
T.MK.SW1611	Φ16mm	280mm	4 Pcs
T.MK.SW1108	Φ11mm	203mm	
T.MK.SW1212	Φ12mm	304mm	
T.MK.SW1410	Φ14mm	254mm	5 Pcs
T.MK.SW1412	Φ14mm	304mm	
T.MK.SW1810	Φ18mm	254mm	4 Pcs



宝石花脱模剂  
Baoshihua mould release spray  
型号 Model: T.MR.00001



蜡件 (树芯)  
Wax piece (Sprue wax)

T.CP.00017-C-A	Φ14x210mm
T.CP.00017-E-A	Φ16x210mm
T.CP.00017-G	Φ12x210mm
T.CP.00017-H	Φ18x210mm

圆形胶底座  
Round shape rubber base



代码 Model	尺寸 Size	中心孔 Centre Hole	颜色 Colour
T.RB.B0025	2.5"	Φ9mm	黑色 Black
T.RB.B0030	3"	Φ10mm	黑色 Black
T.RB.B0035	3.5"	Φ10mm	黑色 Black
T.RB.B0040	4"	Φ10mm	黑色 Black
T.RB.B0040-A	4"	Φ10mm	黑色 Black
T.RB.B0050	5"	Φ12mm	黑色 Black
T.RB.B0086	8.6"	Φ16mm	黑色 Black
T.RB.D0035	3.5"	Φ10mm	白色 White
T.RB.D0040	4"	Φ10mm	白色 White
T.RB.B0010	10"	-	黑色 Black
T.RB.B0118	11.8"	-	黑色 Black
T.RB.B0137	13.7"	-	黑色 Black
T.RB.B0157	15.7"	-	黑色 Black

锥形胶底座  
Pyramid shape rubber base



代码 Model	尺寸 Size	中心孔 Centre Hole	颜色 Colour
T.RB.A0030	3"	Φ10mm	黑色 Black
T.RB.A0035	3.5"	Φ10mm	黑色 Black
T.RB.A0040	4"	Φ10mm	黑色 Black
T.RB.A0040-A	4"	Φ10mm	绿色 Green
T.RB.A0040-B	4"	Φ10mm	蓝色 Blue
T.RB.C0040	4"	Φ10mm	白色 White
T.RB.A0050	5"	Φ12mm	黑色 Black
T.RB.A0062	6.26"	Φ15mm	黑色 Black

SUS304钢盅 (可订制) SUS304 flask (Tailored)

优质不锈钢材料, 采用特殊工艺, 使产品更加耐高温, 产品分为一次成型和焊接成型两种, 可以根据您的需求选用!

Selected stainless steel, special workmanship make flask more hightemp proof. It can be finished by 1 step, or by welding, depends on your needs.



代码 Model	尺寸 Size	壁厚 Wall thickness
T.FLA2535	2.5"×3.5"	3mm
T.FLA2504	2.5"×4"	3mm
T.FLA2505	2.5"×5"	3mm
T.FLA2506	2.5"×6"	3mm
T.FLA2507	2.5"×7"	3mm
T.FLA2508	2.5"×8"	3mm
T.FLA2509	2.5"×9"	3mm
T.FLA2510	2.5"×10"	3mm
T.FLA3035	3"×3.5"	3mm
T.FLA3004	3"×4"	3mm
T.FLA3005	3"×5"	3mm
T.FLA3006	3"×6"	3mm
T.FLA3007	3"×6"	3mm
T.FLA3008	3"×8"	3mm
T.FLA3009	3"×9"	3mm
T.FLA3010	3"×10"	3mm
T.FLA3536	3.5"×3.6"	3mm
T.FLA3504	3.5"×4"	3mm
T.FLA3505	3.5"×5"	3mm
T.FLA3506	3.5"×6"	3mm
T.FLA3507	3.5"×7"	3mm
T.FLA3508	3.5"×8"	3mm
T.FLA3509	3.5"×9"	3mm
T.FLA3510	3.5"×10"	3mm
T.FLA3511	3.5"×11"	3mm
T.FLA3512	3.5"×12"	3mm
T.FLA4035	4"×3.5"	3mm
T.FLA4004	4"×4"	3mm
T.FLA4005	4"×5"	3mm
T.FLA4055	4"×5.5"	3mm
T.FLA4006	4"×6"	3mm
T.FLA4007	4"×7"	3mm
T.FLA4075	4"×7.5"	3mm

代码 Model	尺寸 Size	壁厚 Wall thickness
T.FLA4008	4"×8"	3mm
T.FLA4009	4"×9"	3mm
T.FLA4095	4"×9.5"	3mm
T.FLA4010	4"×10"	3mm
T.FLA4011	4"×11"	3mm
T.FLA4012	4"×12"	3mm
T.FLA4013	4"×13"	3mm
T.FLA4014	4"×14"	3mm
T.FLA5004	5"×4"	3mm
T.FLA5005	5"×5"	3mm
T.FLA5006	5"×6"	3mm
T.FLA5007	5"×7"	3mm
T.FLA5008	5"×8"	3mm
T.FLA5009	5"×9"	3mm
T.FLA5010	5"×10"	3mm
T.FLD5010	5"×10"	3mm
T.FLA5011	5"×11"	3mm
T.FLA5012	5"×12"	3mm
T.FLA5013	5"×13"	3mm
T.FLA5014	5"×14"	3mm
T.FLA5016	5"×16"	3mm
T.FLA6305	6.3"×5"	3mm
T.FLA6306	6.3"×6"	3mm
T.FLA6307	6.3"×7"	3mm
T.FLA6308	6.3"×8"	3mm
T.FLA6309	6.3"×9"	3mm
T.FLA6310	6.3"×10"	3mm
T.FLA6311	6.3"×11"	3mm
T.FLA6312	6.3"×12"	3mm
T.FLA6313	6.3"×13"	3mm
T.FLA6314	6.3"×14"	3mm
T.FLA6315	6.3"×15"	3mm
T.FLA8606	8.6"×6"	3mm

代码 Model	尺寸 Size	壁厚 Wall thickness
T.FLA8607	8.6"×7"	4mm
T.FLA8608	8.6"×8"	4mm
T.FLA8609	8.6"×9"	4mm
T.FLA8610	8.6"×10"	4mm
T.FLA8611	8.6"×11"	4mm
T.FLA8612	8.6"×12"	4mm
T.FLA8613	8.6"×13"	4mm
T.FLA8614	8.6"×14"	4mm
T.FLA8615	8.6"×15"	4mm
T.FLA8616	8.6"×16"	4mm
T.FLD250250	Φ250×250mm	4mm
T.FLD254300	Φ254×300mm	4mm
T.FLD254350	Φ254×350mm	4mm
T.FLD254400	Φ254×400mm	4mm
T.FLD254450	Φ254×450mm	4mm
T.FLD300250	Φ300×250mm	4mm
T.FLD300280	Φ300×280mm	4mm
T.FLD300300	Φ300×300mm	4mm
T.FLD300350	Φ300×350mm	4mm
T.FLD300400	Φ300×400mm	4mm
T.FLD300450	Φ300×450mm	4mm
T.FLD350250	Φ350×250mm	4mm
T.FLD350300	Φ350×300mm	4mm
T.FLD350350	Φ350×350mm	4mm
T.FLD350400	Φ350×400mm	4mm
T.FLD350450	Φ350×450mm	4mm
T.FLD400250	Φ400×250mm	4mm
T.FLD400300	Φ400×300mm	4mm
T.FLD400400	Φ400×400mm	4mm
T.FLD400450	Φ400×450mm	4mm
T.FLD400500	Φ400×500mm	4mm
T.FLE300450	300×150×450mm	4mm
T.FLE350450	350×150×450mm	4mm

钢盅套 Flask cover (不含钢盅 Note: Excluding steel cups)

代码 Model	尺寸 Size	颜色 Colour
T.FL.P0409-B	4"×9"	黑色 Black
T.FL.P0410-B	4"×10"	黑色 Black
T.FL.P0405-B	4"×5"	黑色 Black
T.FL.P0406-B	4"×6"	黑色 Black
T.FL.P0407-B	4"×7"	黑色 Black
T.FL.P0408-B	4"×8"	黑色 Black
T.FL.P0411-B	4"×11"	黑色 Black
T.FL.P0412-B	4"×12"	黑色 Black
T.FL.P3508-B	3.5"×8"	黑色 Black
T.FL.P3509-B	3.5"×9"	黑色 Black
T.FL.P3510-B	3.5"×10"	黑色 Black

代码 Model	尺寸 Size	颜色 Colour
T.FL.P0508-B	5"×8"	黑色 Black
T.FL.P0509-B	5"×9"	黑色 Black
T.FL.P0510-B	5"×10"	黑色 Black
T.FL.P0511-B	5"×11"	黑色 Black
T.FL.P0512-B	5"×12"	黑色 Black
T.FL.P0513-B	5"×13"	黑色 Black
T.FL.P0514-B	5"×14"	黑色 Black
T.FL.P6308-B	6.3"×8"	黑色 Black
T.FL.P6309-B	6.3"×9"	黑色 Black
T.FL.P6310-B	6.3"×10"	黑色 Black
T.FL.P6311-B	6.3"×11"	黑色 Black

代码 Model	尺寸 Size	颜色 Colour
T.FL.P6312-B	6.3"×12"	黑色 Black
T.FL.P6313-B	6.3"×13"	黑色 Black
T.FL.P6314-B	6.3"×14"	黑色 Black
T.FL.P8608-B	8.6"×8"	黑色 Black
T.FL.P8609-B	8.6"×9"	黑色 Black
T.FL.P8610-B	8.6"×10"	黑色 Black
T.FL.P8611-B	8.6"×11"	黑色 Black
T.FL.P8612-B	8.6"×12"	黑色 Black
T.FL.P0406-W	4"×6"	白色 White
T.FL.P0409-W	4"×9"	白色 White
T.FL.P0410-W	4"×10"	白色 White



## 钢盅钳 Flask tong

代码 Model	名称 Description	重量 Weight
T.SP.QGZ001	0.65m钢盅钳 0.65m flask tong	1.4kg
T.SP.QGZ002	0.9M 钢盅钳 0.9m flask tong	1.6kg
T.SP.QGZ085-A	Φ85mm钢盅钳 Φ85mm flask tong	2.1kg
T.SP.QGZ085-B	Φ85mm钢盅钳 Φ85mm flask tong	/
T.SP.QGZ095	Φ95mm钢盅钳 Φ95mm flask tong	2.5kg
T.SP.QGZ120	钢盅钳Φ120mm Φ120mm flask tong	2.5kg
T.SP.QGZ160	Φ160mm钢盅钳 Φ160mm flask tong	2.7kg
T.SP.QGZ220	Φ220mm钢盅钳 Φ220mm flask tong	3kg
T.SP.QGZ089	3.5寸不锈钢钢盅钳 3.5 inch stainless steel flask tong	2.6kg
T.SP.QGZ101	4寸不锈钢钢盅钳 4 inch stainless steel flask tong	2.8kg
T.SP.QGZ127	5寸不锈钢钢盅钳 5 inch stainless steel flask tong	2.9kg



## 坩埚钳 Crucible tong

名称 Description	型号 Model
0.46m坩埚钳 0.46 m crucible tong	T.SP.00009
2公斤坩埚钳 (黑柄) 2 kg crucible tong (black)	Z.PMF.SP002SS
4公斤坩埚钳 4 kg crucible tong	Z.PMF.SP004SS
手提炉坩埚钳 Crucible tong for eletrical furnace	T.SP.00015
8公斤坩埚钳 8 kg crucible tong	Z.PMF.SP008SS
6公斤坩埚钳 6 kg crucible tong	Z.PMF.SP006SS
5公斤坩埚钳 5 kg crucible tong	Z.PMF.SP005SS



热电偶  
Thermo couple

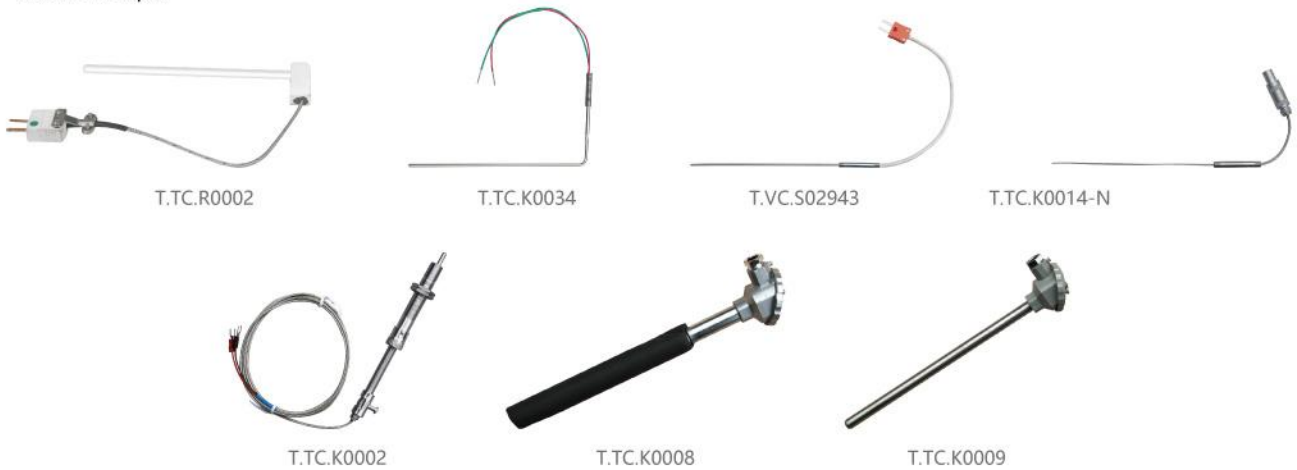

名称 Description	型号 Model	温度 Temp
K型手提炉热电偶 K type thermo couple for MF series furance	Z.P.MF.TC002	0~1300°C
K型熔金机热电偶 K type thermo couple for gold melting furance	Z.P.MF.TC001	0~1300°C
K型电炉陶瓷热电偶 K type ceramic thermo couple for button oven	T.TC.K0008	0~1300°C
K型电炉不锈钢热电偶 K type SS ceramic thermo couple for button oven	T.TC.K0009	0~1300°C
R型热电偶 (DVC) R type thermo couple	T.TC.R0002	0~1500°C
K型不锈钢热电偶 (进口) K type SS thermo couple	T.TC.K0014-N	0~1300°C
K型不锈钢热电偶 (进口) K type SS thermo couple	T.TC.K0034	0~1300°C
N型不锈钢热电偶 (进口) N type SS thermo couple	T.VC.S02943	0~1300°C

投料铲  
Shovel



名称 Description	型号 Model	包装 Package
1#投料铲 1# shovel	T.SV.00001	1 pcs
5#投料铲 5# shovel	T.SV.00002	1 pcs
手指有耳铲仔 Shovel with handle	T.SV.00003	10 pcs
小无耳铲仔 Small shovel	T.SV.00004	10 pcs
大无耳铲仔 Big shovel	T.SV.00005	10 pcs

吸水纸  
Absorbent paper

P1.0004 13×13cm  
规格: 50张/扎 Specification: 50 pcs/roll

采用纤维纸张, 有较好的透水性和强度, 水泡后不易破损, 专业用于不锈钢和铂金铸造石膏粉。

Selected special fibergood water permeability, especially used for stainless steel and platinum casting investment.



吸水纸  
Absorbent paper

P1.0002 10×10cm  
P1.0003 12×12cm

用于铂金石膏粉, 不锈钢石膏粉。采用特种定制纸张, 有很强的水渗透性, 并可以保持良好的强度, 确保石膏盘不会破损和渗漏。

Suitable for platinum casting investment, stainless steel casting investment. Special paper, good water permeability, strong enough to prevent damage and permeability of flask.



美纹胶纸  
Masking tape

代码 Model	尺寸 Size	包装 Package
T.CG.00130-8	8mm	280 Rolls/Box
T.CG.00130-9	9mm	260 Rolls/Box
T.CG.00130	10mm	240 Rolls/Box
T.CG.00130-12	12mm	200 Rolls/Box
T.CG.00130-15	15mm	160 Rolls/Box
T.CG.00130-18	18mm	130 Rolls/Box
T.CG.00150	20mm	120 Rolls/Box
T.CG.00150-24	24mm	100 Rolls/Box
T.CG.00202	30mm	80 Rolls/Box
T.CG.00202-36	36mm	70 Rolls/Box
T.CG.00152	40mm	60 Rolls/Box
T.CG.00152-45	45mm	60 Rolls/Box
T.CG.00065	16.5mm	90 Rolls/Box
T.CG.00152	40mm	50 Rolls/Box



车花胶  
Adhesive tape

代码 Model	尺寸 Size	包装 Package
M.FM.P0008	10mm	138 Pcs/Pack
M.FM.P0007	15mm	96 Pcs/Pack
M.FM.P0001	25mm	60 Pcs/Pack
M.FM.P0041	50mm	30 Pcs/Pack



工匠台采用实木精心打造，表面采用透明环保清漆，适用于执模、微镶等首饰加工，人体工学设计，高档大方，坚固耐用，实用性强。可根据自身需求订制，木质可选白蜡木、橡木等。

The benches are carefully made of solid wood, the surface is transparent and environmentally friendly paint and suitable for jewelry processing such as benching and stone setting, ergonomic design, high-grade and generous, strong and durable, practical. It could be customized according to your requirements, wood can choose ash wood, oak and so on.



T.GI.00224  
尺寸 Size: 1770×600×1070mm

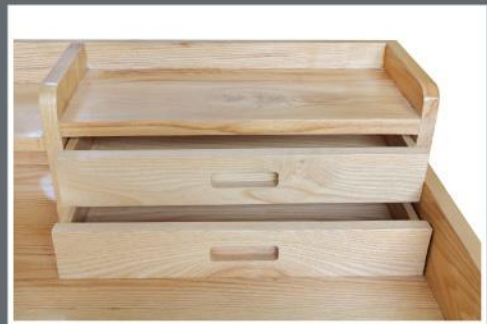

T.GI.00216  
尺寸 Size: 1570×630×1070mm

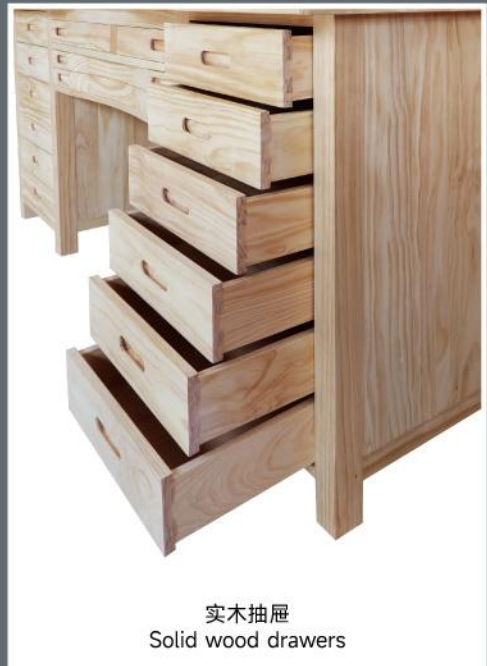

实木抽屉  
Solid wood drawers

工匠台采用实木精心打造，表面采用透明环保清漆，适用于执模、微镶等首饰加工，人体工学设计，高档大方，坚固耐用，实用性强。可根据自身需求订制，木质可选白蜡木、橡木等。

The benches are carefully made of solid wood, the surface is transparent and environmentally friendly paint and suitable for jewelry processing such as benching and stone setting, ergonomic design, high-grade and generous, strong and durable, practical. It could be customized according to your requirements, wood can choose ash wood, oak and so on.

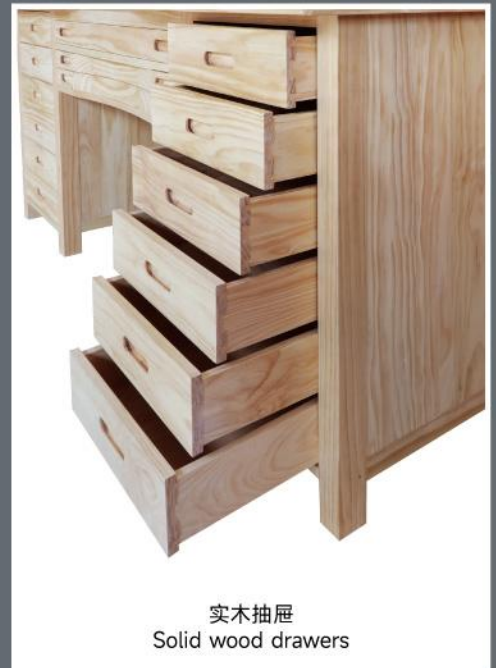

T.GI.00224-B

尺寸 Size: L1770×W700×H1080mm

工匠台采用实木精心打造，表面采用透明环保清漆，适用于执模、微镶等首饰加工，人体工学设计，高档大方，坚固耐用，实用性强。可根据自身需求订制，木质可选白蜡木、橡木等。

The benches are carefully made of solid wood, the surface is transparent and environmentally friendly paint and suitable for jewelry processing such as benching and stone setting, ergonomic design, high-grade and generous, strong and durable, practical. It could be customized according to your requirements, wood can choose ash wood, oak and so on.



铜手柄  
Copper handle



T.GI.00226

尺寸 Size: L1430×W500×H1050mm

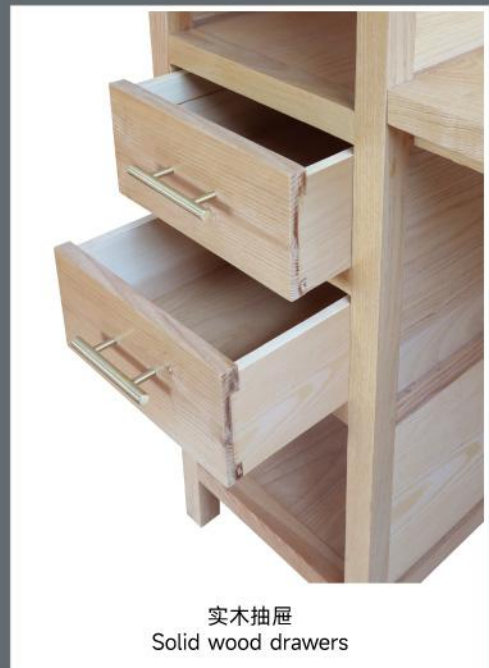

实木抽屉  
Solid wood drawers



工匠台采用实木精心打造，表面采用透明环保清漆，适用于执模、微镶等首饰加工，人体工学设计，高档大方，坚固耐用，实用性强。可根据自身需求订制，木质可选白蜡木、橡木等。

The benches are carefully made of solid wood, the surface is transparent and environmentally friendly paint and suitable for jewelry processing such as benching and stone setting, ergonomic design, high-grade and generous, strong and durable, practical. It could be customized according to your requirements, wood can choose ash wood, oak and so on.



铜手柄  
Copper handle



T.GI.00227

尺寸 Size: L1600×W500×H1050mm



实木抽屉  
Solid wood drawers



- 设计用于移动显微镜的设置和雕刻工作站最多可安装4个容器，高度可调节
  - 可选内置单用户提取器
  - 5D扶手
  - 带块系统的技术导轨
  - 各种手柄固定器
- Setter and engraver workstation designed for moveable microscope up to 4 containers in height-adjustable manner
  - Optional built-in single-user extraction
  - 5D armrests
  - Technical rail with block system
  - Various holders for handpieces



电动调节升降  
Electric regulating lifting



T.GI.70001



中间小型抽屉  
Small drawer in the middle

**可选配 CONFIGURABLE**

自由选择 - 抽屉容器和侧盖  
Free selection - drawer containers & sidecover



非常稳定，高度可调的框架  
VERY STABLE, HEIGHTADJUSTABLE FRAME



实木抽屉  
Solid wood drawers

尺寸 Size: L1900×W800×H1250mm

- 设计用于移动显微镜的设置和雕刻工作站最多可安装4个容器，高度可调节
  - 可选内置单用户提取器
  - 5D扶手
  - 带块系统的技术导轨
  - 各种手柄固定器
- Setter and engraver workstation designed for moveable microscope up to 4 containers can be attached in height-adjustable manner
  - Optional built-in single-user extraction
  - 5D armrests
  - Technical rail with block system
  - Various holders for handpieces



T.GI.70008

**可选配 CONFIGURABLE**

自由选择 - 抽屉容器和侧盖  
Free selection - drawer containers & sidecover



非常稳定，高度可调的框架 (850-1250mm)  
VERY STABLE, HEIGHTADJUSTABLE FRAME



电动调节升降  
Electric regulating lifting



中间小型伸缩托盘  
Small retractable tray in the middle

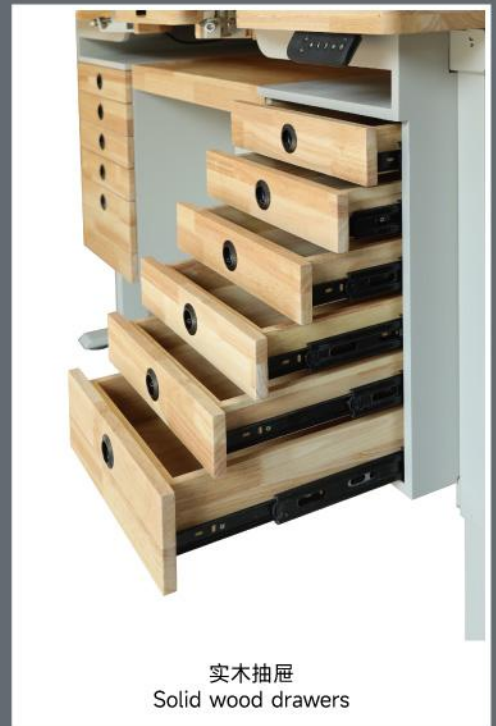

实木抽屉  
Solid wood drawers

尺寸 Size: L1450×W650×H1250mm

- 设计用于移动显微镜的设置和雕刻工作站最多可安装4个容器，高度可调节
  - 可选内置单用户提取器
  - 5D扶手
  - 带块系统的技术导轨
  - 各种手柄固定器
- Setter and engraver workstation designed for moveable microscope up to 4 containers can be attached in height-adjustable manner
  - Optional built-in single-user extraction
  - 5D armrests
  - Technical rail with block system
  - Various holders for handpieces



T.GI.70002



电动调节升降  
Electric regulating lifting



中间小型抽屉  
Small drawer in the middle



实木抽屉  
Solid wood drawers

**可选配 CONFIGURABLE**

自由选择 - 抽屉容器和侧盖  
Free selection - drawer containers & sidecover



非常稳定，高度可调的框架 (850-1250mm)  
VERY STABLE, HEIGHT ADJUSTABLE FRAME

尺寸 Size: L1450×W650×H1250mm

- 设计用于移动显微镜的设置和雕刻工作站最多可安装4个容器，高度可调节
  - 可选内置单用户提取器
  - 5D扶手
  - 带块系统的技术导轨
  - 各种手柄固定器
- Setter and engraver workstation designed for moveable microscope up to 4 containers can be attached in height-adjustable manner
  - Optional built-in single-user extraction
  - 5D armrests
  - Technical rail with block system
  - Various holders for handpieces



T.GI.70003

**可选配 CONFIGURABLE**

自由选择 - 抽屉容器和侧盖  
Free selection - drawer containers & sidecover



非常稳定，高度可调的框架 (850-1250mm)  
VERY STABLE, HEIGHTADJUSTABLE FRAME



电动调节升降  
Electric regulating lifting



中间小型抽屉  
Small drawer in the middle



实木抽屉  
Solid wood drawers

尺寸 Size: L1600×W850×H1250mm

- 设计用于移动显微镜的设置和雕刻工作站最多可安装4个容器，高度可调节
  - 可选内置单用户提取器
  - 5D扶手
  - 带块系统的技术导轨
  - 各种手柄固定器
- Setter and engraver workstation designed for moveable microscope up to 4 containers can be attached in height-adjustable manner
  - Optional built-in single-user extraction
  - 5D armrests
  - Technical rail with block system
  - Various holders for handpieces



T.GI.70005

**可选配 CONFIGURABLE**

自由选择 - 抽屉容器和侧盖  
Free selection - drawer containers & sidecover



非常稳定，高度可调的框架 (850-1250mm)  
VERY STABLE, HEIGHT ADJUSTABLE FRAME



电动调节升降  
Electric regulating lifting



中间小型收纳空间  
Small storage space in the middle



实木抽屉  
Solid wood drawers

尺寸 Size: L1450×W650×H1250mm

- 设计用于移动显微镜的设置和雕刻工作站最多可安装4个容器，高度可调节
  - 可选内置单用户提取器
  - 5D扶手
  - 带块系统的技术导轨
  - 各种手柄固定器
- Setter and engraver workstation designed for moveable microscope up to 4 containers can be attached in height-adjustable manner
  - Optional built-in single-user extraction
  - 5D armrests
  - Technical rail with block system
  - Various holders for handpieces



T.GI.70007

**可选配 CONFIGURABLE**

自由选择 - 抽屉容器和侧盖  
Free selection - drawer containers & sidecover



非常稳定，高度可调的框架 (850-1250mm)  
VERY STABLE, HEIGHTADJUSTABLE FRAME



电动调节升降  
Electric regulating lifting



中间小型抽屉  
Small drawer in the middle



实木抽屉  
Solid wood drawers

尺寸 Size: L1450×W650×H1250mm

- 设计用于移动显微镜的设置和雕刻工作站最多可安装4个容器，高度可调节
- 可选内置单用户提取器
- 带块系统的技术导轨
- 各种手柄固定器
- Setter and engraver workstation designed for moveable microscope up to 4 containers can be attached in height-adjustable manner
- Optional built-in single-user extraction
- Technical rail with block system
- Various holders for handpieces



T.GI.70004



电动调节升降  
Electric regulating lifting



中间小型收纳空间  
Small storage space in the middle

**可选配 CONFIGURABLE**

自由选择 - 抽屉容器和侧盖  
Free selection - drawer containers & sidecover



非常稳定，高度可调的框架 (850-1250mm)  
VERY STABLE, HEIGHT ADJUSTABLE FRAME



实木抽屉  
Solid wood drawers

尺寸 Size: L1450×W650×H1250mm

- 设计用于移动显微镜的设置和雕刻工作站最多可安装4个容器，高度可调节
- 可选内置单用户提取器
- 带块系统的技术导轨
- 各种手柄固定器
- Setter and engraver workstation designed for moveable microscope up to 4 containers can be attached in height-adjustable manner
- Optional built-in single-user extraction
- Technical rail with block system
- Various holders for handpieces



T.GI.70006

**可选配 CONFIGURABLE**

自由选择 - 抽屉容器和侧盖  
Free selection - drawer containers & sidecover



非常稳定，高度可调的框架 (850-1250mm)  
VERY STABLE, HEIGHTADJUSTABLE FRAME



电动调节升降  
Electric regulating lifting



中间小型收纳空间  
Small storage space in the middle



实木抽屉  
Solid wood drawers

尺寸 Size: L1450×W650×H1250mm



注蜡台  
Wax injection table

T.GI.70009

尺寸 Size: L2000×W1200×H1520mm



6个实木抽屉  
Six solid wood drawers

可订制  
Tailored



工作台  
Bench

T.GI.00206  
990×600×900mm



木架微镶台-A  
Micro setting bench

T.GI.00012  
790×480×910mm



不锈钢功夫台  
Stainless steel desk

T.GI.00191  
800×400×1200mm



功夫台  
Desk

T.GI.00050  
800×400×1200mm



木凳子  
Wooden stool

T.GI.00053  
320×230×450mm



大力士戒指扩大器  
Super strong ring enlarger

M.RS.00001  
330×95×45mm 1.2kg



单头戒指扩缩器  
Single head ring enlarger & reducer

M.RS.00002  
HK 6#-36# 450×235×195mm 9.8kg



单头戒指扩缩器  
Single head ring enlarger & reducer

M.RS.00002-A  
405×235×195mm 9.5kg



双头戒指扩缩器  
Double head ring enlarger & reducer

M.RS.00003  
US 4#-14# 315×210×165mm 9.8kg



双头戒指扩缩器  
Double head ring enlarger & reducer

M.RS.00003-B  
HK 6#-36# 315×210×165mm 9.8kg



韩式戒指扩大器  
Korean stype ring enlarger

M.RS.00012  
280×125×140mm 3.5kg



简易扩大器  
Simple ring enlarger

M.RS.00015



多功能戒指扩大器  
Multi-function ring enlarger

M.RS.00013 130×180×250mm 8.8kg



手动360度戒指扩大器  
Manual 360°C ring enlarger

M.RS.00014



12mm, 14mm, 16mm, 20mm, 22mm  
90°C, 45°C

戒指折弯器  
Ring Bender  
M.RS.00006



手镯扩大器  
Matt wax ring stick  
M.RS.00004



50mm, 52mm, 54mm, 56mm, 58mm  
60mm, 62mm, 64mm, 66mm, 68mm

圆形阶梯手镯扩大器  
Matt wax ring stick  
M.RS.00007 178×260mm 11KG



42-50mm, 44-52mm, 46-54mm, 48-56  
50-58mm, 52-60mm, 54-62mm, 56-64

椭圆形阶梯手镯扩大器  
Matt wax ring stick  
M.RS.00008



手镯戒指卷圆一体机  
Bracelet ring rolling machine  
M.RS.00010-A  
183×100×290mm 7.5kg



手镯戒指卷圆一体机  
Bracelet ring rolling machine  
M.RS.00010-B  
183×100×290mm 7.5kg



手镯戒指卷圆一体机  
Bracelet ring rolling machine  
M.RS.00010-C  
183×100×290mm 8.2kg

## 山特斯镊子 Santus tweezer

1、优质不锈钢锻造，防锈耐磨硬度强。

2、人体工学工艺，拿捏处比尾部厚，使用舒适手感好，可用于夹镊精密的电子元件，燕窝，宝石等细密物件。

1. High quality stainless steel forging, rust proof, wear-resistant, and strong hardness.

2. Ergonomic craftsmanship, with a thicker grip than the tail, providing a comfortable and tactile feel. It can be used to clamp precision electronic components, bird's nests, gemstones, and other delicate objects.



**ST-10**  
L120×W10mm  
T.TW.ST010



**ST-11**  
L120×W10mm  
T.TW.ST011



**ST-12**  
L120×W10mm  
T.TW.ST012



**ST-13**  
L120×W10mm  
T.TW.ST013



**ST-14**  
L120×W10mm  
T.TW.ST014



**ST-15**  
L120×W10mm  
T.TW.ST015



**ST-16**  
L120×W10mm  
T.TW.ST016



**ST-18**  
L120×W10mm  
T.TW.ST018

## 304防碘伏镊子 304 iodine resistant forceps

采用锯齿防滑槽设计，夹力更强有效防止夹持中物品掉落。

Adopting a serrated anti slip groove design, the clamping force is stronger and effectively prevents objects from falling during clamping.

代码 Model	长度 Length
A T.TW.00050-1	125mm
B T.TW.00050-2	140mm
C T.TW.00050-3	160mm
D T.TW.00050-4	180mm
E T.TW.00050-5	200mm
F T.TW.00050-6	250mm
G T.TW.00050-7	300mm

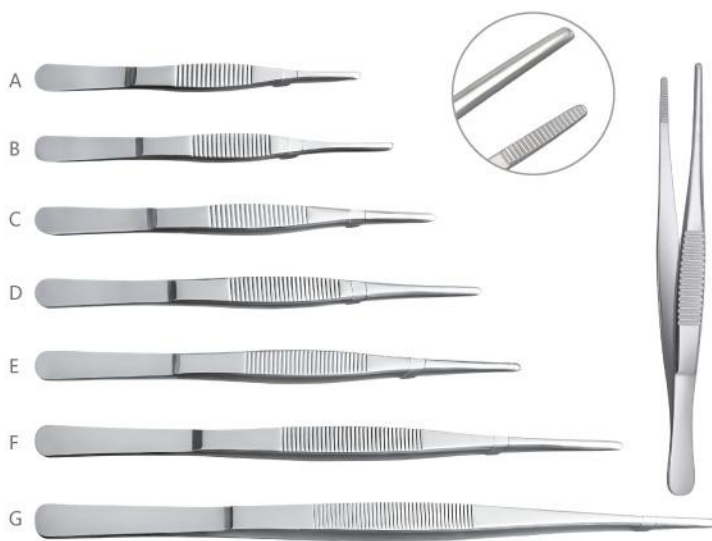

## 加厚不锈钢直尖头镊子 Thick stainless steel straightpointed tweezers

代码 Model	长度 Length
T.TW.00051-1	125mm
T.TW.00051-2	140mm
T.TW.00051-3	160mm
T.TW.00051-4	180mm
T.TW.00051-5	200mm
T.TW.00051-6	250mm

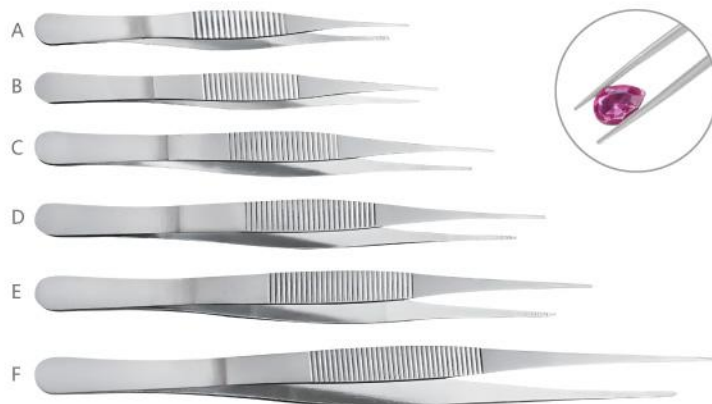

AA夹  
AA tweezer



5" T.TW.00001

6" T.TW.00002

8" T.TW.00003

焊夹  
Soldering clamp



6" T.TW.00020-6

8" T.TW.00020

10" T.TW.00013



弯嘴镊子  
Curved mouth tweezers  
T.TW.00036



12寸夹金夹  
12" clamp for gold  
T.TW.00021



14寸夹金夹  
14" clamp for gold  
T.TW.00014



扣链夹  
Clamp for button and chain  
T.TW.00023



曲咀反弹夹  
Bend mouth tweezers  
T.TW.00006



平咀反弹夹  
Flat mouth tweezers  
T.TW.00010



带底座焊夹  
With base welding clip  
T.TW.00033



带底座焊夹  
With base welding clip  
T.TW.00033-b



8字夹  
Cross locking tweezers  
T.TW.00022



带铲AA夹  
AA tweezer shovel  
T.TW.00035



万向双头夹  
Cross locking tweezers  
T.TW.00037

日本三山剪钳GN-200  
Japan GN-200 3 peaks piler

型号: T.SP.QGN200  
切割能力: 硬钢线1.5mm、铁线4.0mm、铜线4.0mm  
产品重量: 255g/把 | 包装尺寸: 263x81x20mm | 6把/盒

Model: T.SP.QGN200  
Cutting ability: 1.5mm hard steel wire, 4.0mm iron wire, 4.0mm copper wire  
Product weight: 255g/Pcs | Packaging size: 263x81x20mm | 6 Pcs/Box



日本三山剪钳GN-200J  
Japan GN-200J 3 peaks piler

型号: T.SP.QGN200J  
切割能力: 硬钢线0.5mm、铁线2.0mm、铜线2.0mm  
产品重量: 255g/把 | 包装尺寸: 263x81x20mm | 6把/盒

Model: T.SP.QGN200J  
Cutting ability: 0.5mm hard steel wire, 2.0mm iron wire, 2.0mm copper wire  
Product weight: 255g/Pcs | Packaging size: 263x81x20mm | 6 Pcs/Box



日本三山剪钳EC-200  
Japan EC-200 3 peaks piler

型号: T.SPEC200  
切割能力: 硬钢线1.5mm、铁线4.0mm、铜线4.0mm  
产品重量: 265g/把 | 包装尺寸: 263x81x20mm | 6把/盒

Model: T.SPEC200  
Cutting ability: 1.5mm hard steel wire, 4.0mm iron wire, 4.0mm copper wire  
Product weight: 265g/Pcs | Packaging size: 263x81x20mm | 6 Pcs/Box



日本三山剪钳GC-200  
Japan GC-200 3 peaks piler

型号: T.SP.QGC200  
切割能力: 硬钢线1.5mm、铁线4.0mm、铜线4.0mm  
产品重量: 270g/把 | 包装尺寸: 263x81x20mm | 6把/盒

Model: T.SP.QGC200  
Cutting ability: 1.5mm hard steel wire, 4.0mm iron wire, 4.0mm copper wire  
Product weight: 270g/Pcs | Packaging size: 263x81x20mm | 6 Pcs/Box



日本三山水口剪钳PNP-150G  
Japan 3 peaks piler PNP-150G

型号: T.SP.QPNP150G  
切割能力: 合成树脂塑料5.0mm  
产品重量: 150g/把 | 包装尺寸: 207x70x15mm | 6把/盒

Model: T.SP.QPNP150G  
Cutting ability: Synthetic resin plastic 5.0mm  
Product weight: 150g/Pcs | Packaging size: 207x70x15mm | 6 Pcs/Box



日本三山水口剪钳PNP-125  
Japan 3 peaks piler PNP-125

型号: T.SP.QPNP125  
切割能力: 合成树脂塑料5.0mm  
产品重量: 95g/把 | 包装尺寸: 179x70x14mm | 6把/盒

Model: T.SP.QPNP125  
Cutting ability: Synthetic resin plastic 5.0mm  
Product weight: 95g/Pcs | Packaging size: 179x70x14mm | 6 Pcs/Box



### 三山水口钳190G Japan 3 peaks piler 190G

型号: T.SP.Q190G  
切割能力: 合成树脂塑料8.0mm  
产品重量: 220g/把 | 包装尺寸: 256x77x20mm | 6把/盒

Model: T.SP.Q190G  
Cutting ability: Synthetic resin plastic 8.0mm  
Product weight: 220g/Pcs | Packaging size: 256x77x20mm | 6 Pcs/Box



### 日本三山白色圆嘴钳 Japan white round nose pliers

型号: T.SP.QSP27  
切割能力: 合成树脂塑料8.0mm  
产品重量: 150g/把 | 包装尺寸: 207x70x15mm | 6把/盒

Model: T.SP.QSP27  
Cutting ability: Synthetic resin plastic 8.0mm  
Product weight: 150g/Pcs | Packaging size: 207x70x15mm | 6 Pcs/Box



### 马牌水口剪钳PL-726 KEIBA side sprue cutter PL-726

型号: T.SP.QPL726  
切割能力: 剪水口或者塑胶5.0mm  
产品重量: 130g/把 | 包装尺寸: 270x80x5mm | 6把/盒

Model: T.SP.QPL726  
Cutting ability: Cutting nozzle or plastic 5.0mm  
Product weight: 130g/Pcs | Packaging size: 270x80x5mm | 6 Pcs/Box



### 马牌剪钳PL-717 KEIBA side sprue cutter PL-717

型号: T.SP.QPL717  
切割能力: 剪水口或者塑胶6.0mm  
产品重量: 215g/把 | 包装尺寸: 270x60x7mm | 6把/盒

Model: T.SP.QPL717  
Cutting ability: Cutting nozzle or plastic 6.0mm  
Product weight: 215g/Pcs | Packaging size: 270x60x7mm | 6 Pcs/Box



### 马牌水口剪钳PL-725 KEIBA side sprue cutter PL-725

型号: T.SP.QPL725  
切割能力: 剪水口或者塑胶4.0mm  
产品重量: 85g/把 | 包装尺寸: 270x60x7mm | 6把/盒

Model: T.SP.QPL725  
Cutting ability: Cutting nozzle or plastic 4.0mm  
Product weight: 85g/Pcs | Packaging size: 270x60x7mm | 6 Pcs/Box



### 白柄剪 EN-115 White handle cutter EN-115

型号: T.SP.QT004  
切割能力: 铜软线0.13-1.2mm  
产品重量: 50g/把 | 包装尺寸: 180x65mm | 6把/盒

Model: T.SP.QT004  
Cutting ability: Copper flexible wire 0.13-1.2mm  
Product weight: 50g/Pcs | Packaging size: 180x65mm | 6 Pcs/Box



**红柄剪 ENI-100**  
**Red handle cutter ENI-100**

型号: T.SP.QT101  
切割能力: 铜软线0.13-1.2mm  
产品重量: 50g/把 | 包装尺寸: 180x65mm | 6把/盒

Model: T.SP.QT101  
Cutting ability: Copper flexible wire 0.13-1.2mm  
Product weight: 50g/Pcs | Packaging size: 180x65mm | 6 Pcs/Box



**斜嘴钳 NP-125PH-S**  
**Side sprue cutter NP-125PH-S**

型号: T.SP.NP125PH  
切割能力: 铁线1.5mm, 铜线2.6mm, 多股胶合线2.0mm  
产品重量: 100g/把 | 包装尺寸: 179x70x20mm | 6把/盒

Model: T.SP.NP125PH  
Cutting ability: 1.5mm iron wire, 2.6mm copper wire, 2.0mm multi strand glued wire  
Product weight: 100g/Pcs | Packaging size: 179x70x20mm | 6 Pcs/Box



**斜嘴钳 NP-150PH-S**  
**Side sprue cutter NP-150PH-S**

型号: T.SP.NP150PH  
切割能力: 铁线1.9mm, 铜线3.2mm, 多股胶合线2.0mm  
产品重量: 170g/把 | 包装尺寸: 207x70x20mm | 6把/盒

Model: T.SP.NP150PH  
Cutting ability: 1.9mm iron wire, 3.2mm copper wire, 2.0mm multi strand glued wire  
Product weight: 170g/Pcs | Packaging size: 207x70x20mm | 6 Pcs/Box



**水口钳 AP-125G-S**  
**Side sprue cutter AP-125G-S**

型号: T.SP.AP125G  
切割能力: 合成树脂塑料5.0mm  
产品重量: 105g/把 | 包装尺寸: 179x70x18mm | 6把/盒

Model: T.SP.AP125G  
Cutting ability: Synthetic resin plastic 5.0mm  
Product weight: 105g/Pcs | Packaging size: 179x70x18mm | 6 Pcs/Box



**水口钳 AP-150G-S**  
**Side sprue cutter AP-150G-S**

型号: T.SP.AP150G  
切割能力: 合成树脂塑料5.0mm  
产品重量: 155g/把 | 包装尺寸: 207x70x19mm | 6把/盒

Model: T.SP.AP150G  
Cutting ability: Synthetic resin plastic 5.0mm  
Product weight: 155g/Pcs | Packaging size: 207x70x19mm | 6 Pcs/Box



**山特斯尖嘴钳 ST-502F**  
**Santus round nose pliers ST-502F**

型号: T.SP.QST502F  
特点: 无牙, 夹持不损坏物件  
总长度: 133mm | 6把/盒

Model: T.SP.QST502F  
Features: No teeth, no damage to objects during clamping  
Total length: 133mm | 6 Pcs/Box



**山特斯5寸斜嘴钳ST-A04H**  
Santus side sprue cutter ST-A04H

型号: T.SPQSTA04H  
切割能力: 铜软线0.13-1.2mm  
总长度: 120mm

Model: T.SPQSTA04H  
Cutting ability: 1.2mm in plastic water outlet and soft copper wire  
Total length: 120mm



**山特斯5寸斜嘴钳ST-A05H**  
Santus side sprue cutter ST-A05H

型号: T.SPQSTA05H  
切割能力: 铜软线0.13-1.2mm  
总长度: 127mm

Model: T.SPQSTA05H  
Cutting ability: 1.2mm in plastic water outlet and soft copper wire  
Total length: 127mm



**山特斯5寸斜嘴钳ST-A15H**  
Santus side sprue cutter ST-A15H

型号: T.SPQSTA15H  
切割能力: 铜软线0.13-1.2mm  
总长度: 125mm

Model: T.SPQSTA15H  
Cutting ability: 1.2mm in plastic water outlet and soft copper wire  
Total length: 125mm



**山特斯有牙弯嘴钳ST-503**  
Santus curved nose pliers ST-503

型号: T.SPQST503A  
功能范围: 软铜线1.2mm, 剪线绕线  
总长度: 132mm

Model: T.SPQST503A  
Functional scope: 1.2mm soft copper wire, wire cutting and winding  
Total length: 132mm



**山特斯无牙弯嘴钳ST-503**  
Santus curved nose pliers ST-503

型号: T.SPQST503B  
功能范围: 软铜线1.2mm, 剪线绕线  
总长度: 132mm

Model: T.SPQST503B  
Functional scope: 1.2mm soft copper wire, wire cutting and winding  
Total length: 132mm



**山特斯圆嘴钳ST-5HF**  
Santus round nose pliers ST-503

型号: T.SPQST5HF  
功能范围: 软铜线1.2mm, 剪线绕线  
总长度: 135mm | 6把/盒

Model: T.SPQST5HF  
Functional scope: 1.2mm soft copper wire, wire cutting and winding  
Total length: 135mm | 6 Pcs/Box



**国产无牙尖嘴钳MTC-15PS**  
**Flat nose piler MTC-15PS**

型号: T.SP.QT022  
特点: 无牙, 夹持不损坏物件  
总长度: 123mm | 6把/盒

Model: T.SP.QT022  
Features: No teeth, no damage to objects during clamping  
Total length: 123mm | 6 Pcs/Box



**无牙尖嘴钳MTC-15PS**  
**Flat nose piler MTC-15PS**

型号: T.SP.QMTC15PS  
特点: 无牙, 夹持不损坏物件  
总长度: 123mm | 6把/盒

Model: T.SP.QMTC15PS  
Features: No teeth, no damage to objects during clamping  
Total length: 123mm | 6 Pcs/Box



**国产斜口钳MTC-2D**  
**Flat nose piler MTC-2D**

型号: T.SP.QT037  
切割能力: 铜软线2.0mm  
总长度: 115mm | 6把/盒

Model: T.SP.QT037  
Features: 2.0mm in plastic water outlet and soft copper wire  
Total length: 115mm | 6 Pcs/Box



**斜口钳MTC-2D**  
**Flat nose piler MTC-2D**

型号: T.SP.QMTC2D  
切割能力: 铜软线2.0mm  
总长度: 115mm | 6把/盒

Model: T.SP.QMTC2D  
Features: 2.0mm in plastic water outlet and soft copper wire  
Total length: 115mm | 6 Pcs/Box



**斜口钳MTC-21**  
**Flat nose piler MTC-21**

型号: T.SP.QMTC21  
切割能力: 铜软线1.8mm  
总长度: 125mm | 6把/盒

Model: T.SP.QMTC21  
Features: 1.8mm in plastic water outlet and soft copper wire  
Total length: 125mm | 6 Pcs/Box



**斜口钳MTC-22**  
**Flat nose piler MTC-22**

型号: T.SP.QMTC2D  
切割能力: 铜软线2.0mm  
总长度: 150mm | 6把/盒

Model: T.SP.QMTC2D  
Features: 2.0mm in plastic water outlet and soft copper wire  
Total length: 150mm | 6 Pcs/Box



**鹿牌尖嘴钳**  
**ANTILOPE lat nose piler**

型号: T.SPQLP001  
特点: 无牙, 夹持不损坏物件  
总长度: 130mm | 产品重量: 75g/把 | 20把/盒

Model: T.SPQLP001  
Features: No teeth, no damage to objects during clamping  
Total length: 130mm | Product weight: 75g/Pcs | 20 Pcs/Box



**鹿牌圆嘴钳**  
**ANTILOPE round nose piler**

型号: T.SPQLP002  
特点: 无牙, 夹持不损坏物件  
总长度: 130mm | 产品重量: 80g/把 | 20把/盒

Model: T.SPQLP002  
Features: No teeth, no damage to objects during clamping  
Total length: 130mm | Product weight: 80g/Pcs | 20 Pcs/Box



**鹿牌平嘴钳**  
**ANTILOPE flat nose pliers**

型号: T.SPQLP003  
特点: 无牙, 夹持不损坏物件  
总长度: 130mm | 产品重量: 80g/把 | 20把/盒

Model: T.SPQLP003  
Features: No teeth, no damage to objects during clamping  
Total length: 130mm | Product weight: 80g/Pcs | 20 Pcs/Box



**箭牌尖嘴钳**  
**Wrigley pointed nose pliers**

型号: T.SPQJP001  
特点: 无牙, 夹持不损坏物件  
总长度: 130mm | 产品重量: 75g/把 | 10把/盒

Model: T.SPQJP001  
Features: No teeth, no damage to objects during clamping  
Total length: 130mm | Product weight: 75g/Pcs | 10 Pcs/Box



**箭牌圆嘴钳**  
**Wrigley round nose pliers**

型号: T.SPQJP003  
特点: 无牙, 夹持不损坏物件  
总长度: 130mm | 产品重量: 75g/把 | 10把/盒

Model: T.SPQJP003  
Features: No teeth, no damage to objects during clamping  
Total length: 130mm | Product weight: 75g/Pcs | 10 Pcs/Box



**箭牌平嘴钳**  
**Wrigley flat nose pliers**

型号: T.SPQJP002  
特点: 无牙, 夹持不损坏物件  
总长度: 130mm | 产品重量: 75g/把 | 10把/盒

Model: T.SPQJP002  
Features: No teeth, no damage to objects during clamping  
Total length: 130mm | Product weight: 75g/Pcs | 10 Pcs/Box



剪钳 Pliers



型号 Model: T.SPS166  
总长度 Total length: 120mm  
重量 Weight: 63g/Pcs



型号 Model: T.SPS190-14  
总长度 Total length: 150mm  
重量 Weight: 135g/Pcs



型号 Model: T.SPS206  
总长度 Total length: 140mm  
重量 Weight: 90g/Pcs



型号 Model: T.SPS192  
总长度 Total length: 130mm  
重量 Weight: 73g/Pcs



型号 Model: T.SPS200  
总长度 Total length: 130mm  
重量 Weight: 83g/Pcs



型号 Model: T.SPS208  
总长度 Total length: 135mm  
重量 Weight: 82g/Pcs



型号 Model: T.SPS209  
总长度 Total length: 130mm  
重量 Weight: 80g/Pcs



型号 Model: T.SPS210  
总长度 Total length: 135mm  
重量 Weight: 77g/Pcs



型号 Model: T.SPS272  
总长度 Total length: 140mm  
重量 Weight: 90g/Pcs



型号 Model: T.SP.281  
总长度 Total length: 173mm  
重量 Weight: 133g/Pcs



型号 Model: T.SPS380FF  
总长度 Total length: 125mm  
重量 Weight: 75g/Pcs



型号 Model: T.SPS380RF  
总长度 Total length: 120mm  
重量 Weight: 57g/Pcs



型号 Model: T.SP.S380RR  
总长度 Total length: 120mm  
重量 Weight: 56g/Pcs



型号 Model: T.SP.381  
总长度 Total length: 165mm  
重量 Weight: 123g/Pcs



型号 Model: T.SPS382  
总长度 Total length: 140mm  
重量 Weight: 147g/Pcs



型号 Model: T.SPS383  
总长度 Total length: 150mm  
重量 Weight: 150g/Pcs



型号 Model: T.SPS545-3  
总长度 Total length: 135mm  
重量 Weight: 98g/Pcs



型号 Model: T.SP281  
总长度 Total length: 173mm  
重量 Weight: 133g/Pcs



型号 Model: T.SPS196  
总长度 Total length: 145mm  
重量 Weight: 134g/Pcs



型号 Model: T.SPS322  
总长度 Total length: 145mm  
重量 Weight: 138g/Pcs



型号 Model: T.SPS380RR  
总长度 Total length: 120mm  
重量 Weight: 56g/Pcs



型号 Model: T.SPQT052  
总长度 Total length: 150mm  
重量 Weight: 110g/Pcs



韩国SB206剪钳  
Korea SB 206 piler  
型号 Model : T.SP.QSB206  
总长度 Total length: 160mm



韩国SB203剪钳 (尾部平)  
Korea SB 203 piler with flat end  
型号 Model : T.SP.QSB203-1  
总长度 Total length: 195mm



韩国SB203剪钳 (尾部圆)  
Korea SB 203 piler with round end  
型号 Model : T.SP.QSB203-2  
总长度 Total length: 195mm



弹簧平钳  
Spring pliers  
型号 Model : T.SP.QT005-A  
总长度 Total length: 150mm



弹簧平钳  
Spring pliers  
型号 Model : T.SP.QT005-B  
总长度 Total length: 150mm

断线钳  
Bolt cutter



42" T.SP.QT010



48" T.SP.00078

型号 Model	总长度 Total length	手柄长度 Total length	钳头宽度 Total length	剪切范围 Total length
T.SP.QT010	105cm	86cm	11.8cm	14cm
T.SP.00078	120cm	100cm	11.8cm	16cm



气动剪钳HS-35P  
Side sprue cutter  
型号 Model: T.SP.QT028

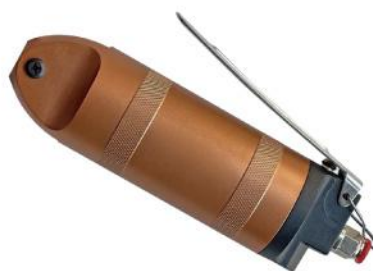

气动剪钳H-30T  
Side sprue cutter  
型号 Model: T.SP.QT059



切割能力Cutting ability  
铁线2.8mm, 铜线3.3mm  
2.8mm iron wire, 3.3mm copper wire

气动剪钳刀头  
Side sprue cutter  
型号 Model: T.SP.QT029

进口电动剪钳  
Import electric shear



T.SP.OMU16



T.SP.OMU22



T.SP.OTP50

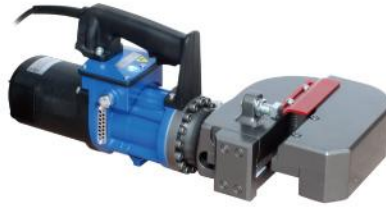

T.SP.OTP70



T.SP.TP110

代码 Model	T.SP.OMU16	T.SP.OMU22	T.SP.OTP50	T.SP.OTP70	T.SP.TP110
切割最大 Cut max	Φ16mm	Φ22mm R=70kg/mm <sup>2</sup>	50x17mm	70x15mm	110x10mm
电源 Power supply	230V/50Hz 120V/60Hz(a richiesta)	230V/50Hz	230V/50Hz	230V/50Hz	230V/50Hz
瓦 Watt	1100W	1150W	1150W	1150W	1150W
转速 Rpm	10.000/min.	10.000/min.	14.000/min.	14.000/min.	14.000/min.
液压压力 Hydraulic Rower	14 ton	22 ton	30 ton	30 ton	30 ton
压力 Pressure	560 bar	700 bar	700 bar	700 bar	700 bar
尺寸 Dimensions	520x120x130mm	450x140x235mm	500x140x250mm	550x150x250mm	570x250x250mm
重量 Weight	9.1kg	13kg	22kg	27kg	40kg



卓弓  
Sam bow  
T.RC.ZG001



活动卓弓  
Adjustable sam bow  
T.RC.ZG002

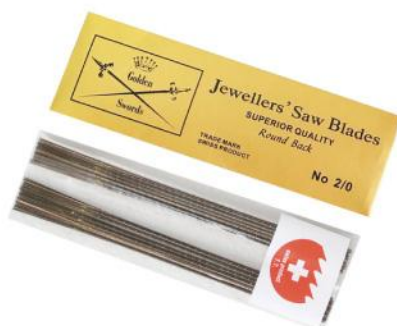

瑞士鱼牌锯条  
Switzerland GLARDON VALLORBE saw blades

双剑卓条  
Double ended file

德国双剑卓条  
Germany double ended file

代码 Model	规格 specification
T.SB.Z0001	2/0
T.SB.Z0002	3/0
T.SB.Z0003	4/0
T.SB.Z0004	5/0
T.SB.Z0005	6/0
T.SB.Z0006	7/0
T.SB.Z0007	8/0
T.SB.Z0008	0#
T.SB.Z0009	1#
T.SB.Z0010	2#
T.SB.Z0011	3#
T.SB.Z0012	4#
T.SB.Z0013	5#

代码 Model	规格 specification
T.SB.Z0016	2/0
T.SB.Z0017	3/0
T.SB.Z0018	4/0
T.SB.Z0019	5/0
T.SB.Z0020	6/0
T.SB.Z0021	7/0
T.SB.Z0022	8/0
T.SB.Z0023	0#
T.SB.Z0024	1#
T.SB.Z0025	2#
T.SB.Z0026	3#
T.SB.Z0027	4#
T.SB.Z0028	5#
T.SB.Z0029	6#
T.SB.Z0030	8#

代码 Model	规格 specification
T.SB.Z0031	0#
T.SB.Z0032	1#
T.SB.Z0033	2#
T.SB.Z0034	3#
T.SB.Z0035	4#
T.SB.Z0036	5#
T.SB.Z0037	6#
T.SB.Z0038	8#
T.SB.Z0039	2/0
T.SB.Z0040	3/0
T.SB.Z0041	4/0
T.SB.Z0042	5/0
T.SB.Z0043	6/0
T.SB.Z0044	7/0
T.SB.Z0045	8/0

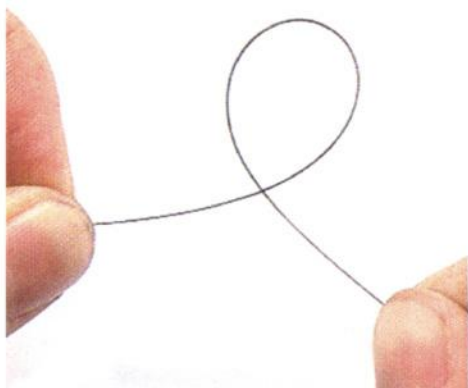

- 卓条齿非常均衡，不会有断断续续的齿。
- 卓条非常有弹性不易断，可以任意方向折。
- Saw blades are made evenly on double-end saw.
- It saw have good flexibility, you can fold it without break.

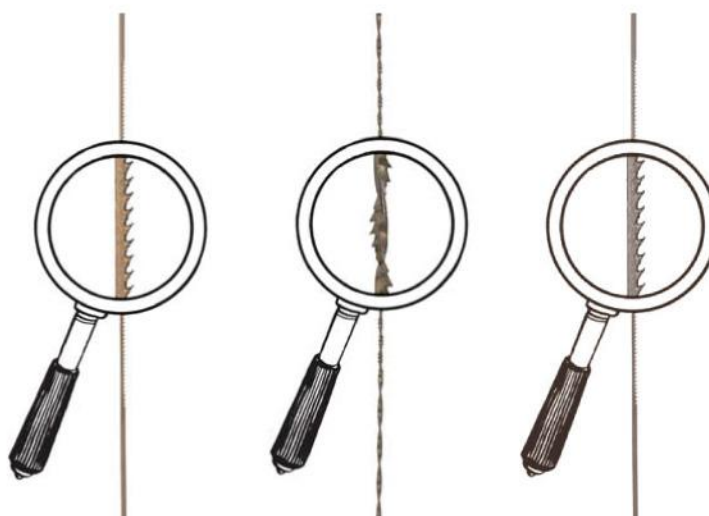

▲ 锯条 Saw blades

扁锉  
Flat file

代码 Model	名称 Designation	尺寸 Size	包装 Package
T.SB.Y0006-F-4	粗齿扁锉 Flat bastard file	4"	10Pcs/Box
T.SB.Y0006-F-6	粗齿扁锉 Flat bastard file	6"	10Pcs/Box
T.SB.Y0006-F-8	粗齿扁锉 Flat bastard file	8"	10Pcs/Box
T.SB.Y0006-F-10	粗齿扁锉 Flat bastard file	10"	10Pcs/Box
T.SB.Y0006-F-12	粗齿扁锉 Flat bastard file	12"	5Pcs/Box
T.SB.Y0006-F-14	粗齿扁锉 Flat bastard file	14"	5Pcs/Box
T.SB.Y0006-M-4	中齿扁锉 Medium toothed flat file	4"	10Pcs/Box
T.SB.Y0006-M-6	中齿扁锉 Medium toothed flat file	6"	10Pcs/Box
T.SB.Y0006-M-8	中齿扁锉 Medium toothed flat file	8"	10Pcs/Box
T.SB.Y0006-M-10	中齿扁锉 Medium toothed flat file	10"	10Pcs/Box
T.SB.Y0006-M-12	中齿扁锉 Medium toothed flat file	12"	5Pcs/Box
T.SB.Y0006-M-14	中齿扁锉 Medium toothed flat file	14"	5Pcs/Box
T.SB.Y0006-S-6	细齿扁锉 Fine toothed flat file	6"	10Pcs/Box
T.SB.Y0006-S-8	细齿扁锉 Fine toothed flat file	8"	10Pcs/Box
T.SB.Y0006-S-10	细齿扁锉 Fine toothed flat file	10"	10Pcs/Box
T.SB.Y0006-S-12	细齿扁锉 Fine toothed flat file	12"	5Pcs/Box



半圆锉  
Half circle file

代码 Model	名称 Designation	尺寸 Size	包装 Package
T.SB.Y0005-F-6	粗齿半圆锉 Coarse toothed semi-circular file	6"	10Pcs/Box
T.SB.Y0005-F-8	粗齿半圆锉 Coarse toothed semi-circular file	8"	10Pcs/Box
T.SB.Y0005-F-10	粗齿半圆锉 Coarse toothed semi-circular file	10"	10Pcs/Box
T.SB.Y0005-F-12	粗齿半圆锉 Coarse toothed semi-circular file	12"	5Pcs/Box
T.SB.Y0005-F-14	粗齿半圆锉 Coarse toothed semi-circular file	14"	5Pcs/Box
T.SB.Y0005-M-4	中齿半圆锉 Mid toothed semi-circular file	4"	10Pcs/Box
T.SB.Y0005-M-6	中齿半圆锉 Mid toothed semi-circular file	6"	10Pcs/Box
T.SB.Y0005-M-8	中齿半圆锉 Mid toothed semi-circular file	8"	10Pcs/Box
T.SB.Y0005-M-10	中齿半圆锉 Mid toothed semi-circular file	10"	10Pcs/Box
T.SB.Y0005-M-12	中齿半圆锉 Mid toothed semi-circular file	12"	5Pcs/Box
T.SB.Y0005-M-14	中齿半圆锉 Mid toothed semi-circular file	14"	5Pcs/Box
T.SB.Y0005-S-6	细齿半圆锉 Fine toothed semi-circular file	6"	10Pcs/Box
T.SB.Y0005-S-8	细齿半圆锉 Fine toothed semi-circular file	8"	10Pcs/Box
T.SB.Y0005-S-10	细齿半圆锉 Fine toothed semi-circular file	10"	10Pcs/Box
T.SB.Y0005-S-12	细齿半圆锉 Fine toothed semi-circular file	12"	5Pcs/Box



方锉  
Square file

代码 Model	名称 Designation	尺寸 Size	包装 Package
T.SB.Y0001-F-6	粗齿方锉 Coarse toothed square file	6"	10Pcs/Box
T.SB.Y0001-F-8	粗齿方锉 Coarse toothed square file	8"	10Pcs/Box
T.SB.Y0001-F-10	粗齿方锉 Coarse toothed square file	10"	10Pcs/Box
T.SB.Y0001-F-12	粗齿方锉 Coarse toothed square file	12"	5Pcs/Box
T.SB.Y0001-M-6	中齿方锉 Medium toothed square file	6"	10Pcs/Box
T.SB.Y0001-M-8	中齿方锉 Medium toothed square file	8"	10Pcs/Box
T.SB.Y0001-M-10	中齿方锉 Medium toothed square file	10"	10Pcs/Box
T.SB.Y0001-M-12	中齿方锉 Medium toothed square file	12"	5Pcs/Box



### 三角锉 Triangle file

代码 Model	名称 Designation	尺寸 Size	包装 Package
T.SB.Y0004-F-6	粗齿三角锉 Rough toothed triangular file	6"	10Pcs/Box
T.SB.Y0004-F-8	粗齿三角锉 Rough toothed triangular file	8"	10Pcs/Box
T.SB.Y0004-F-10	粗齿三角锉 Rough toothed triangular file	10"	10Pcs/Box
T.SB.Y0004-F-12	粗齿三角锉 Rough toothed triangular file	12"	5Pcs/Box
T.SB.Y0004-M-4	中齿三角锉 Medium toothed triangular file	4"	10Pcs/Box
T.SB.Y0004-M-5	中齿三角锉 Medium toothed triangular file	5"	10Pcs/Box
T.SB.Y0004-M-6	中齿三角锉 Medium toothed triangular file	6"	10Pcs/Box
T.SB.Y0004-M-8	中齿三角锉 Medium toothed triangular file	8"	10Pcs/Box
T.SB.Y0004-M-10	中齿三角锉 Medium toothed triangular file	10"	10Pcs/Box
T.SB.Y0004-M-12	中齿三角锉 Medium toothed triangular file	12"	5Pcs/Box

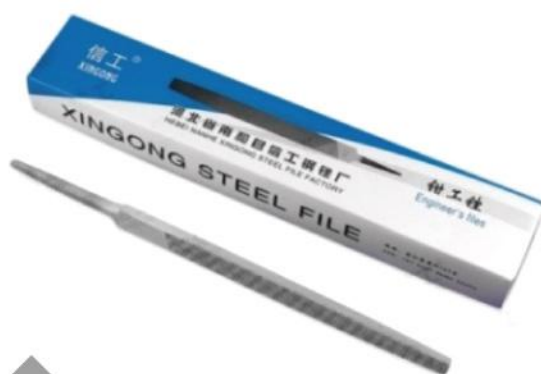

### 圆锉 Round file

代码 Model	名称 Designation	尺寸 Size	包装 Package
T.SB.Y0003-F-6	粗齿圆锉 Coarse toothed round file	6"	10Pcs/Box
T.SB.Y0003-F-8	粗齿圆锉 Coarse toothed round file	8"	10Pcs/Box
T.SB.Y0003-F-10	粗齿圆锉 Coarse toothed round file	10"	10Pcs/Box
T.SB.Y0003-F-12	粗齿圆锉 Coarse toothed round file	12"	5Pcs/Box
T.SB.Y0003-M-4	中齿圆锉 Medium toothed round file	4"	10Pcs/Box
T.SB.Y0003-M-6	中齿圆锉 Medium toothed round file	6"	10Pcs/Box
T.SB.Y0003-M-8	中齿圆锉 Medium toothed round file	8"	10Pcs/Box
T.SB.Y0003-M-10	中齿圆锉 Medium toothed round file	10"	10Pcs/Box
T.SB.Y0003-M-12	中齿圆锉 Medium toothed round file	12"	5Pcs/Box
T.SB.Y0003-M-14	中齿圆锉 Medium toothed round file	14"	5Pcs/Box



### 带柄扁锉 Flat file with handle

代码 Model	规格 Specifications	尺寸 Size
T.SB.Y0007-6	粗齿 Coarse toothed / 中齿 Medium toothed	6"
T.SB.Y0007-8	粗齿 Coarse toothed / 中齿 Medium toothed	8"
T.SB.Y0007-10	粗齿 Coarse toothed / 中齿 Medium toothed	10"
T.SB.Y0007-12	粗齿 Coarse toothed / 中齿 Medium toothed	12"



### 带柄半圆锉 Half circle file with handle

代码 Model	规格 Specifications	尺寸 Size
T.SB.Y0008-6	粗齿 Coarse toothed / 中齿 Medium toothed	6"
T.SB.Y0008-8	粗齿 Coarse toothed / 中齿 Medium toothed	8"
T.SB.Y0008-10	粗齿 Coarse toothed / 中齿 Medium toothed	10"
T.SB.Y0008-12	粗齿 Coarse toothed / 中齿 Medium toothed	12"



带柄三角锉  
Triangle file with handle

代码 Model	规格 Specifications	尺寸 Size
T.SB.Y0009-6	粗齿 Coarse toothed / 中齿 Medium toothed	6"
T.SB.Y0009-8	粗齿 Coarse toothed / 中齿 Medium toothed	8"
T.SB.Y0009-10	粗齿 Coarse toothed / 中齿 Medium toothed	10"
T.SB.Y0009-12	粗齿 Coarse toothed / 中齿 Medium toothed	12"



带柄圆锉  
Round file with handle

代码 Model	规格 Specifications	尺寸 Size
T.SB.Y0010-6	粗齿 Coarse toothed / 中齿 Medium toothed	6"
T.SB.Y0010-8	粗齿 Coarse toothed / 中齿 Medium toothed	8"
T.SB.Y0010-10	粗齿 Coarse toothed / 中齿 Medium toothed	10"
T.SB.Y0010-12	粗齿 Coarse toothed / 中齿 Medium toothed	12"



带柄方锉  
Square file with handle

代码 Model	规格 Specifications	尺寸 Size
T.SB.Y0011-6	粗齿 Coarse toothed / 中齿 Medium toothed	6"
T.SB.Y0011-8	粗齿 Coarse toothed / 中齿 Medium toothed	8"
T.SB.Y0011-11	粗齿 Coarse toothed / 中齿 Medium toothed	10"
T.SB.Y0011-12	粗齿 Coarse toothed / 中齿 Medium toothed	12"



黑柄套装锉  
Black handle file set

T.SB.00169-16  
Φ3×L140mm



黑柄套装锉  
Black handle file set

T.SB.00169-17  
Φ4×L160mm



黑柄套装锉  
Black handle file set

T.SB.00169-18  
Φ5×L180mm

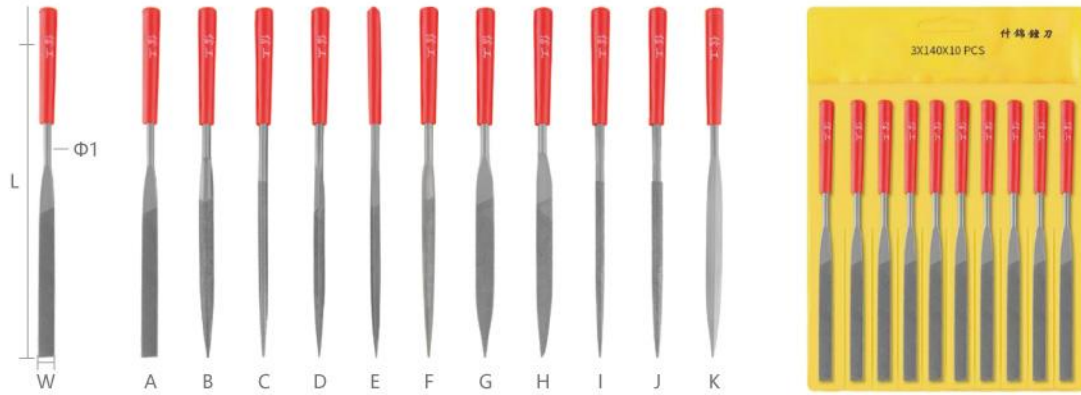

红柄套装锉(粗齿)  
Red handle set file (Coarse teeth)

代码 Model	名称 Designation	L	W	Φ1	厚度 Thickness	重量 Size	包装 Package
T.SB.00169-7	扁锉 Flat file	140mm	6.2mm	Φ3mm	1.42mm	102g	10 Pcs/Set
T.SB.00169-8	半圆锉 Half circle file	140mm	5.4mm	Φ3mm	1.9mm	97g	10 Pcs/Set
T.SB.00169-9	圆锉 Round file	140mm	3.1mm	Φ3mm	3.1mm	98g	10 Pcs/Set
T.SB.00169-10	三角锉 Triangle file	140mm	3.5mm	Φ3mm	3.4mm	97g	10 Pcs/Set
T.SB.00169-11	方锉 Square file	140mm	2.7mm	Φ3mm	2.7mm	88g	10 Pcs/Set
T.SB.00169-12	半圆锉 Half circle file	140mm	5mm	Φ3mm	2mm	-	10 Pcs/Set
T.SB.00169-13	尖扁锉 Flat pointed file	140mm	5.9mm	Φ3mm	1.4mm	-	10 Pcs/Set
T.SB.00169-14	刀锉 Knife file	140mm	5.2mm	Φ3mm	2.9mm	-	10 Pcs/Set
T.SB.00169-15	椭圆形锉 Elliptical file	140mm	3.3mm	Φ3mm	2.8mm	-	10 Pcs/Set
T.SB.00169-16	椭圆形锉 Elliptical file	140mm	5.1mm	Φ3mm	2.2	-	10 Pcs/Set
T.SB.00169-17	光三角锉 Optical triangular file	140mm	5.1mm	Φ3mm	2.2mm	-	10 Pcs/Set

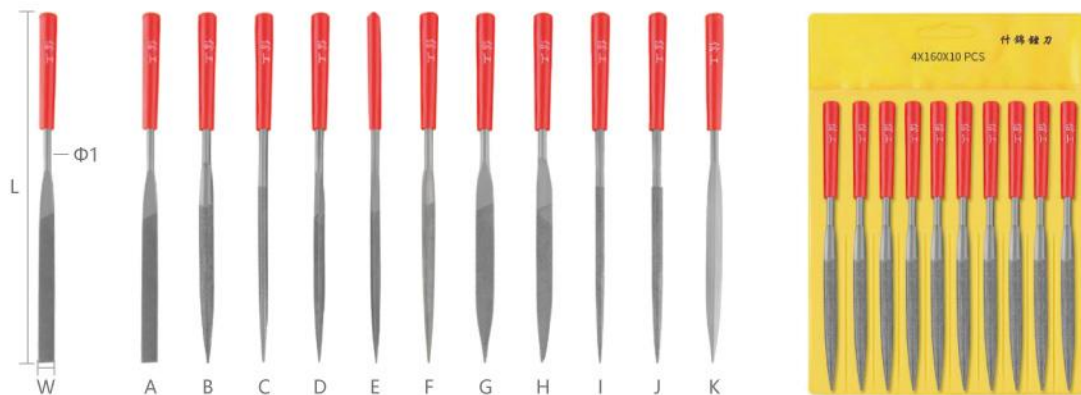

红柄套装锉(粗齿)  
Red handle set file (Coarse teeth)

代码 Model	名称 Designation	L	W	Φ1	厚度 Thickness	重量 Size	包装 Package
T.SB.00169-18	扁锉 Flat file	160mm	7.5mm	Φ4mm	2.2mm	180g	10 Pcs/Set
T.SB.00169-19	半圆锉 Half circle file	160mm	7.5mm	Φ4mm	2.2mm	180g	10 Pcs/Set
T.SB.00169-20	圆锉 Round file	160mm	3.9mm	Φ4mm	3.9mm	182g	10 Pcs/Set
T.SB.00169-21	三角锉 Triangle file	160mm	4.9mm	Φ4mm	4.8mm	181g	10 Pcs/Set
T.SB.00169-22	方锉 Square file	160mm	3.6mm	Φ4mm	3.6mm	167g	10 Pcs/Set
T.SB.00169-23	双半圆锉 Double semi-circular file	160mm	6.4mm	Φ4mm	2.9mm	-	10 Pcs/Set
T.SB.00169-24	尖扁锉 Flat pointed file	160mm	7.7mm	Φ4mm	1.9mm	-	10 Pcs/Set
T.SB.00169-25	刀锉 Knife file	160mm	7.2mm	Φ4mm	2.4mm	-	10 Pcs/Set
T.SB.00169-26	椭圆形锉 Elliptical file	160mm	4.3mm	Φ4mm	2.9mm	-	10 Pcs/Set
T.SB.00169-27	光三角锉 Optical triangular file	160mm	6.9mm	Φ4mm	2.9mm	-	10 Pcs/Set



红柄套装锉(粗齿)  
Red handle set file (Coarse teeth)

代码 Model	名称 Designation	L	W	Φ1	厚度 Thickness	重量 Size	包装 Package
T.SB.00169-28	扁锉 Flat file	180mm	9.8mm	Φ5mm	2.3mm	319g	10 Pcs/Set
T.SB.00169-29	半圆锉 Half circle file	180mm	8.6mm	Φ5mm	3.3mm	292g	10 Pcs/Set
T.SB.00169-30	圆锉 Round file	180mm	5.1mm	Φ5mm	5.1mm	292g	10 Pcs/Set
T.SB.00169-31	三角锉 Triangle file	180mm	6.3mm	Φ5mm	6.2mm	292g	10 Pcs/Set
T.SB.00169-32	方锉 Square file	180mm	4.6mm	Φ5mm	4.6mm	278g	10 Pcs/Set
T.SB.00169-33	双半圆锉 Double semi-circular file	180mm	7.9mm	Φ5mm	3.4mm	-	10 Pcs/Set
T.SB.00169-34	尖扁锉 Flat pointed file	180mm	10mm	Φ5mm	2.3mm	-	10 Pcs/Set
T.SB.00169-35	刀锉 Knife file	180mm	8.6mm	Φ5mm	3.3mm	-	10 Pcs/Set
T.SB.00169-36	椭圆形锉 Elliptical file	180mm	5.6mm	Φ5mm	4.9mm	-	10 Pcs/Set
T.SB.00169-37	光三角锉 Optical triangular file	180mm	8.6mm	Φ5mm	3.3mm	-	10 Pcs/Set



红柄套装锉(小柄)  
Red handle set file (Small handle)

代码 Model	尺寸 Size	重量 Weight
T.SB.00169	3×140×10mm	86g
T.SB.00169-2	4×160×10mm	146g
T.SB.00169-3	5×180×10mm	242g



红柄套装锉(大柄)  
Red handle set file (Large handle)

代码 Model	尺寸 Size	重量 Weight
T.SB.00169	3×140×10mm	86g
T.SB.00169-2	4×160×10mm	146g
T.SB.00169-3	5×180×10mm	242g

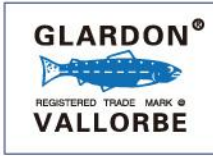

瑞士鱼牌锯  
Switzerland GLARDON VALLOBE file

(注: 瑞士原装进口鱼牌锯规格齐全,  
无法一一展示, 详情欢迎来电咨询! )  
(Note: Switzerland GLARDON VALLOBE  
saw blades are of full specifications.  
Welcome to contact for more details!)



**LA2401** Pilier / Pillar / Flachstumpf / Plana

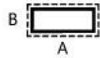

	00	0	1	2	3	4	6	L = mm	A x B = mm
		LA2401-100-0	LA2401-100-1	LA2401-100-2	LA2401-100-3	LA2401-100-4		100	3.5x0.9
	LA2401-140-00	LA2401-140-0	LA2401-140-1	LA2401-140-2	LA2401-140-3	LA2401-140-4	LA2401-140-6	140	4.8x1.1
	LA2401-160-00	LA2401-160-0	LA2401-160-1	LA2401-160-2	LA2401-160-3	LA2401-160-4	LA2401-160-6	160	5.4x1.2
	LA2401-180-00	LA2401-180-0	LA2401-180-1	LA2401-180-2	LA2401-180-3	LA2401-180-4	LA2401-180-6	180	6.0x1.3
	LA2401-200-00	LA2401-200-0	LA2401-200-1	LA2401-200-2	LA2401-200-3	LA2401-200-4		200	6.5x1.3

**LA2402** Mironde / Halfround / Halbrund / Mediacaña



	00	0	1	2	3	4	6	L = mm	A x B = mm
		LA2402-100-0	LA2402-100-1	LA2402-100-2	LA2402-100-3	LA2402-100-4		100	3.8x1.1
	LA2402-140-00	LA2402-140-0	LA2402-140-1	LA2402-140-2	LA2402-140-3	LA2402-140-4	LA2402-140-6	140	5.1x1.5
	LA2402-160-00	LA2402-160-0	LA2402-160-1	LA2402-160-2	LA2402-160-3	LA2402-160-4	LA2402-160-6	160	5.6x1.7
	LA2402-180-00	LA2402-180-0	LA2402-180-1	LA2402-180-2	LA2402-180-3	LA2402-180-4		180	5.9x2.0
	LA2402-200-00	LA2402-200-0	LA2402-200-1	LA2402-200-2	LA2402-200-3	LA2402-200-4		200	6.3x2.0

**LA2403** Feuille de sauge / Crossing / Vogelzunge / Almendra



	00	0	1	2	3	4	6	L = mm	A x B = mm
		LA2403-100-0		LA2403-100-2	LA2403-100-3	LA2403-100-4		100	3.5x1.4
	LA2403-140-00	LA2403-140-0	LA2403-140-1	LA2403-140-2	LA2403-140-3	LA2403-140-4		140	4.4x1.8
	LA2403-160-00	LA2403-160-0	LA2403-160-1	LA2403-160-2	LA2403-160-3	LA2403-160-4	LA2403-160-6	160	5.1x2.0
	LA2403-180-00	LA2403-180-0	LA2403-180-1	LA2403-180-2	LA2403-180-3	LA2403-180-4		180	5.8x2.2
	LA2403-200-00	LA2403-200-0	LA2403-200-1	LA2403-200-2	LA2403-200-3	LA2403-200-4		200	6.0x2.4

**LA2405** Couteau / Knife / Messer / Cuchillo



	00	0	1	2	3	4	6	L = mm	A x B = mm
		LA2405-100-0	LA2403-100-1	LA2405-100-2	LA2405-100-3	LA2405-100-4		100	4.0x1.1
	LA2405-140-00	LA2405-140-0	LA2405-140-1	LA2405-140-2	LA2405-140-3	LA2405-140-4	LA2405-140-6	140	5.0x1.4
	LA2405-160-00	LA2405-160-0	LA2405-160-1	LA2405-160-2	LA2405-160-3	LA2405-160-4	LA2405-160-6	160	5.4x1.5
	LA2405-180-00	LA2405-180-0	LA2405-180-1	LA2405-180-2	LA2405-180-3	LA2405-180-4		180	6.0x1.7
	LA2405-200-00	LA2405-200-0	LA2405-200-1	LA2405-200-2	LA2405-200-3	LA2405-200-4		200	6.4x1.8

**LA2406** Couteau / Knife / Messer / Cuchillo

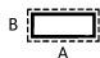

	00	0	1	2	3	4	6	L = mm	A x B = mm
		LA2406-100-0		LA2406-100-2	LA2406-100-3	LA2406-100-4		100	3.4x0.9
		LA2406-140-0	LA2406-140-1	LA2406-140-2	LA2406-140-3	LA2406-140-4		140	4.8x1.1
	LA2406-160-00	LA2406-160-0	LA2406-160-1	LA2406-160-2	LA2406-160-3	LA2406-160-4	LA2406-160-6	160	5.4x1.2
	LA2406-180-00	LA2406-180-0	LA2406-180-1	LA2406-180-2	LA2406-180-3	LA2406-180-4		180	6.0x1.2
		LA2406-200-0	LA2406-200-1	LA2406-200-2	LA2406-200-3	LA2406-200-4		200	6.5x1.4

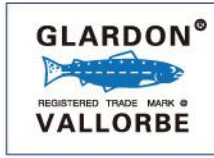

瑞士鱼牌锉  
Switzerland GLARDON VALLORBE file

(注: 瑞士原装进口鱼牌锉规格齐全,  
无法一一展示, 详情欢迎来电咨询! )  
(Note: Switzerland GLARDON BALLORBE  
saw blades are of full specifications.  
Welcome to contact for more details!)



**LA2407** Triang ire / Three-square / Dreikant / Triangular



00	0	1	2	3	4	6
	LA2407-100-0	LA2407-100-1	LA2407-100-2	LA2407-100-3	LA2407-100-4	
LA2407-140-00	LA2407-140-0	LA2407-140-1	LA2407-140-2	LA2407-140-3	LA2407-140-4	LA2407-140-6
LA2407-160-00	LA2407-160-0	LA2407-160-1	LA2407-160-2	LA2407-160-3	LA2407-160-4	LA2407-160-6
LA2407-180-00	LA2407-180-0	LA2407-180-1	LA2407-180-2	LA2407-180-3	LA2407-180-4	
LA2407-200-00	LA2407-200-0	LA2407-200-1	LA2407-200-2	LA2407-200-3	LA2407-200-4	

L = mm	A = mm
100	2.8
140	3.5
160	3.8
180	4.2
200	4.4

**LA2408** Carrée / Square / Vierkant / Cuadrada



00	0	1	2	3	4	6
	LA2408-100-0	LA2408-100-1	LA2408-100-2	LA2408-100-3	LA2408-100-4	
LA2408-140-00	LA2408-140-0	LA2408-140-1	LA2408-140-2	LA2408-140-3	LA2408-140-4	
LA2408-160-00	LA2408-160-0	LA2408-160-1	LA2408-160-2	LA2408-160-3	LA2408-160-4	LA2408-160-6
LA2408-180-00	LA2408-180-0	LA2408-180-1	LA2408-180-2	LA2408-180-3	LA2408-180-4	
LA2408-200-00	LA2408-200-0	LA2408-200-1	LA2408-200-2	LA2408-200-3	LA2408-200-4	

L = mm	A = mm
100	1.7
140	2.2
160	2.4
180	2.6
200	2.8

**LA2409** Ovale / Oval / Oval / Oval



00	0	1	2	3	4	6
		LA2409-140-1				
	LA2409-160-0	LA2409-160-1	LA2409-160-2	LA2409-160-3	LA2409-160-4	

L = mm	A x B = mm
140	3.5x2.4
160	3.9x2.5

**LA2410** Ronde / Round / Rund / Redonda



00	0	1	2	3	4	6
	LA2410-100-0	LA2410-100-1	LA2410-100-2	LA2410-100-3	LA2410-100-4	
LA2410-140-00	LA2410-140-0	LA2410-140-1	LA2410-140-2	LA2410-140-3	LA2410-140-4	LA2410-140-6
LA2410-160-00	LA2410-160-0	LA2410-160-1	LA2410-160-2	LA2410-160-3	LA2410-160-4	LA2410-160-6
LA2410-180-00	LA2410-180-0	LA2410-180-1	LA2410-180-2	LA2410-180-3	LA2410-180-4	
LA2410-200-00	LA2410-200-0	LA2410-200-1	LA2410-200-2	LA2410-200-3	LA2410-200-4	

L = mm	A = mm
100	2.1
140	2.8
160	2.9
180	3.2
200	3.5

**LA2411** Barrette / Barrette / Baret / Barrete



00	0	1	2	3	4	6
	LA2411-100-0		LA2411-100-2	LA2411-100-3	LA2411-100-4	
LA2411-140-00	LA2411-140-0	LA2411-140-1	LA2411-140-2	LA2411-140-3	LA2411-140-4	LA2411-140-6
LA2411-160-00	LA2411-160-0	LA2411-160-1	LA2411-160-2	LA2411-160-3	LA2411-160-4	LA2411-160-6
LA2411-180-00	LA2411-180-0	LA2411-180-1	LA2411-180-2	LA2411-180-3	LA2411-180-4	
LA2411-200-11	LA2411-200-0	LA2411-200-1	LA2411-200-2	LA2411-200-3	LA2411-200-4	

L = mm	A x B = mm
100	3.7x1.4
140	4.7x1.7
160	5.1x1.8
180	5.4x2.0
200	5.8x2.2

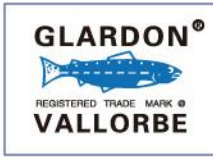

瑞士鱼牌锉  
Switzerland GLARDON VALLORBE file

(注: 瑞士原装进口鱼牌锉规格齐全,  
无法一一展示, 详情欢迎来电咨询! )  
(Note: Switzerland GLARDON BALLORBE  
saw blades are of full specifications.  
Welcome to contact for more details!)



**LA2415** Crochet / Crochet / Flachspitz mit runden Kanten / Gancho



00	0	1	2	3	4	6	L = mm	A x B = mm
	LA2415-140-0	LA2415-140-1	LA2415-140-2		LA2415-140-4		140	4.8x1.2
	LA2415-160-0	LA2415-160-1	LA2415-160-2	LA2415-160-3	LA2415-160-4	LA2415-160-6	160	5.4x1.3

**LA2416** Pilier bords ronds / Pillar round edges / Flachstumpf mit runden Kanten /



00	0	1	2	3	4	6	L = mm	A x B = mm
	LA2416-140-0	LA2416-140-1	LA2416-140-2		LA2416-140-4		140	4.8x1.2
	LA2416-160-00	LA2416-160-0	LA2416-160-1	LA2416-160-2	LA2416-160-3	LA2416-160-4	160	5.4x1.3

**LA2417** Coulisse bords ronds / Joint file round edges / Scharnierfeile mit runden Kanten /



00	0	1	2	3	4	6	L = mm	A x B = mm
				LA2417-100-3	LA2417-100-4		100	3.8x1.0

**LA2418** Mirondes, dos seul taillé/Halfround, cut on back only/Halbrund nur Rücken gehauen/



00	0	1	2	3	4	6	L = mm	A x B = mm
				LA2418-100-3	LA2418-100-4		100	3.8x1.2

**LA2420** Lime pour contact / Contact point file / Kontaktfeile / Lima para platinos



00	0	1	2	3	4	6	L = mm	A x B = mm
	LA2420-130-0		LA2420-130-2				130	8.0x0.9

**LA2423** Ronde très effilée / Round extra slim / Rund sehr dünn / Redonda muy aguda



00	0	1	2	3	4	6	L = mm	A = mm
		LA2423-100-1	LA2423-100-2	LA2423-100-3			100	1

**LA2427** Triangulaire angles vifs / Three-square sharped edges / Dreikant scharfe Kanten /



00	0	1	2	3	4	6	L = mm	A = mm
					LA2427-200-4		200	4.5

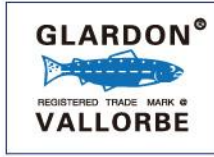

瑞士鱼牌锉  
Switzerland GLARDON VALLOBE file

(注: 瑞士原装进口鱼牌锉规格齐全,  
无法一一展示, 详情欢迎来电咨询! )  
(Note: Switzerland GLARDON VALLOBE  
saw blades are of full specifications.  
Welcome to contact for more details!)



LE3001	Aux verges / Dovetail / Für Spindeln / Para husillos									L = mm	A x B = mm
	0	2	3	4	5	6	8	10		35	3x1
	LE3001-35-2		LE3001-35-4			LE3001-35-6					
LE3004	Couteau pointu / Knife pointed / Messer spitz / Cuchillo punta									L = mm	A x B = mm
	0	2	3	4	5	6	8	10		55	5x1.3
	LE3004-55-0	LE3004-55-2		LE3004-55-4	LE3004-55-5	LE3004-55-6	LE3004-55-8	LE3004-55-10			
LE3007	Barrette 3 cotés taillés / Barrette 3 sides cut / Barrett 3 Seiten gehauen /									L = mm	A x B = mm
	0	2	3	4	5	6	8	10		55	4.5x1.3
	LE3007-55-2		LE3007-55-4			LE3007-55-6					
LE3008	Mironde / Halfround / Halbrund / Mediacaña									L = mm	A x B = mm
	0	2	3	4	5	6	8	10		40	3.8x1.4
	LE3008-40-0	LE3008-40-2	LE3008-40-3	LE3008-40-4	LE3008-40-5	LE3008-40-6	LE3008-40-8	LE3008-40-10			
	LE3008-55-0	LE3008-55-2	LE3008-55-3	LE3008-55-4	LE3008-55-5	LE3008-55-6	LE3008-55-8	LE3008-55-10		55	4.6x1.6
LE3009	Feuille de sauge / Crossing / Vogelzunge / Almendra									L = mm	A x B = mm
	0	2	3	4	5	6	8	10		40	3.7x1.4
	LE3009-40-2		LE3009-40-4			LE3009-40-6		LE3009-40-8			
	LE3009-55-2		LE3009-55-4			LE3009-55-5		LE3009-55-6		LE3009-40-10	
LE3010	Barrette / Barrette / Barrett / Barrete									L = mm	A x B = mm
	0	2	3	4	5	6	8	10		40	3.7x1.3
	LE3010-40-0	LE3010-40-2	LE3010-40-3	LE3010-40-4		LE3010-40-6	LE3010-40-8				
	LE3010-55-0	LE3010-55-2	LE3010-55-3	LE3010-55-4	LE3010-55-5	LE3010-55-6	LE3010-55-8	LE3010-55-10		55	4.5x1.3
LE3011	Barrette parallèle / Barrette parallel / Barrett parallel / Barrete paralela									L = mm	A x B = mm
	0	2	3	4	5	6	8	10		48	4.1x1.2
	LE3011-48-2		LE3011-48-4			LE3011-48-6					

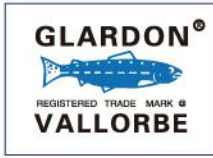

瑞士鱼牌锉  
Switzerland GLARDON VALLORBE file

(注: 瑞士原装进口鱼牌锉规格齐全,  
无法一一展示, 详情欢迎来电咨询! )  
(Note: Switzerland GLARDON BALLORBE  
saw blades are of full specifications.  
Welcome to contact for more details!)



**LE3014** Triangulaire / Three-square / Dreikant / Triangular



0	2	3	4	5	6	8	10	L = mm	A = mm
LE3014-40-2		LE3014-40-4		LE3014-40-6				40	2.8
LE3014-55-0	LE3014-55-2	LE3014-55-3	LE3014-55-4	LE3014-55-5	LE3014-55-6	LE3014-55-8	LE3014-55-10	55	3.4

**LE3015** Entrée de fourchette / Watch anchor / Ankergefelle / Para horquillas de ancora



0	2	3	4	5	6	8	10	L = mm	A x B = mm	
					LE3015-55-6		LE3015-55-8		55	4.4x0.8

**LE3016** Entrée / Warding / Flachspitz / Plana de punta



0	2	3	4	5	6	8	10	L = mm	A x B = mm
LE3016-55-0	LE3016-55-2	LE3016-55-4		LE3016-55-6				55	4.6x0.9



**LE3020** Carrée / Square / Vierkant / Cuadrada



0	2	3	4	5	6	8	10	L = mm	A = mm
LE3020-55-0	LE3020-55-2	LE3020-55-3	LE3020-55-4	LE3020-55-5	LE3020-55-6	LE3020-55-8	LE3020-55-10	55	1.7
LE3020-65-0	LE3020-65-2	LE3020-65-3	LE3020-65-4	LE3020-65-6		LE3020-65-8		65	1.9

**LE3021** Ronde / Round / Rund / Redonda



0	2	3	4	5	6	8	10	L = mm	A = mm
LE3021-55-0	LE3021-55-2	LE3021-55-3	LE3021-55-4	LE3021-55-5	LE3021-55-6	LE3021-55-8	LE3021-55-10	55	1.5
LE3021-65-0	LE3021-65-2	LE3021-65-3	LE3021-65-4	LE3021-65-5	LE3021-65-6	LE3021-65-8		65	2

**LE3026** Feuille de sauge à côtes / Balance wheel / Vogelzunge mit scharfem Rücken /



0	2	3	4	5	6	8	10	L = mm	A x B = mm
LE3026-35-2		LE3026-35-4		LE3026-35-6		LE3026-35-8		LE3026-35-10	
								35	2.9x1.2

**LE3029** Egalir / Equalling / Ausstreich / De igualar



0	2	3	4	5	6	8	10	L = mm	A x B = mm
LE3029-55-2-DT			LE3029-55-4-DT					55	4.7x0.7

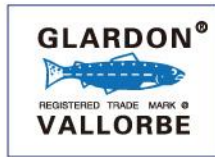

瑞士鱼牌锉  
Switzerland GLARDON VALLORBE file

(注: 瑞士原装进口鱼牌锉规格齐全,  
无法一一展示, 详情欢迎来电咨询! )  
(Note: Switzerland GLARDON BALLORBE  
saw blades are of full specifications.  
Welcome to contact for more details!)

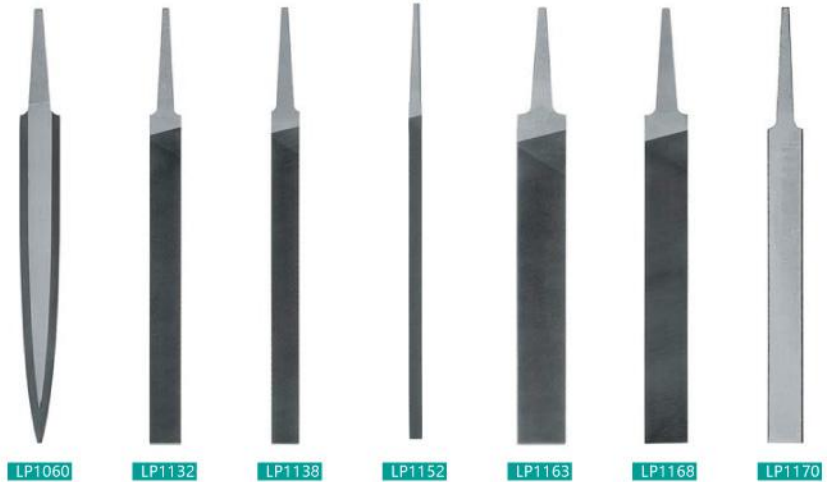

**LP1060** Barrette / Barrette / Baret / Barrete



00	0	1	2	3	4	5	6
LP1060-4-00	LP1060-4-0	LP1060-4-1	LP1060-4-2	LP1060-4-3	LP1060-4-4		
LP1060-6-00	LP1060-6-0	LP1060-6-1	LP1060-6-2	LP1060-6-3	LP1060-6-4		

L = "/mm	A x B = mm
4/100	12.4x2.6
6/150	15.5x3.5

**LP1132** Pilier ordinaire / Pillar / Stiften normal / Plana paralela normal



00	0	1	2	3	4	5	6
LP1132-6-00	LP1132-6-0	LP1132-6-1	LP1132-6-2	LP1132-6-3	LP1132-6-4		LP1132-6-6
	LP1132-8-0		LP1132-8-2		LP1132-8-4		

L = "/mm	A x B = mm
6/150	12x4
8/200	14.5x4.5

**LP1138** Pilier mince / Pillar thin / Stiften dünn / Plana paralela delgada



00	0	1	2	3	4	5	6
LP1138-6-00	LP1138-6-0	LP1138-6-1	LP1138-6-2		LP1138-6-4		

L = "/mm	A x B = mm
6/150	10.5x2.4

**LP1152** Pilier très étroit / Pillar extra slim / Stiften sehr Schmall / Plan paralela muy estrecha



00	0	1	2	3	4	5	6
LP1152-6-00	LP1152-6-0	LP1152-6-1	LP1152-6-2	LP1152-6-3	LP1152-6-4		LP1152-6-6

L = "/mm	A x B = mm
6/150	4.5x2.5

**LP1163** Carrelette / Hand / Ansatz - Flachstumpf / Carleta



000	00	0	1	2	3	4	5	6	
	LP1163-4-00	LP1163-4-0	LP1163-4-1	LP1163-4-2	LP1163-4-3	LP1163-4-4	LP1163-4-5	LP1163-4-6	
	LP1163-6-000	LP1163-6-00	LP1163-6-0	LP1163-6-1	LP1163-6-2	LP1163-6-3	LP1163-6-4	LP1163-6-5	LP1163-6-6
	LP1163-8-000	LP1163-8-00	LP1163-8-0	LP1163-8-1	LP1163-8-2	LP1163-8-3	LP1163-8-4	LP1163-8-6	
	LP1163-10-000	LP1163-10-00	LP1163-10-0	LP1163-10-1	LP1163-10-2	LP1163-10-3	LP1163-10-4		

L = "/mm	A x B = mm
4/100	12.5x3.0
6/150	18.5x4.0
8/200	21.3x4.8
10/250	25.3x6.3

**LP1168** Carrelette mince / Thin hand / Ansatz - Flachstumpf dünn / Carleta delgada



00	0	1	2	3	4	5	6
LP1168-6-00	LP1168-6-0	LP1168-6-1	LP1168-6-2		LP1168-6-4		

L = "/mm	A x B = mm
6/150	16.5x2

**LP1170** Triangulaire / Three-square / Dreikant / Triangular



0,3	0,4	0,5	0,6	1,3
LP1170-4-2-0,3	LP1170-4-2-0,4	LP1170-4-2-0,5	LP1170-4-2-0,6	LP1170-4-2-1,3

L = "/mm	A = mm
4/100	10

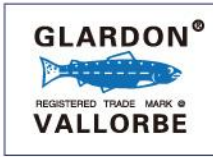

瑞士鱼牌锉  
Switzerland GLARDON VALLORBE file

(注: 瑞士原装进口鱼牌锉规格齐全,  
无法一一展示, 详情欢迎来电咨询!)  
(Note: Switzerland GLARDON VALLORBE  
saw blades are of full specifications.  
Welcome to contact for more details!)



**LP1360** Triangulaire / Three-square / Dreikant / Triangular



000	00	0	1	2	3	4	5	6	L = "/mm	A = mm
LP1360-6-000	LP1360-6-00	LP1360-6-0	LP1360-6-1	LP1360-6-2	LP1360-6-3	LP1360-6-4		LP1360-6-6	6/150	10.3
LP1360-8-000	LP1360-8-00	LP1360-8-0	LP1360-8-1	LP1360-8-2	LP1360-8-3	LP1360-8-4		LP1360-8-6	8/200	14.2

**LP1366** Triangulaire effilée / Three square narrow / Dreikant schmal / Triangular delgada



00	0	1	2	3	4	5	6	L = "/mm	A = mm
LP1366-6-00	LP1366-6-0	LP1366-6-1		LP1366-6-3				6/150	8.3

**LP1464** Carrée pointue / Square pointed / Vierkant spitz / Cuadrada aguda



00	0	1	2	3	4	5	6	L = "/mm	A = mm
		LP1464-6-1	LP1464-6-2	LP1464-6-3	LP1464-6-4			6/150	5.5

**LP1480** Carrée à étirer / Square seconds hole / Vierkantfeile f. Zapfenlöcher / Cuadrada para aguja segundero



00	0	1	2	3	4	5	6	L = "/mm	A = mm
			LP1480-2-2					2/50	1

**LP1540** Mironde double / Vul-Crylic file / Halbrund doppelt / Mediacaña doble



	L = mm	A x B = mm
LP1540-6	6/150	12.5x3.5
LP1540-7	7/175	12.5x3.5
LP1540-8	8/200	13.5x4.0

**LP1545** Mironde pour bijoutiers / Halfround for jewellers / Halbrunde Goldschmiede-Feile



00	0	1	2	3	4	5	6	L = "/mm	A x B = mm
	LP1545-4,5-0		LP1545-4,5-2					4.5/15	12.0x3.3

**LP1560** Mironde ordinaire / Halfround / Halbrund normal / Mediacaña normal



000	00	0	1	2	3	4	5	6	L = "/mm	A x B = mm
	LP1560-5-00	LP1560-5-0	LP1560-5-1	LP1560-5-2	LP1560-5-3	LP1560-5-4	LP1560-5-5	LP1560-5-6	5/125	13.1x4.1
LP1560-6-000	LP1560-6-00	LP1560-6-0	LP1560-6-1	LP1560-6-2	LP1560-6-3	LP1560-6-4	LP1560-6-5	LP1560-6-6	6/150	15.1x4.7
LP1560-8-000	LP1560-8-00	LP1560-8-0	LP1560-8-1	LP1560-8-2	LP1560-8-3	LP1560-8-4			8/200	21.1x6.3

**LP1566** Mironde effilée, pour bagues / Halfround slim or ring file / Halbrund schlank, für Ringe



000	00	0	1	2	3	4	5	6	L = "/mm	A x B = mm
	LP1566-6-00	LP1566-6-0	LP1566-6-1	LP1566-6-2	LP1566-6-3	LP1566-6-4		LP1566-6-6	6/150	12.7x3.5

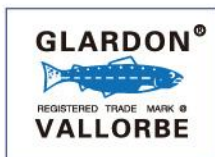

瑞士鱼牌锉  
Switzerland GLARDON VALLORBE file

(注: 瑞士原装进口鱼牌锉规格齐全,  
无法一一展示, 详情欢迎来电咨询! )  
(Note: Switzerland GLARDON BALLORBE  
saw blades are of full specifications.  
Welcome to contact for more details!)



File Type	00	0	1	2	3	4	5	6	L = "/mm	A x B = mm
<b>LP1567</b> Mironde très effilée / Halfround extra narrow / Halbrund sehr schlank / Mediacaña muy fina										
	LP1567-6-0		LP1567-6-2		LP1567-6-4				6/150	9.8x2.8
<b>LP1660</b> Ronde ordinaire pointue / Round pointed / Rund normal spitz / Redonda normal aguda									L = "/mm	A = mm
	LP1660-6-1		LP1660-6-2	LP1660-6-3	LP1660-6-4		LP1660-6-6		6/150	5.8
	LP1660-8-1		LP1660-8-2	LP1660-8-3	LP1660-8-4				8/200	7.8
<b>LP1680</b> Ronde à étirer / Round seconds hole / Rund f. Zapfenlöcher / Redonda para aguja segundero									L = "/mm	A = mm
	LP1680-1,5-2								1.5/38	1
					LP1680-2-4				2/50	1
<b>LP1840</b> A fendre à queue / Screwhead with tang / Einstreichfeile mit Angel / Lima de ranurar con espiga									L = "/mm	A x B = mm
	00 = 1	1 = 0.8		2 = 0.7		3 = 0.6		4 = 0.55	4/100	11x0.5
	LP1840-4-00	LP1840-4-0		LP1840-4-2		LP1840-4-3		LP1840-4-4		
<b>LP1850</b> A fendre sans queue / Screwhead without tang / Einstreichfeile ohne Angel /									L = "/mm	A x B = mm
	2 = 0.70		4 = 0.55		5 = 0.5		6 = 0.45		3/75	9x0.5
	LP1850-3-2		LP1850-3-4		LP1850-3-5		LP1850-3-6		LP1850-3-8	
<b>LP1960</b> Feuille de sauge / Crossing / Vogelzunge / Almendra									L = "/mm	A x B = mm
	LP1960-6-00	LP1960-6-0	LP1960-6-1	LP1960-6-2	LP1960-6-3	LP1960-6-4		6/150	14.8x5	
	LP1960-8-00	LP1960-8-0	LP1960-8-1	LP1960-8-2	LP1960-8-3	LP1960-8-4		8/200	21.3x6.3	
<b>LP1990</b> Ovale poinçons / Diesinker oval / Raumfeilen oval / Lima oval para punzones									L = "/mm	A x B = mm
	LP1990-6-2								6/150	8.6x4.4

锉  
Files

名称 Description	型号 Model
大板锉 Hand file	T.SB.00029
双头锉 Double ended wax file	T.SB.00030
红柄卜锉 (国产) Halfround file with red handle	T.SB.00046
三角锉 (国产) Triangle file with red handle	T.SB.00048
小三角锉 (国产) Small triangle file	T.SB.00049
金刚锉 Diamond file	T.SB.00050
平锉 (国产) Flat file	T.SB.00055
竹叶锉 (国产) Barrette file	T.SB.00056
方锉 (进口) Square file	T.SB.00057
8寸双头蜡锉 8" double-end wax files	ALP1540-8

铲刀  
Graver

名称 Description	型号 Model
6#鱼牌铲刀401-6 6# GLARDON VALLORBE graver 401-6	T.SB.00014
8#鱼牌铲刀401-8 8# GLARDON VALLORBE graver 401-8	T.SB.00015
10#鱼牌铲刀401-10 10# GLARDON VALLORBE graver 401-10	T.SB.00016
0#鱼牌三角铲刀403-0 0# GLARDON VALLORBE graver 403-0	T.SB.00017
1#鱼牌三角铲刀403-1 1# GLARDON VALLORBE graver 403-1	T.SB.00018
2#鱼牌三角铲刀403-2 2# GLARDON VALLORBE graver 403-2	T.SB.00019
3#鱼牌三角铲刀403-3 3# GLARDON VALLORBE graver 403-3	T.SB.00020
4#鱼牌三角铲刀403-4 4# GLARDON VALLORBE graver 403-3	T.SB.00021
5#鱼牌三角铲刀403-5 5# GLARDON VALLORBE graver 403-5	T.SB.00022



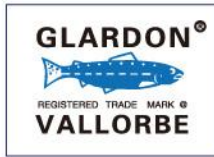

瑞士鱼牌锉

Switzerland GLARDON VALLOBE file

(注: 瑞士原装进口鱼牌锉规格齐全, 无法一一展示, 详情欢迎来电咨询! )  
(Note: Switzerland GLARDON VALLOBE saw blades are of full specifications. Welcome to contact for more details!)



LO0401



LO0402



LO0403

**LO0401** Bord plat / Flat edge / Flach / Borde plano



HSS L = 65 mm		WS L = 80 mm		N°	A = mm
LO0401-2-HSS		LO0401-2-WS		2	0.2
LO0401-4-HSS		LO0401-4-WS		4	0.4
LO0401-6-HSS		LO0401-6-WS		6	0.6
LO0401-8-HSS		LO0401-8-WS		8	
LO0401-10-HSS		LO0401-10-WS		10	
LO0401-12-HSS		LO0401-12-WS		12	
LO0401-14-HSS		LO0401-14-WS		14	
LO0401-16-HSS		LO0401-16-WS		16	
LO0401-18-HSS				18	
LO0401-20-HSS				20	
LO0401-24-HSS				24	

**LO0402** Bord rond / Round edge / Boll / Borde redondo



HSS L = 65 mm		WS L = 80 mm		N°	A = mm
LO0402-2-HSS		LO0402-2-WS		2	0.2
LO0402-4-HSS		LO0402-4-WS		4	0.4
LO0402-6-HSS		LO0402-6-WS		6	0.6
LO0402-8-HSS		LO0402-8-WS		8	0.8
LO0402-10-HSS		LO0402-10-WS		10	1.0
LO0402-12-HSS		LO0402-12-WS		12	1.2
LO0402-14-HSS		LO0402-14-WS		14	1.4
LO0402-16-HSS		LO0402-16-WS		16	1.6
LO0402-18-HSS		LO0402-18-WS		18	1.8
LO0402-20-HSS		LO0402-20-WS		20	2.0
		LO0402-24-WS		24	2.4

**LO0403** Onglette / Onglette / Spitz / De punta



HSS L = 65 mm		WS L = 80 mm		N°	A = mm
LO0403-5/0-HSS		LO0403-5/0-WS		5/0	1.16
LO0403-4/0-HSS		LO0403-4/0-WS		4/0	1.24
LO0403-3/0-HSS		LO0403-3/0-WS		3/0	1.35
LO0403-2/0-HSS		LO0403-2/0-WS		2/0	1.45
LO0403-0-HSS		LO0403-0-WS		0	1.58
LO0403-1-HSS		LO0403-1-WS		1	1.78
LO0403-2-HSS		LO0403-2-WS		2	1.94
LO0403-3-HSS		LO0403-3-WS		3	2.16
LO0403-4-HSS		LO0403-4-WS		4	2.54
LO0403-5-HSS		LO0403-5-WS		5	2.74
LO0403-6-HSS		LO0403-6-WS		6	2.94
LO0403-7-HSS		LO0403-7-WS		7	3.14
LO0403-8-HSS		LO0403-8-WS		8	3.36

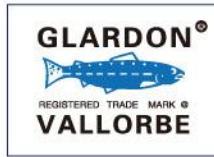

瑞士鱼牌锯  
Switzerland GLARDON VALLORBE file

(注: 瑞士原装进口鱼牌锯规格齐全,  
无法一一展示, 详情欢迎来电咨询! )  
(Note: Switzerland GLARDON BALLORBE  
saw blades are of full specifications.  
Welcome to contact for more details!)



**LO0404**    Ovale / Oval / Oval / Oval



WS L = 80 mm

LO0404-15
LO0404-17
LO0404-19
LO0404-21
LO0404-23
LO0404-25

N°	A = mm
15	1.5
17	1.7
19	1.9
21	2.1
23	2.3
25	2.5

**LO0405**    A biseau / Bevel / Facetten / Chaflán



WS L = 80 mm

LO0405-2
LO0405-4
LO0405-6
LO0405-8
LO0405-10
LO0405-12
LO0405-14
LO0405-16
LO0405-18
LO0405-20

N°	A = mm
2	0.2
4	0.4
6	0.6
8	0.8
10	1.0
12	1.2
14	1.4
16	1.6
18	1.8
20	2.0

**LO0406**    Tranchante / Knife / Messer / Cuchillo



HSS L = 65 mm

WS L = 80 mm

LO0406-18-HSS	LO0406-18-WS
LO0406-20-HSS	LO0406-20-WS
LO0406-22-HSS	LO0406-22-WS
LO0406-24-HSS	LO0406-24-WS
LO0406-26-HSS	LO0406-26-WS
LO0406-28-HSS	LO0406-28-WS
LO0406-30-HSS	LO0406-30-WS
LO0406-32-HSS	LO0406-32-WS

N°	A = mm
18	1.8
20	2.0
22	2.2
24	2.4
26	2.6
28	2.8
30	3.0
32	3.2

**LO0408**    A revider plate / Flat narrow back / Flach zum Ausrunden / Plano



WS L = 80 mm

LO0408-16
LO0408-18
LO0408-20
LO0408-22
LO0408-24
LO0408-26
LO0408-28

N°	A = mm
16	1.6
18	1.8
20	2.0
22	2.2
24	2.4
26	2.6
28	2.8

针钻系列 Burs and drills

规格说明 Specifications: 005 = 0.5mm, 010 = 1mm.....080 = 8mm



德国蓝盒针钻系列  
Germany KOMET burs series

F1波针 F1 round burs set

型号 Model	直径 Diameter (mm)
T.SL.KF0099-T.SL.KF0119	003-023
T.SL.KF0120-T.SL.KF0127	024-040
T.SL.KF0142-T.SL.KF0180	042-080

F3轮针 F3 wheel burs set

型号 Model	直径 Diameter (mm)
T.SL.KF0202-T.SL.KF0219	006-023

F5伞针 F5 pointed burs set

型号 Model	直径 Diameter (mm)
T.SL.KF0305-T.SL.KF0319	009-023
T.SL.KF0320-T.SL.KF0323	025-031

F6桃针 F6 bud burs set

型号 Model	直径 Diameter (mm)
T.SL.KF0405-T.SL.KF0419	009-023
T.SL.KF0420-T.SL.KF0423	025-031

F36直牙针 F36 cylinder burs set

型号 Model	直径 Diameter (mm)
T.SL.KF0502-T.SL.KF0519	006-023
T.SL.KF0520-T.SL.KF0522	025-027

F38斜牙针 F38 cone burs set

型号 Model	直径 Diameter (mm)
T.SL.KF0621-T.SL.KF0619	005-023
T.SL.KF0620	025

F203钻针 F203 twist drill

型号 Model	直径 Diameter (mm)
T.SL.KF0701-T.SL.KF0719	005-023

F249雕刻针 F249 carving burs set

型号 Model	直径 Diameter (mm)
T.SL.KF0805-T.SL.KF0819	009-023

F253厚飞碟 F253 bearing cutter

型号 Model	直径 Diameter (mm)
T.SL.KF0905-T.SL.KF0919	005-023
T.SL.KF0921-T.SL.KF0933	025-037

F253W薄飞碟 F253W bearing cutter

型号 Model	直径 Diameter (mm)
T.SL.KF1005-T.SL.KF1019	009-023
T.SL.KF1021	025

F256密口吸珠 F256 bearing cutter

型号 Model	直径 Diameter (mm)
T.SL.KF1105-T.SL.KF1119	009-023
T.SL.KF1120-T.SL.KF1125	024-029

F256A开口吸珠 F256A concave cutter

型号 Model	直径 Diameter (mm)
T.SL.KF1205-T.SL.KF1219	009-023



瑞士万利发针钻系列  
Switzerland maillefer burs series

23#波针 23# round burs set

型号 Model	直径 Diameter (mm)
T.SL.23005-T.SL.23023	005-023
T.SL.23024-T.SL.23040	024-040
T.SL.23045-T.SL.23065	045-065

25#轮针 25# wheel burs set

型号 Model	直径 Diameter (mm)
T.SL.25006-T.SL.25023	006-023

34#直牙针 34# cylinder burs set

型号 Model	直径 Diameter (mm)
T.SL.34007-T.SL.34023	007-023

38#斜牙针 38# cone burs set

型号 Model	直径 Diameter (mm)
T.SL.38006-T.SL.38023	006-023

58#钻针 58# twist drill

型号 Model	直径 Diameter (mm)
T.SL.38006-T.SL.38023	005-023

HB#薄飞碟 HB# bearing cutter

型号 Model	直径 Diameter (mm)
T.SL.HB009-T.SL.HB023	009-023

HD#厚飞碟 HD# bearing cutter

型号 Model	直径 Diameter (mm)
T.SL.HD008-T.SL.HD023	008-023
T.SL.HD024-T.SL.HD040	024-040
T.SL.HD042-T.SL.HD045	042-045

S密口吸珠 S bearing cutter

型号 Model	直径 Diameter (mm)
T.SL.S008-T.SL.S023	008-023
T.SL.S040	040

HH超薄飞碟 HH bearing cutter

型号 Model	直径 Diameter (mm)
T.SL.HH009-T.SL.HH023	009-023

钨钢牙针138 Tungsten carbide cross cut burs

型号 Model	直径 Diameter (mm)
T.SL.138012	012



德国DZ钨钢波针  
German DZ Round burs set

代码 Model	规格 specification	代码 Model	规格 specification	代码 Model	规格 specification
T.SL.WGDZ03	003	T.SL.WGDZ10	010	T.SL.WGDZ17	017
T.SL.WGDZ04	004	T.SL.WGDZ11	011	T.SL.WGDZ18	018
T.SL.WGDZ05	005	T.SL.WGDZ12	012	T.SL.WGDZ19	019
T.SL.WGDZ06	006	T.SL.WGDZ13	013	T.SL.WGDZ20	020
T.SL.WGDZ07	007	T.SL.WGDZ14	014	T.SL.WGDZ21	021
T.SL.WGDZ08	008	T.SL.WGDZ15	015	T.SL.WGDZ23	023
T.SL.WGDZ09	009	T.SL.WGDZ16	016	T.SL.WGDZ27	027



KS钨钢波针  
KS round burs set

代码 Model	规格 specification	代码 Model	规格 specification	代码 Model	规格 specification
T.SL.WGF10105	005	T.SL.WGF10112	012	T.SL.WGF10119	019
T.SL.WGF10106	006	T.SL.WGF10113	013	T.SL.WGF10120	020
T.SL.WGF10107	007	T.SL.WGF10114	014	T.SL.WGF10121	021
T.SL.WGF10108	008	T.SL.WGF10115	015	T.SL.WGF10122	022
T.SL.WGF10109	009	T.SL.WGF10116	016	T.SL.WGF10123	023
T.SL.WGF10110	010	T.SL.WGF10117	017		
T.SL.WGF10111	011	T.SL.WGF10118	018		



KS钨钢牙针  
KS cylinder burs set

代码 Model	规格 specification	代码 Model	规格 specification
T.SL.WGF13808	008	T.SL.WGF13816	016
T.SL.WGF13809	009	T.SL.WGF13817	017
T.SL.WGF13810	010	T.SL.WGF13818	018
T.SL.WGF13811	011	T.SL.WGF13819	019
T.SL.WGF13812	012	T.SL.WGF13820	020
T.SL.WGF13813	013	T.SL.WGF13821	021
T.SL.WGF13814	014	T.SL.WGF13822	022
T.SL.WGF13815	015	T.SL.WGF13823	023



白盒钨钢牙针  
White box cylinder burs set

代码 Model	规格 specification	代码 Model	规格 specification
T.SL.WGBH006	006	T.SL.WGBH015	015
T.SL.WGBH007-1	007	T.SL.WGBH016	016
T.SL.WGBH008	008	T.SL.WGBH017	017
T.SL.WGBH009	009	T.SL.WGBH018	018
T.SL.WGBH010	010	T.SL.WGBH019	019
T.SL.WGBH011	011	T.SL.WGBH020	020
T.SL.WGBH012	012	T.SL.WGBH021	021
T.SL.WGBH013	013	T.SL.WGBH022	022
T.SL.WGBH014	014	T.SL.WGBH023	023



白盒钨钢钻针  
White box twist drill

代码 Model	规格 specification	代码 Model	规格 specification
T.SL.WGBHZ005	005	T.SL.WGBHZ015	015
T.SL.WGBHZ006	006	T.SL.WGBHZ016	016
T.SL.WGBHZ007	007	T.SL.WGBHZ017	017
T.SL.WGBHZ008	008	T.SL.WGBHZ018	018
T.SL.WGBHZ009	009	T.SL.WGBHZ019	019
T.SL.WGBHZ010	010	T.SL.WGBHZ020	020
T.SL.WGBHZ011	011	T.SL.WGBHZ021	021
T.SL.WGBHZ012	012	T.SL.WGBHZ022	022
T.SL.WGBHZ013	013	T.SL.WGBHZ023	023
T.SL.WGBHZ014	014		

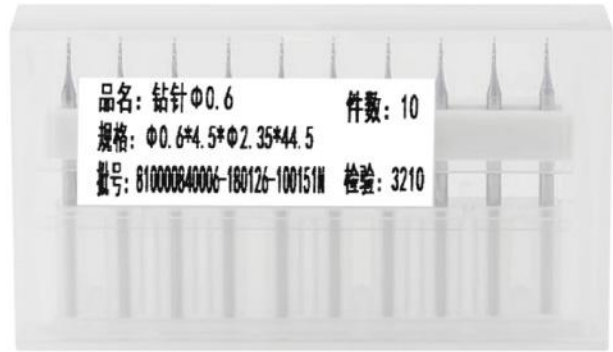

铁锤  
Gold smith hammer

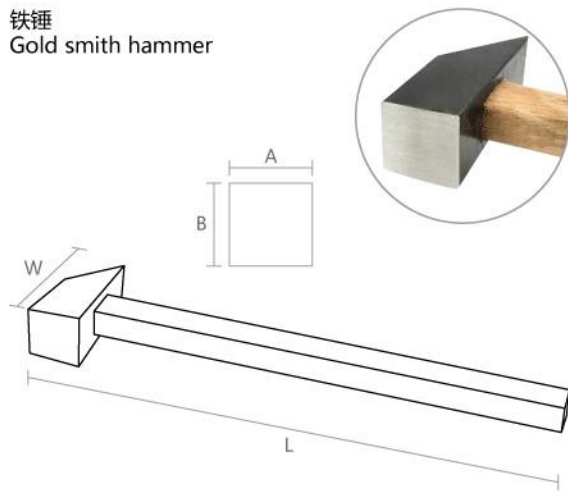

代码 Model	A	B	W	L
A T.ET.A0007	13mm	13mm	40mm	230mm
B T.ET.A0009	15mm	15mm	48mm	230mm
C T.ET.A0011	19mm	19mm	55mm	230mm
D T.ET.A0010	22mm	22mm	63mm	255mm
E T.ET.A0008	24mm	24mm	70mm	255mm



金工锤  
Chasing Hammers

代码 Model	Φ1	Φ2	H	L	重量 Weight
T.ET.A0031-1	Φ21mm	Φ35mm	55mm	275mm	0.23kg
T.ET.A0032-1	Φ26mm	Φ39mm	60mm	300mm	0.35kg
T.ET.A0033-1	Φ28mm	Φ44mm	64mm	330mm	0.45kg



金工锤  
Chasing Hammers

代码 Model	R	Φ2	H	L	重量 Weight
T.ET.A0031-2	10.5mm	Φ35mm	63mm	275mm	0.26kg
T.ET.A0032-2	13mm	Φ39mm	68mm	300mm	0.36kg
T.ET.A0033-2	16mm	Φ44mm	75mm	330mm	0.53kg



锻打横面锤  
Forging horizontal hammer

代码 Model	W	H	重量 Weight
T.ET.A0034-1	Φ32mm	105mm	700g
T.ET.A0034-2	Φ35mm	115mm	900g
T.ET.A0034-3	Φ38mm	120mm	1100g



锻打竖面锤  
Forging vertical hammer

代码 Model	W	H	重量 Weight
T.ET.A0035-1	Φ34mm	105mm	700g
T.ET.A0035-2	Φ38mm	115mm	940g
T.ET.A0035-3	Φ41mm	120mm	1100g



安装锤  
Plastic head hammer

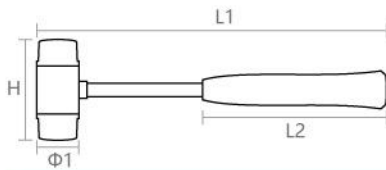

代码 Model	Φ1	H	L1	L2
T.ET.A0005	Φ25mm	65mm	235mm	125mm
T.ET.A0006	Φ30mm	75mm	255mm	135mm



T.ET.A0005



T.ET.A0006

德国猎人尼龙锤  
Germany nylon head hammer

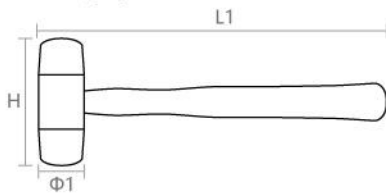

代码 Model	Φ1	H	L1	重量 Weight
T.ET.A0002	Φ22mm	70mm	255mm	135g
T.ET.A0003	Φ27mm	85mm	270mm	225g
T.ET.A0003-B	Φ27mm	85mm	270mm	225g



T.ET.A0002



T.ET.A0003



T.ET.A0003-B

篆刻锤  
Chisel hammer

代码 Model	W	H	重量 Weight
T.ET.A0036-1	20×20mm	65mm	180g
T.ET.A0036-2	Φ18mm	65mm	180g



 <p><b>美国平整锤</b> Planishing Hammer 型号 Model: T.ET.A0017-1 HMR-1 19mm &amp; 19mm</p>	 <p><b>美国宽型高起锤</b> Wide Raising Hammer 型号 Model: T.ET.A0017-2 HMR-2 20x10mm &amp; 20x8mm</p>	 <p><b>美国窄型高起锤</b> Narrow Raising Hammer 型号 Model: T.ET.A0017-3 HMR-3 20x6mm &amp; 20x5mm</p>	 <p><b>美国大号压花锤</b> Large Embossing Hammer 型号 Model: T.ET.A0017-4 HMR-4 15mm &amp; 12mm</p>
 <p><b>美国小号压花锤</b> Small Embossing Hammer 型号 Model: T.ET.A0017-5 HMR-5 5mm &amp; 3mm</p>	 <p><b>美国平整锤-单边接头</b> Plannishing Hammer w/ insert Single Ended Version 型号 Model: T.ET.A0017-6 HMR-6 19mm &amp; 19mm</p>	 <p><b>美国平整锤-双边接头</b> Double Ended Insert Hammer 型号 Model: T.ET.A0017-7 HMR-7 19mm</p>	 <p><b>美国圆头窄型高起锤</b> Rounded Narrow Raising Hammer 型号 Model: T.ET.A0017-8 HMR-8 19mm &amp; 6mm</p>
 <p><b>美国圆头款型高起锤</b> Rounded Wide Raising Hammer 型号 Model: T.ET.A0017-9 HMR-9 19x10mm &amp; 19x7mm</p>	 <p><b>美国尖纹理/高起锤</b> Sharp Texturing / Raising Hammer 型号 Model: T.ET.A0017-12 HMR-12 19x1mm &amp; 19x1.5mm</p>	 <p><b>美国短款尖纹理高起锤</b> Short Sharp Raising Hammer 型号 Model: T.ET.A0017-13 HMR-13 15x1mm &amp; 15x1.5mm</p>	 <p><b>美国生丝纹理平锤</b> Raw Silk Hammer 型号 Model: T.ET.A0017-14 HMR-14 19mm &amp; 19mm</p>
 <p><b>美国生丝十字锤</b> Raw Silk Rasing Hammer 型号 Model: T.ET.A0017-14A HMR-14A</p>	 <p><b>美国生丝宽型圆顶锤</b> Raw Silk Wide Rasing Hammer 型号 Model: T.ET.A0017-14B HMR-14B</p>	 <p><b>美国圆形纹理锤</b> Circle Texturing / Raising Hammer 型号 Model: T.ET.A0017-15 HMR-15 5mm &amp; 3mm</p>	 <p><b>美国嵌花锤</b> Chasing Hammer 型号 Model: T.ET.A0017-17 HMR-17 29mm &amp; 12mm</p>
 <p><b>美国Janus双面嵌花锤</b> Janus Chasing Hammer 型号 Model: T.ET.A0017-19 HMR-19 28x28mm</p>	 <p><b>美国经典嵌花锤-加重版</b> Classic Chasing Hammer 型号 Model: T.ET.A0017-20 HMR-20 31x13mm</p>	 <p><b>美国经典嵌花锤-普通版</b> Medium Classic Chasing Hammer 型号 Model: T.ET.A0017-20M HMR-20M 31x13mm</p>	 <p><b>美国金匠锤</b> Goldsmithing Hammer 型号 Model: T.ET.A0017-21 HMR-21 17mm &amp; 12x2mm</p>
 <p><b>美国砂岩纹理锤</b> Cross Hatch Hammer 型号 Model: T.ET.A0017-22 HMR-22 19mm</p>	 <p><b>美国平整锤</b> Planishing Hammer 型号 Model: T.ET.A0017-101 HMR-101 23mm &amp; 23mm</p>	 <p><b>美国砂美国宽型高起锤</b> Wide Raising Hammer 型号 Model: T.ET.A0017-102 HMR-102 23x12mm &amp; 23x9mm</p>	 <p><b>美国宽型十字平整锤</b> Wide Planishing Hammer 型号 Model: T.ET.A0017-102P HMR-102P</p>
 <p><b>美国窄型高起锤</b> Narrow Raising Hammer 型号 Model: T.ET.A0017-103 HMR-103 23x8mm &amp; 23x6mm</p>	 <p><b>美国大号压花锤</b> Large Embossing Hammer 型号 Model: T.ET.A0017-104 HMR-104 19mm &amp; 14mm</p>	 <p><b>美国小号压花锤</b> Small Embossing Hammer 型号 Model: T.ET.A0017-105 HMR-105 10mm &amp; 7mm</p>	 <p><b>美国压模锤</b> Blocking Hammer 型号 Model: T.ET.A0017-106 HMR-106 19x14mm</p>



美国大号双边接头锤  
Large Insert Hammer  
型号 Model: T.ET.A0017-107  
HMR-107 25mm



美国圆头窄款高起锤  
Rounded Narrow Raising Hammer  
型号 Model: T.ET.A0017-108  
HMR-108 19mm & 14mm



美国圆头宽款高起锤  
Rounded Wide Raising Hammer  
型号 Model: T.ET.A0017-109  
HMR-109 102mm



美国浅宽夹头锤-重型  
Wide Collet Hammer  
型号 Model: T.ET.A0017-110  
HMR-110



美国浅宽夹头锤-中型  
Wide Collet Med Hammer  
型号 Model: T.ET.A0017-110M  
HMR-110M



美国深宽夹头锤-重型  
Narrow Collet Hammer  
型号 Model: T.ET.A0017-111  
HMR-111



美国深宽夹头锤-中型  
Narrow Collet Med Hammer  
型号 Model: T.ET.A0017-111M  
HMR-111M



美国大号拉伸锤  
Large Stretching Hammer  
型号 Model: T.ET.A0017-301  
HMR-301 30x24mm & 30x20mm



美国窄款拉伸锤  
Narrow Stretching Hammer  
型号 Model: T.ET.A0017-302  
HMR-302 30x15mm & 30x9mm



美国牛头锤  
Bull Peen Hammer  
型号 Model: T.ET.A0017-303  
HMR-303 35mm & 30mm



美国压花锤  
Embossing Hammer  
型号 Model: T.ET.A0017-304  
HMR-304 30x20mm & 30x15mm



美国大号高起锤  
Embossing Hammer  
型号 Model: T.ET.A0017-305  
HMR-305 30x20mm & 30x15mm



美国精密史密斯平整锤  
Precisionsmith Planishing Hammer  
型号 Model: T.ET.A0017-401  
HMR-401 13x13mm



美国精密史密斯宽型高起锤  
Precisionsmith Wide Raising Hammer  
型号 Model: T.ET.A0017-402  
HMR-402 13x6mm & 13x4mm



美国精密史密斯窄型高起锤  
Precisionsmith Narrow Raising Hammer  
型号 Model: T.ET.A0017-403  
HMR-403 13x3.5mm & 13x2.5mm



美国精密史密斯大号压花锤  
Precisionsmith Large Embossing Hammer  
型号 Model: T.ET.A0017-404  
HMR-404 10x8mm



美国精密史密斯小号压花锤  
Precisionsmith Small Embossing Hammer  
型号 Model: T.ET.A0017-405  
HMR-405 4mm & 5mm



美国精密史密斯铆钉/纹理锤  
Precisionsmith Riveting / Texturing Hammer  
型号 Model: T.ET.A0017-406  
HMR-406 9mm Square & 9x1.5mm



美国精密史密斯圆头窄锤  
Precisionsmith Rounded Narrow Hammer  
型号 Model: T.ET.A0017-407  
HMR-407 14x4mm & 13x3mm



美国精密史密斯圆头宽锤  
Precisionsmith Rounded Wide Hammer  
型号 Model: T.ET.A0017-408  
HMR-408 13x6mm & 13x4.5mm



美国精密史密斯尖纹理锤  
Precisionsmith Sharp Texturing Hammer  
型号 Model: T.ET.A0017-412  
HMR-412 14x1.5mm & 14x1mm



美国精密史密斯小巧锋利锤  
Precisionsmith Sharp Petite Hammer  
型号 Model: T.ET.A0017-413  
HMR-413 6x1mm & 6x0.5mm



美国精密史密斯嵌花锤  
Precisionsmith Chasing Hammer  
型号 Model: T.ET.A0017-417  
HMR-417 21x9mm



美国Good十字纹理锤-大小面  
Micheal Good Cross Pein Hammer  
型号 Model: T.ET.A0017-C1  
CP-1 28x9mm & 18x3mm



美国Good平整锤-中号面  
Micheal Good Cross Pein Hammer  
型号 Model: T.ET.A0017-C2  
CP-2 24x4mm & 22x3mm



美国Good平整锤-中号面  
Micheal Good Planishing Hammer  
型号 Model: T.ET.A0017-P1  
P-1 20x12.5mm



美国嵌花/铆钉锤  
Chasing Riveting Hammer  
型号 Model: T.ET.A0017-RC  
R-CR



美国金匠/十字头锤  
Goldsmithing / Cross Pein Hammer  
型号 Model: T.ET.A0017-RG  
R-GF



美国1号平整/十字锤  
Riveting Hammer

型号 Model: T.ET.A0017-N1  
NTAH-1



美国2号尖纹理/十字锤  
Double Crosspein Hammer

型号 Model: T.ET.A0017-N2  
NTAH-2



美国3号双圆头锤  
Double Ballpein Hammer

型号 Model: T.ET.A0017-N3  
NTAH-3



美国小号冲压锤  
Stamping Hammer

型号 Model: T.ET.A0017-S1  
STH-1



美国中号冲压锤  
Medium Stamping Hammer

型号 Model: T.ET.A0017-S2  
STH-2



美国大号压花锤  
Large Stamping Hammer

型号 Model: T.ET.A0017-S3  
STH-3



美国篆刻锤套装  
Set HMR1-5  
型号 Model: T.ET.SET001



美国篆刻锤套装  
Set HMR-101 thru 105  
型号 Model: T.ET.SET002



美国篆刻锤套装  
Set HMR-401 thru 405  
型号 Model: T.ET.SET003



美国Michale Good锤子套装  
Chasing Hammers Set  
Set HMR-G 型号 Model: T.ET.SET004



美国嵌花锤套装  
Micheal Good Hammers  
Set HMR-C 型号 Model: T.ET.SET005



美国纹理锤  
Texture Hammers  
Set HMR-T 型号 Model: T.ET.SET006



美国大师精密史密斯锤子套装  
Smaster Precision Smith Hammers Set  
Set HMR-PH 型号 Model: T.ET.SET007



美国大师珠宝成型锤套装  
Master Jewelry Forming  
Set HMR-M 型号 Model: T.ET.SET008



美国银器锻造套装  
Silver Smithing And Forming  
Set HMR-S 型号 Model: T.ET.SET009



美国制造锤套装  
Set HMR-1 thru 5  
MKR1-5 型号 Model: T.ET.SET010



美国制造锤套装  
Set HMR-401 thru 405  
MKR401-405 型号 Model: T.ET.SET011



美国DVD及工具锤子套装  
基础敲击成型-手镯  
Basic Hammering and Forming  
Video-Cuff Bracelets  
JA-1 SET 型号 Model: T.ET.SET012



美国DVD及工具锤子套装  
基础敲击成型-吊坠  
Hammering and Forming Jewelry  
Pendants Video Tool Set  
JA-2 SET 型号 Model: T.ET.SET013



美国DVD及工具锤子套装  
基础敲击成型-吊坠  
Hammering and Forming Jewelry  
Pendants Video Tool Set  
JA-2 SET 型号 Model: T.ET.SET013



美国DVD及工具锤子套装  
进阶边框成型  
Expert Bezel Forming Video  
Tool Set  
JA-3 SET 型号 Model: T.ET.SET014



美国DVD及工具锤子套装  
成形空心杯  
Forming Hollow Rings Video  
Tool Set  
JA-4 SET 型号 Model: T.ET.SET015



美国DVD及工具锤子套装  
基础敲击成型-手镯及吊坠  
Basic Jewelry Hammering and  
Forming Video Cuff Bracelets and  
Pendants  
JA-5 SET 型号 Model: T.ET.SET016



美国DVD及工具锤子套装  
基础敲击成型-手镯及吊坠  
边框及空心杯  
Basic Jewelry Hammering and  
Forming Video Cuff Bracelets,  
Pendants, Bezel Forming and  
Hollow Ring  
JA-6 SET 型号 Model: T.ET.SET017



美国DVD及工具锤子套装  
锤击纹理及成型  
Lapidary Journal-Jewelry Artist  
Video Hammer Textures and Forms  
JA-7 SET 型号 Model: T.ET.SET018



美国DVD及工具锤子套装  
宽凸袖口  
Wide Convex Cuff Video  
Tool Set  
FP-1 SET 型号 Model: T.ET.SET019

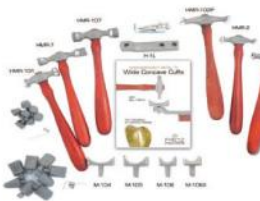

美国DVD及工具锤子套装  
宽凹袖口  
Wide Concave Video Tool Set  
FP-2 SET 型号 Model: T.ET.SET020



美国DVD及工具锤子套装  
宽凹袖口  
Wide Concave Video and Convex  
Cuff Video Master Tool Set  
FP-3 SET 型号 Model: T.ET.SET021

肌理锤  
Texture Hammer

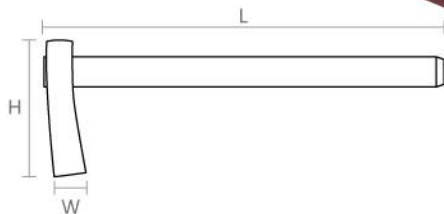
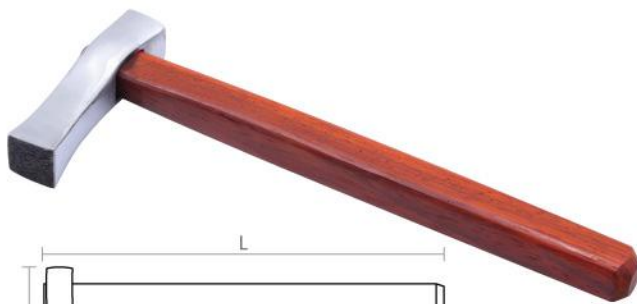

代码 Model	W	H	L
A T.ET.A0030-1	23×23mm	83mm	270mm
B T.ET.A0030-2	23×23mm	83mm	270mm
C T.ET.A0030-3	23×23mm	83mm	270mm
D T.ET.A0030-4	23×23mm	83mm	270mm
E T.ET.A0030-5	23×23mm	83mm	270mm
F T.ET.A0030-6	23×23mm	83mm	270mm



A



B



C



D



E



F

吉言鑿  
Auspicious chisel  
T.JK.00015



74x12x10mm  
10x7mm



75x10x10mm  
8x7mm



75x10x8mm  
8x7mm



72x8x8mm  
6x5mm



73x10x10mm  
9x7mm



71x10x10mm  
8x8mm



72x6x6mm  
4x3mm



72x6x6mm  
5x5mm



73x10x10mm  
9x9mm



71x10x10mm  
8x7mm



73x8x8mm  
7x6mm



72x10x8mm  
8x7mm



73x10x6mm  
8x5mm



73x6x6mm  
5x3mm



76x6x6mm  
5x5mm



73x8x6mm  
7x5mm



72x6x6mm  
5x3mm



72x6x6mm  
4x4mm



73x12x8mm  
11x7mm



73x12x8mm  
11x7mm



73x10x6mm  
8x5mm



73x10x6mm  
8x5mm



73x10x6mm  
8x5mm



73x10x6mm  
8x5mm



73x10x6mm  
8x5mm





黄财神  
Yellow God of Wealth



型号 Model	尺寸 Size
T.JK.00019-13	Φ13mm
T.JK.00019-15	Φ15mm
T.JK.00019-18	Φ18mm
T.JK.00019-20	Φ20mm
T.JK.00019-22	Φ22mm
T.JK.00019-25	Φ25mm
T.JK.00019-28	Φ28mm
T.JK.00019-30	Φ30mm
T.JK.00019-32	Φ32mm
T.JK.00019-35	Φ35mm

绿财神  
Green God of Wealth



型号 Model	尺寸 Size
T.JK.00023-15	Φ15mm
T.JK.00023-18	Φ18mm
T.JK.00023-20	Φ20mm
T.JK.00023-25	Φ25mm
T.JK.00023-28	Φ28mm
T.JK.00023-30	Φ30mm
T.JK.00023-32	Φ32mm
T.JK.00023-35	Φ35mm

红财神  
Red God of Wealth



型号 Model	尺寸 Size
T.JK.00022-15	Φ15mm
T.JK.00022-18	Φ18mm
T.JK.00022-20	Φ20mm
T.JK.00022-25	Φ25mm
T.JK.00022-28	Φ28mm
T.JK.00022-30	Φ30mm
T.JK.00022-32	Φ32mm
T.JK.00022-35	Φ35mm

白财神  
White God of Wealth



型号 Model	尺寸 Size
T.JK.00024-15	Φ15mm
T.JK.00024-18	Φ18mm
T.JK.00024-20	Φ20mm
T.JK.00024-25	Φ25mm
T.JK.00024-28	Φ28mm
T.JK.00024-30	Φ30mm
T.JK.00024-32	Φ32mm
T.JK.00024-35	Φ35mm

黑财神  
Black God of Wealth



型号 Model	尺寸 Size
T.JK.00020-15	Φ15mm
T.JK.00020-18	Φ18mm
T.JK.00020-20	Φ20mm
T.JK.00020-22	Φ22mm
T.JK.00020-25	Φ25mm
T.JK.00020-28	Φ28mm
T.JK.00020-30	Φ30mm
T.JK.00020-32	Φ32mm
T.JK.00020-35	Φ35mm

八宝罗盘  
Eight Treasures Compass



型号 Model	尺寸 Size
T.JK.00029-15	Φ15mm
T.JK.00029-18	Φ18mm
T.JK.00029-20	Φ20mm
T.JK.00029-22	Φ22mm
T.JK.00029-25	Φ25mm
T.JK.00029-28	Φ28mm
T.JK.00029-30	Φ30mm
T.JK.00029-32	Φ32mm
T.JK.00029-35	Φ35mm

佛公  
Mold of Buddha statue



型号 Model	尺寸 Size
T.JK.00027-15	Φ15mm
T.JK.00027-18	Φ18mm
T.JK.00027-20	Φ20mm
T.JK.00027-22	Φ22mm
T.JK.00027-25	Φ25mm
T.JK.00027-28	Φ28mm
T.JK.00027-32	Φ32mm

喜旋纹  
Mold of Swirling pattern



型号 Model	尺寸 Size
T.JK.00028-15	Φ15mm
T.JK.00028-18	Φ18mm
T.JK.00028-20	Φ20mm
T.JK.00028-22	Φ22mm
T.JK.00028-25	Φ25mm
T.JK.00028-28	Φ28mm
T.JK.00028-32	Φ32mm

千手观音  
Mold of The Eight Guardian Deities - Thousand-Armed Guanyin



型号 Model	尺寸 Size
T.JK.00025-1-20	Φ20mm
T.JK.00025-1-25	Φ25mm
T.JK.00025-1-30	Φ30mm

阿弥陀佛  
Mold of The Eight Guardian Deities - Amitabha Buddha



型号 Model	尺寸 Size
T.JK.00025-2-20	Φ20mm
T.JK.00025-2-25	Φ25mm
T.JK.00025-2-30	Φ30mm

大势至菩萨  
Mold of The Eight Guardian Deities - Mahasthamaprapta Bodhisattva



型号 Model	尺寸 Size
T.JK.00025-7-20	Φ20mm
T.JK.00025-7-25	Φ25mm
T.JK.00025-7-30	Φ30mm

虚空藏菩萨  
Mold of The Eight Guardian Deities - Akasagarbha Bodhisattva



型号 Model	尺寸 Size
T.JK.00025-8-20	Φ20mm
T.JK.00025-8-25	Φ25mm
T.JK.00025-8-30	Φ30mm

不动明王  
Mold of The Eight Guardian Deities - Acala (Fudo Myoo)



型号 Model	尺寸 Size
T.JK.00025-3-20	Φ20mm
T.JK.00025-3-25	Φ25mm
T.JK.00025-3-30	Φ30mm

大日如来  
Mold of The Eight Guardian Deities - Vairocana Buddha



型号 Model	尺寸 Size
T.JK.00025-4-20	Φ20mm
T.JK.00025-4-25	Φ25mm
T.JK.00025-4-30	Φ30mm

文殊观音  
Mold of The Eight Great Guardian Deities - Manjushri and Avalokiteshvara



型号 Model	尺寸 Size
T.JK.00025-5-20	Φ20mm
T.JK.00025-5-25	Φ25mm
T.JK.00025-5-30	Φ30mm

普贤菩萨  
Mold of The Eight Great Guardian Deities - Samantabhadra Bodhisattva



型号 Model	尺寸 Size
T.JK.00025-6-20	Φ20mm
T.JK.00025-6-25	Φ25mm
T.JK.00025-6-30	Φ30mm

山鬼钱币模具  
Mold of Mountain Ghost Coin

型号 Model: T.JK.00040-28  
尺寸 Size: Φ28mm



正面  
Obverse



正面  
Reverse



打金模具  
Gold stamping molds

多种规格和图案可选  
Various specifications and patterns available

扇形-祥云无事牌无边  
Fan-shaped auspicious cloud design, borderless pendant

型号 Model: T.JK.00031

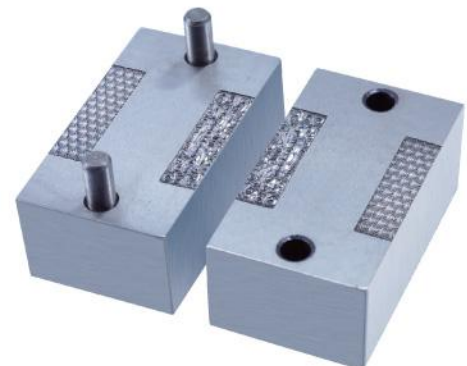
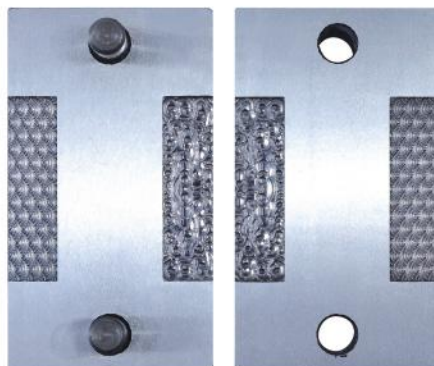

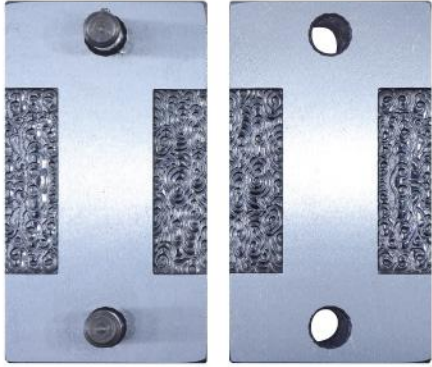

双祥云-无事牌无边  
Double Auspicious Clouds - Plain Pendant (Borderless)  
型号 Model: T.JK.00032

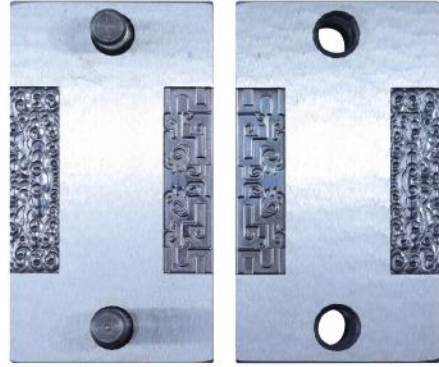

草龙-无事牌无边  
Grass Dragon - Plain Pendant (Borderless)  
型号 Model: T.JK.00033

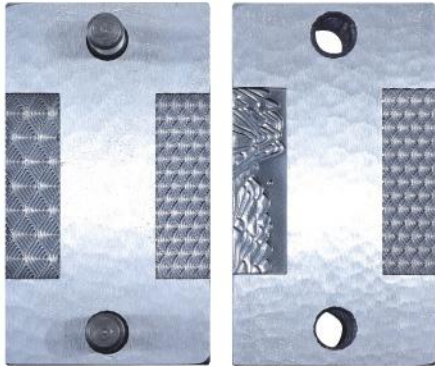

山河-无事牌无边  
Mountains and Rivers - Plain Pendant (Borderless)  
型号 Model: T.JK.00034



黄财神-麒麟合模  
Combined Mold set of Yellow God of Wealth - Qilin  
型号 Model: T.JK.00035

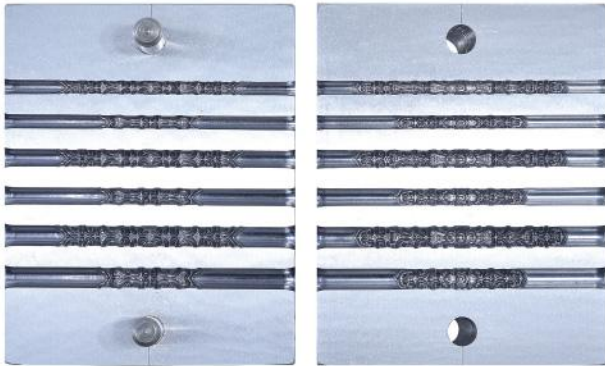

卷草3.5-4.5-5.5  
Scrollwork 3.5-4.5-5.5  
型号 Model: T.JK.00036

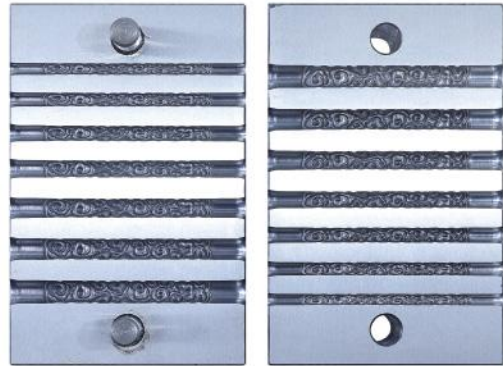

祥云金箍棒手镯  
Auspicious Cloud Golden Hoop Bangle  
型号 Model: T.JK.00038

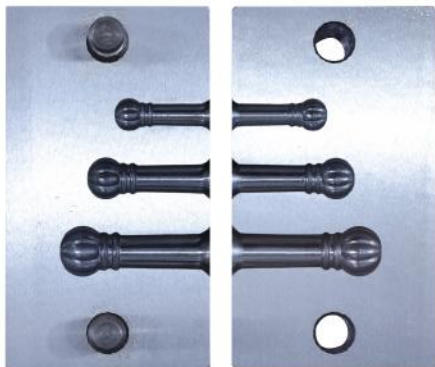

南瓜头三合一  
Pumpkin Head Three-in-One  
型号 Model: T.JK.00037

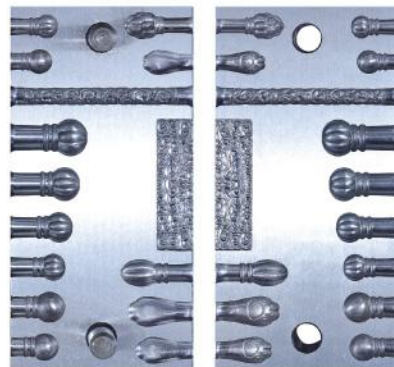

南瓜头十五合一  
Pumpkin Head Fifteen-in-One  
型号 Model: T.JK.00039

圆头唐草鏰子  
Tang Grass/Tang Pattern Carving Knife

代码 Model	长度 Length	头部宽度 Head width
TJK.00010-1	90mm	2mm
TJK.00010-2	90mm	3mm
TJK.00010-3	90mm	4mm
TJK.00010-4	90mm	5mm
TJK.00010-5	90mm	6mm
TJK.00010-6	90mm	7mm
TJK.00010-7	90mm	8mm
TJK.00010-8	90mm	9mm
TJK.00010-9	90mm	10mm



花鏰  
Flower chisel



代码 Model	编号 Number	代码 Model	编号 Number	代码 Model	编号 Number	代码 Model	编号 Number	代码 Model	编号 Number
TJK.00011-1	A1	TJK.00011-14	A14	TJK.00011-27	B7	TJK.00011-40	B20	TJK.00011-53	C13
TJK.00011-2	A2	TJK.00011-15	A15	TJK.00011-28	B8	TJK.00011-41	C1	TJK.00011-54	C14
TJK.00011-3	A3	TJK.00011-16	A16	TJK.00011-29	B9	TJK.00011-42	C2	TJK.00011-55	C15
TJK.00011-4	A4	TJK.00011-17	A17	TJK.00011-30	B10	TJK.00011-43	C3	TJK.00011-56	C16
TJK.00011-5	A5	TJK.00011-18	A18	TJK.00011-31	B11	TJK.00011-44	C4	TJK.00011-57	C17
TJK.00011-6	A6	TJK.00011-19	A19	TJK.00011-32	B12	TJK.00011-45	C5	TJK.00011-58	C18
TJK.00011-7	A7	TJK.00011-20	A20	TJK.00011-33	B13	TJK.00011-46	C6	TJK.00011-59	C19
TJK.00011-8	A8	TJK.00011-21	B1	TJK.00011-34	B14	TJK.00011-47	C7	TJK.00011-60	C20
TJK.00011-9	A9	TJK.00011-22	B2	TJK.00011-35	B15	TJK.00011-48	C8	TJK.00011-61	C21
TJK.00011-10	A10	TJK.00011-23	B3	TJK.00011-36	B16	TJK.00011-49	C9	TJK.00011-62	C22
TJK.00011-11	A11	TJK.00011-24	B4	TJK.00011-37	B17	TJK.00011-50	C10	TJK.00011-63	C23
TJK.00011-12	A12	TJK.00011-25	B5	TJK.00011-38	B18	TJK.00011-51	C11		
TJK.00011-13	A13	TJK.00011-26	B6	TJK.00011-39	B19	TJK.00011-52	C12		

## 篆刻刀 Chisel carving knife

代码 Model	形状 Shape	代码 Model	形状 Shape
T.JK.00006-1	细直线 Fine straight line 1mm	T.JK.00006-13	深曲 Deep curvature 2mm
T.JK.00006-2	细直线 Fine straight line 3mm	T.JK.00006-14	深曲 Deep curvature 3mm
T.JK.00006-3	细直线 Fine straight line 5mm	T.JK.00006-15	深曲 Deep curvature 5mm
T.JK.00006-4	细直线 Fine straight line 7mm	T.JK.00006-16	半圆压鏢 Half circle chisel 2mm
T.JK.00006-5	粗直线 Thick straight line 1mm	T.JK.00006-17	三角压鏢 Triangular chisel 1×3mm
T.JK.00006-6	粗直线 Thick straight line 5mm	T.JK.00006-18	椭圆压鏢 Elliptical chisel 3×4mm
T.JK.00006-7	平曲 Flat curvature 2mm	T.JK.00006-19	方形压鏢 Square chisel 2×2mm
T.JK.00006-8	平曲 Flat curve 3mm	T.JK.00006-20	空心点鏢 Hollow point chisel 1mm
T.JK.00006-9	平曲 Flat curve 5mm	T.JK.00006-21	空心点鏢 Hollow point chisel 2mm
T.JK.00006-10	中曲 Medium curvature 2mm	T.JK.00006-22	空心点鏢 Hollow point chisel 3mm
T.JK.00006-11	中曲 Medium curvature 3mm	T.JK.00006-23	空心点鏢 Solid point chisel 1mm
T.JK.00006-12	中曲 Mid curve 5mm	T.JK.00006-24	空心点鏢 Solid point chisel 2mm



尺寸Size: Φ5.5×90mm

## 唐草/唐纹篆刻刀 Tang Grass/Tang Pattern Carving Knife

代码 Model	形状 Shape	代码 Model	形状 Shape
T.JK.00009-1	左 Left 2mm	T.JK.00009-9	左 Left 6mm
T.JK.00009-2	右 Right 2mm	T.JK.00009-10	右 Right 6mm
T.JK.00009-3	左 Left 3mm	T.JK.00009-11	左 Left 8mm
T.JK.00009-4	右 Right 3mm	T.JK.00009-12	右 Right 8mm
T.JK.00009-5	左 Left 4mm	T.JK.00009-13	左 Left 10mm
T.JK.00009-6	右 Right 4mm	T.JK.00009-14	右 Right 10mm
T.JK.00009-7	左 Left 5mm	T.JK.00009-15	左 Left 12mm
T.JK.00009-8	右 Right 5mm		



## 圆铁平砧 Round iron anvil

代码 Model	直径 Diameter	厚度 Thickness	重量 Weight	代码 Model	直径 Diameter	厚度 Thickness	重量 Weight
T.JK.00012-1	Φ110mm	4mm	3kg	T.JK.00012-7	Φ160mm	4mm	6.6kg
T.JK.00012-2	Φ110mm	4.7mm	3.5kg	T.JK.00012-8	Φ160mm	4.5mm	7kg
T.JK.00012-3	Φ120mm	4mm	3.5kg	T.JK.00012-9	Φ160mm	6mm	9.3kg
T.JK.00012-4	Φ130mm	4mm	4.2kg	T.JK.00012-10	Φ180mm	6mm	12kg
T.JK.00012-5	Φ140mm	4mm	4.6kg	T.JK.00012-11	Φ200mm	6mm	14.5kg
T.JK.00012-6	Φ150mm	4mm	6.4kg				



方铁平砧  
Square iron anvil  
T.JK.00012-12  
115×115×40mm 4kg



纹底鏢刀  
Pattern bottom chisel knife  
T.JK.00013  
Φ5×90mm 13 Pcs



首饰篆刻台(铁)  
Jewelry carving table (Iron)  
T.JK.00007  
240×130×40mm 8kg



首饰篆刻台(不锈钢)  
Jewelry carving table (Stainless steel)  
T.JK.00007-2  
240×130×40mm 16kg



旋转篆刻台  
Rotating chiseling table  
TT.JK.00007-3  
210×150×45mm 9.5kg



松香胶板(木质)-黄胶  
Rosin gum board (wood) - yellow gum  
T.JK.00008-1  
320×285mm



松香胶板(木质)-黄胶  
Rosin gum board (wood) - yellow gum  
T.JK.00008-2  
280×190×33mm 1.8kg



松香胶板(木质)-黄胶  
Rosin gum board (wood) - yellow gum  
T.JK.00008-3  
230×230×33mm 1.8kg



松香胶板(木质)-黑胶  
Rosin gum board (wood) - black gum  
T.JK.00008-3  
280×190×33mm 1.8kg



松香胶板(木质)-黑胶  
Rosin gum board (wood) - black gum  
T.JK.00008-4  
230×230×33mm 1.8kg



松香胶板(白铁)-黄胶  
Rosin gum board (iron) - yellow gum  
T.JK.00008-5  
280×190×33mm 4.2kg



松香胶板(白铁)-黄胶  
Rosin gum board (iron) - yellow gum  
T.JK.00008-6  
230×230×33mm 4.2kg



松香胶板(白铁)-黑胶  
Rosin gum board (iron) - black gum  
T.JK.00008-7  
280×190×33mm 1.8kg



松香胶板(白铁)-黑胶  
Rosin gum board (iron) - black gum  
T.JK.00008-8  
230×230×33mm 1.8kg

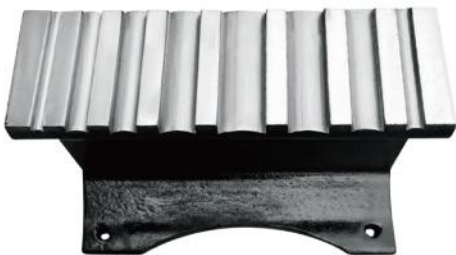

手镯槽  
Bracelet groove  
T.JK.00014  
L180×W60mm 5kg



国产油石  
Polishing stone

T.GI.00041	4"	100×50×12mm
T.GI.00146	5"	125×50×12mm
T.GI.00040	6"	150×50×12mm



不锈钢手环  
Bangle mandrel-stainless steel  
T.CG.00068  
椭圆形 Oval 42×35mm, 81×63mm  
长度 Length: 280mm Weight: 1kg



不锈钢手环  
Bangle mandrel-stainless steel  
T.CG.00097  
圆形 Circular Φ72mm, Φ38mm  
长度 Length: 280mm Weight: 1kg



铜手环  
Bangle mandrel-copper  
T.CG.00081  
圆形 Circular Φ72mm, Φ38mm  
长度 Length: 280mm Weight: 1kg



铜手环  
Bangle mandrel-copper  
T.CG.00080  
椭圆形 Oval 40×32mm, 82×66mm  
长度 Length: 280mm Weight: 1kg



木手环  
Bangle mandrel-wood  
T.GI.00045  
椭圆形 Oval



木手环  
Bangle mandrel-copper  
T.CG.00039  
圆形 Circular



塑料手环  
Bangle mandrel-plastic  
T.CG.00110  
椭圆形 Oval Φ79mm, Φ40mm  
长度 Length: 297mm Weight: 380g



塑料手环  
Bangle mandrel-plastic  
T.CG.00109  
圆形 Circular Φ79mm, Φ36mm  
长度 Length: 307mm Weight: 460g



塑料刻度手环  
Bangle mandrel-plastic  
T.CG.00163  
圆形 Circular Φ77mm, Φ35mm  
长度 Length: 300mm Weight: 370g



梯形手环  
Bangle mandrel-wood  
T.CG.00113  
圆形 Circular Φ68mm, Φ40mm  
长度 Length: 294mm Weight: 445g



戒指木  
Bangle mandrel-wood  
T.GI.00071



方形戒指木  
Bangle mandrel-wood  
T.CG.00235



中黄胶锤  
Yellow plastic head hammer  
T.ET.A0004



台木  
Bench pin  
T.CG.00001



红木台塞  
Bench pin  
T.CG.00042

铁马铁砧  
Iron horse and anvil



字印 (可订制)  
Stamp (tailored)

代码 Model	直径 Diameter
T.CG.ZY001	14K曲字印 14K stamp
T.CG.ZY002	18K曲字印 18K stamp
T.CG.ZY003	999曲字印 999 stamp
T.CG.ZY004	925曲字印 925 stamp
T.CG.ZY006	数字字印 Digit stamp
T.CG.ZY007	16K字印 16K stamp
T.CG.ZY008	24K字印 24K stamp
T.CG.ZY009	797字印 797stamp
T.CG.ZY017-B	916字印 916 stamp
T.CG.ZY018-B	750字印 750 stamp
T.CG.ZY019-B	21K字印 21K stamp
T.CG.ZY020-B	9K字印 9K stamp
T.CG.ZY021	950字印 950 stamp



蜂窝状石英焊板  
Honeycomb ceramic soldering plate  
C.CS.135095002-W  
137×97×13mm 150g

数字字印  
Digit stamp

代码 Model	字高 Font height
T.CG.ZY022-1	1.5mm
T.CG.ZY022-2	2.0mm
T.CG.ZY022-3	2.5mm
T.CG.ZY022-4	3.0mm
T.CG.ZY022-5	4.0mm
T.CG.ZY022-6	5.0mm
T.CG.ZY022-7	6.0mm

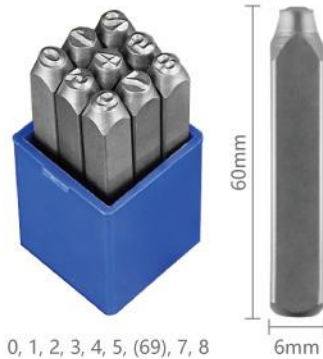

0, 1, 2, 3, 4, 5, (69), 7, 8

字母字印  
Letter stamp

代码 Model	字高 Font height
T.CG.ZY023-1	1.5mm
T.CG.ZY023-2	2.0mm
T.CG.ZY023-3	2.5mm
T.CG.ZY023-4	3.0mm
T.CG.ZY023-5	4.0mm
T.CG.ZY023-6	5.0mm
T.CG.ZY023-7	6.0mm
T.CG.ZY023-8	8.0mm



ABCDEFGHIJKLMNOPQRSTUVWXYZ&



万能微镶机  
Zoom stereo stone setting microscope  
M.MS.WX002



微镶机  
Setting microscope  
M.MS.WX003



微镶机  
Setting microscope  
M.MS.WX005



多角度伸缩微镶机  
Flexible arm zoom stereo microscope  
M.MS.WX001



热能微镶机  
Thermal micro setting  
M.MS.WX004

小型万能镶石座  
Small engraver's block



T.GI.00002 1.5KG



T.GI.00002-1 1.5KG



T.GI.00001-4 1.5KG



T.GI.00067



T.GI.0023-7 13KG



T.GI.00001-5 1.5KG



高精度万能镶石座  
High-precision engraver's block  
T.GI.00152 10KG



高精度万能镶石座  
High-precision engraver's block  
Model: T.GI.00023-B 10KG



高精度万能镶石座  
High-precision engraver's block  
T.GI.00023-C 11KG



多角度的活动万能镶石座  
Multi-angle & adjustable engraver's block  
T.GI.00001-2 17KG



韩式万能镶石座  
Korean engraver's block  
T.GI.00001-3 12KG



万能镶石座  
Engraver's block  
T.GI.00001 8.5KG

不锈钢微镶实心球  
SS micro setting solid ball



T.GI.00068-1  
2#-13#/13-22mm 1.3KG



T.GI.00068-2  
2#-13#/13-22mm 1.3KG



T.GI.00004  
1.3KG



T.GI.00068  
2#-13#/13-22mm 1.4KG



木柄微镶戒指套(黑)  
Wooden handle ring holder for  
stone setting (black)  
T.GI.00069  
2#-13#/13-22mm



木柄微镶戒指套(白)  
Wooden handle ring holder for  
stone setting (white)  
T.GI.00070  
2#-13#/13-22mm



铝柄微镶戒指套  
Aluminum handle ring holder  
for stone setting  
T.GI.00070-2  
2#-13#/13-22mm



活动调节固定戒指器 (黑色)  
Adjustable and fixed ring device (black)  
T.GI.00242



活动调节固定戒指器 (白色)  
Adjustable and fixed ring device (white)  
T.GI.00242-W



微镶戒指套  
Ring holder for stone setting  
T.GI.00003



手批戒指夹  
Hand ring clamp  
T.GI.1023-5 0.8KG



万能戒指夹  
Engraver's ring clamp  
T.GI.1021-3



铝合金金属戒指夹  
Aluminum alloy ring clamp  
T.GI.00070-3



活动戒指夹  
Adjustable ring clamp  
T.GI.01030 2.4KG

活动戒指夹-微钻套装  
Adjustable ring clamp -stone setting set



T.GI.00243-1 3.3kg



T.GI.00243 3.5kg

四方窩砧  
Square steel dapping block



T.GI.00058



T.GI.00058-1



T.GI.00058-2



T.GI.00222



T.GI.00222-1



T.GI.00057



T.GI.00222-T



T.GI.00222-1-T



T.GI.00057-T



T.GI.00057-M

型号 Model	名称 Designation	尺寸 Size	重量 Weight	内腔尺寸 Cavity Size (mm)
T.GI.00222	四方窩砧 Square steel dapping block	25×25×25mm	0.11 kg	3, 4, 5, 6, 7, 8, 9, 10, 11, 12, 13, 14
T.GI.00222-1	四方窩砧 Square steel dapping block	38×38×38mm	0.3kg	4, 5, 6, 7, 8, 9, 10, 11, 12, 13, 14, 15, 16, 17, 18, 19, 22, 25, 30
T.GI.00057	四方窩砧 Square steel dapping block	50×50×50mm	0.66kg	3, 4, 5, 6, 7, 8, 9, 10, 11, 12, 13, 14, 15, 16, 17, 18, 20, 22, 24, 26, 28, 31, 35, 39
T.GI.00058	四方窩砧 Square steel dapping block	63×63×63mm	1.4kg	5, 6, 7, 8, 9, 10, 11, 12, 13, 14, 15, 16, 17, 18, 19, 20, 25, 28, 35, 40, 45, 50
T.GI.00058-1	四方窩砧 Square steel dapping block	70×70×70mm	1.76kg	4, 5, 6, 7, 8, 9, 10, 11, 12, 13, 14, 15, 16, 18, 20, 22, 25, 30, 35, 40, 45, 50
T.GI.00058-2	四方窩砧 Square steel dapping block	120×120×120mm	8kg	2, 3, 4, 5, 6, 7, 8, 9, 10, 11, 12, 13, 14, 15, 16, 17, 18, 19, 20, 22, 24, 26, 28, 30, 32, 34, 36, 38, 40, 50, 60, 70, 80, 90, 100
T.GI.00222-T	铜四方窩砧 Copper Square steel dapping block	25×25×25mm	0.11 kg	3, 4, 5, 6, 7, 8, 9, 10, 11, 12, 13, 14
T.GI.00222-1-T	铜四方窩砧 Copper square steel dapping block	38×38×38mm	0.3kg	4, 5, 6, 7, 8, 9, 10, 11, 12, 13, 14, 15, 16, 17, 18, 19, 22, 25, 30
T.GI.00057-T	铜四方窩砧 Copper Square steel dapping block	50×50×50mm	0.66kg	3, 4, 5, 6, 7, 8, 9, 10, 11, 12, 13, 14, 15, 16, 17, 18, 20, 22, 24, 26, 28, 31, 35, 39
T.GI.00057-M	木四方窩砧 Wood square steel dapping block	60×60×60mm	/	11, 12, 13, 14, 15, 16, 17, 18, 19, 20, 25, 30, 35, 40, 45, 50

扁窝砧  
Flat dapping block



T.GI.00065



T.GI.00065-B



T.GI.00066



T.GI.00066-B



T.GI.00066-C

型号 Model	名称 designation	尺寸 Size	重量 Weight	内腔尺寸 Cavity Size (mm)
T.GI.00065	小扁窝砧 Flat steep dapping block	100×60×20mm	0.8kg	4, 5, 6, 7, 8, 9, 10, 11, 12, 13, 14, 16, 18, 20
T.GI.00065-B	小扁窝砧 Flat steep dapping block	60×100×20mm	0.9kg	2, 2.5, 3, 3.5, 4, 4.5, 5, 5.5, 6, 6.5, 7, 7.5, 8, 8.5, 9, 9.5, 10
T.GI.00066	大扁窝砧 Flat steep dapping block	100×60×30mm	1.55kg	2, 3, 4, 5, 6, 7, 8, 9, 10, 11, 12, 13, 14, 16, 18, 20
T.GI.00066-B	大扁窝砧 Flat steep dapping block	200×170×30mm	6.8kg	2, 3, 4, 5, 6, 7, 8, 9, 10, 11, 12, 13, 14, 15, 16, 17, 18, 19, 21, 22, 23, 24, 25, 26, 27, 28, 29, 30, 31, 32, 34, 36, 38
T.GI.00066-C	大扁窝砧 Flat steep dapping block	150×130×30mm	3.5kg	2, 3, 4, 5, 6, 7, 8, 9, 10, 11, 12, 13, 14, 15, 16, 17, 18, 19, 21, 22, 23, 24, 25, 26, 27, 28, 29, 30, 31, 32

坑铁  
Dapping block



小坑铁  
Small dapping block  
T.RC.RR018  
32×32×205mm 1.35kg



大坑铁  
Big dapping block  
T.RC.RR019  
38×38×205mm 1.9kg



特大坑铁  
Extra Big dapping block  
T.RC.RR101  
205×100×35mm 4.8kg



特大四面坑铁  
Extra Big Dapping block  
with 4 sides  
T.RC.RR102  
50×50×150mm 2.7kg



四方坑铁  
Dapping block  
T.RC.RR103  
60×60×60mm 1.3kg



窝珠作 (冲头) 15支装  
Dapping punches (15 Pcs)

T.CG.00003 1.7kg  
内腔尺寸 Cavity Size (mm): 4, 5, 6, 7, 8, 9, 10, 11, 12, 13, 14, 15, 16, 17, 18



窝珠作 (冲头) 17支装  
Dapping punches (17 Pcs)

T.CG.00108 0.8kg  
内腔尺寸 Cavity Size (mm): 2, 2.5, 3, 3.5, 4, 4.5, 5, 5.5, 6, 6.5, 7, 7.5, 8, 8.5, 9, 9.5, 10



套装窝珠作 (冲头) 8支装  
Punch dapping set (8 Pcs)

T.CG.00167 3.3kg  
内腔尺寸 Cavity Size (mm): 5, 8, 11, 14, 17, 19, 25, 28



套装窝珠作 (冲头) 24支装  
Punch dapping set (24 Pcs)

T.CG.00168-A 5.5kg  
内腔尺寸 Cavity Size (mm): 2, 3, 4, 5, 6, 7, 8, 9, 10, 11, 12, 13, 14, 15, 16, 17, 18, 19, 20, 23, 25, 28, 32, 36



套装组合窝珠作 (冲头) 25支  
Punch dapping set (25 Pcs)

T.CG.00168-B 12kg  
内腔尺寸 Cavity Size (mm): 5, 6, 7, 8, 9, 10, 11, 12, 13, 14, 15, 16, 17, 18, 19, 21, 23, 25, 28, 30, 32, 35, 40, 45, 50



英国窝铁套装  
Dapping bead

T.GI.00233 10.5kg  
内腔尺寸 Cavity Size (mm): 50, 57, 63, 70, 76, 82



套装窝珠作 (冲头) 12支装  
Dapping bead (12 Pcs)

T.CG.00170 1.1kg  
内腔尺寸 Cavity Size (mm): 3.5, 4, 4.5, 5, 5.5, 6, 6.5, 7, 7.5, 8, 9, 10, 11, 12, 13



量珠棍套装24支装  
Dapping bead (24 Pcs)

T.CG.00171 2kg  
内腔尺寸 Cavity Size (mm): 2, 2.5, 3, 3.5, 4, 4.5, 5, 5.5, 6, 6.5, 7, 7.5, 8, 8.5, 9, 10, 11, 12, 13, 14, 15, 16, 17, 18



套装窝珠作 (冲头) 12支装  
Dapping bead (12 Pcs)

T.CG.00172 1.2kg  
内腔尺寸 Cavity Size (mm): 1, 2, 3, 4, 5, 6, 7, 8, 9, 10, 11, 12



特大窝珠作套装  
Dapping bead

T.CG.00174 18kg  
内腔尺寸 Cavity Size (mm): 2, 2.5, 3, 3.5, 4, 4.5, 5, 5.5, 6, 6.5, 7, 7.5, 8, 8.5, 9, 9.5, 10, 11, 12, 13, 14, 15, 16, 17, 18, 19, 20, 21, 23, 25, 28, 30, 32, 35, 36, 40, 45, 50



特大窝珠作套装  
Dapping bead

T.CG.00169 24kg  
内腔尺寸 Cavity Size (mm): 4, 5, 6, 7, 8, 9, 10, 11, 12, 13, 14, 15, 16, 17, 18, 25, 28, 32, 36, 40, 45, 50



椭圆窝珠作套  
Dapping bead

T.GI.00233 12.5kg  
内腔尺寸 Cavity Size (mm): 2, 3, 4, 5, 6, 7, 8, 9,  
10, 11, 12, 13, 14, 15, 16, 17, 18, 19, 20,  
23, 25, 28, 32, 36



特大窝珠作套装  
Dapping bead

T.GI.1019-12 15kg  
内腔尺寸 Cavity Size (mm): 3, 4, 5, 6, 7, 8, 9,  
10, 11, 12, 13, 14, 15, 17, 19, 21, 23, 25,  
28, 32, 36, 40, 45, 50



特大窝珠作套装  
Dapping bead

T.GI.1019-13 36kg  
内腔尺寸 Cavity Size (mm): 2, 3, 4, 5, 6, 7, 8, 9,  
10, 11, 12, 13, 14, 15, 16, 17, 18, 19, 20, 21, 23, 24,  
25, 28, 30, 32, 35, 40, 45, 50, 60, 70, 80, 90, 100



窝冲24件套  
Dapping bead

T.GI.1019-14 6.8kg  
内腔尺寸 Cavity Size (mm): 3, 4, 5, 6, 7, 8, 9,  
10, 11, 12, 13, 14, 15, 17, 19, 21, 23, 25, 28,  
32, 36, 40, 45, 50



槽窝珠作套装  
Dapping bead

T.GI.1019-15 7kg  
内腔尺寸 Cavity Size (mm): 3, 4, 5, 6, 7, 8, 9,  
10, 12, 14, 16, 18, 20, 25, 30



方窝作24件套  
Dapping bead (24 Pcs)

T.GI.1019-16 16kg  
内腔尺寸 Cavity Size (mm): 3, 4, 5, 6, 7, 8, 9,  
10, 11, 12, 13, 14, 15, 17, 19, 21, 23, 25, 28,  
32, 36, 40, 45, 50



套装窝珠作 (冲头) 29支装  
Dapping block (12 Pcs)

T.GI.00250



套装窝作  
Dapping bead

T.GI.1019-21



套装窝作  
Dapping bead

T.GI.1019-23



套装窝珠作 (冲头) 5支装  
Dapping bead (5 Pcs)

T.CG.00173 3.4kg  
内腔尺寸 Cavity Size (mm): 28, 32, 35, 40, 45



整形套装  
Dapping punches set

T.GI.00244

镶口模具  
Bezel block

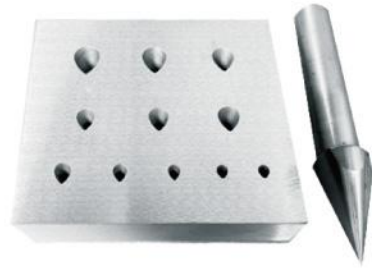

水滴形  
Drop shape  
T.GI.1019-24

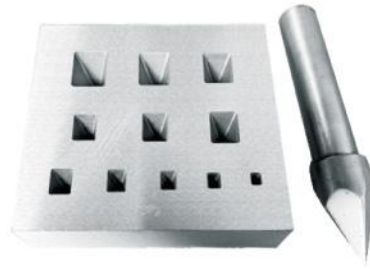

长方形  
Rectangle shape  
T.GI.1019-25

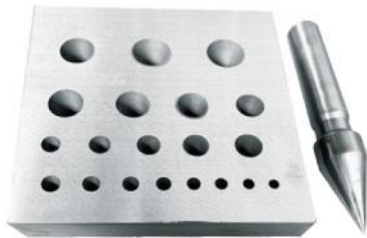

圆形  
Round shape  
T.GI.1019-26



正方形  
Square shape  
T.GI.1019-27



正方形  
Square shape  
T.GI.1019-28



椭圆形  
Oval shape  
T.GI.1019-29

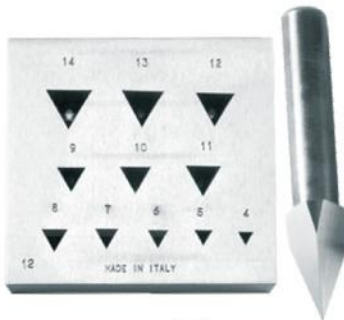

三角形  
Triangle shape  
T.GI.1019-30

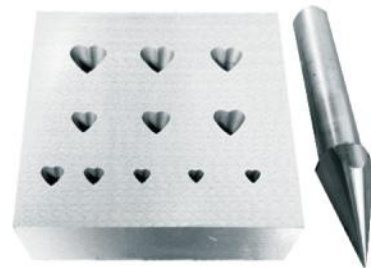

心形  
Heart shape  
T.GI.1019-31



四方铁  
Dappling block

代码 Model	尺寸 Size	重量 Weight	备注 Notes
T.GI.00060	63×63×30mm	0.9kg	
T.GI.00010	75×75×30mm	1.3kg	
T.GI.00062	100×100×30mm	2.3kg	
T.GI.00060-1	60×60×20mm	0.6kg	特硬 Extra hard
T.GI.00010-1	80×80×30mm	1.5kg	特硬 Extra hard
T.GI.00062-2	100×100×20mm	1.6kg	特硬 Extra hard
T.GI.00062-1	100×100×30mm	2.3kg	特硬 Extra hard



英国圆片冲压器  
Durston

T.GI.40001 6KG  
内腔尺寸 Cavity Size (mm): 3, 6, 9, 13, 16, 19, 22, 25, 32



英国圆形冲片器  
Durston

T.GI.00238 6KG  
内腔尺寸 Cavity Size (mm): 4, 5, 6, 7, 8, 9, 10, 11, 12, 13, 14, 15, 16, 17, 18, 19, 20



英国圆片冲孔器 (17支)  
Disc Cutter (17 pcs)

T.GI.00251 3.6KG  
内腔尺寸 Cavity Size (mm): 4, 5, 6, 7, 8, 9, 10, 11, 12, 13, 14, 15, 16, 17, 18, 19, 20



英国圆片冲孔器 (8支)  
Disc Cutter (8 pcs)

T.GI.40003 15.5KG  
内腔尺寸 Cavity Size (mm): 20, 25, 30, 35, 40, 45, 50, 55



圆片冲压器 (5支)  
Disc Cutter with (5 pcs)

T.GI.40004 4.3KG  
Size: 5 5/8" x 5 5/8" x 1 7/16"  
内腔尺寸 Cavity Size: 1", 1 1/4", 1 3/4", 1 1/2", 2"



圆片冲压器 (7支)  
Disc Cutter Set (7 pcs)

T.GI.40005 0.9KG  
Size: 2 1/2" x 2 1/2" x 1"  
内腔尺寸 Cavity Size: 1/4", 5/16", 3/8", 1/2", 9/16", 5/8"



圆片冲压器 (14支)  
Disc Cutter Set (14 pcs)

T.GI.40006  
Size: 4 1/8" x 1 3/4" x 1 1/8" 1.2KG  
内腔尺寸 Cavity Size: 7/64", 11/64", 15/64", 3/16", 17/64", 19/64", 5/16", 21/64", 7/16", 15/32", 1/2", 35/64", 5/8"



圆片冲压器 (14支)  
Disc Cutter Set (14 pcs)

T.GI.40007  
Size: 2 7/8" x 2 7/8" x 1 5/16" 1.2KG  
内腔尺寸 Cavity Size: 1/2", 5/8", 3/4", 7/8", 1"

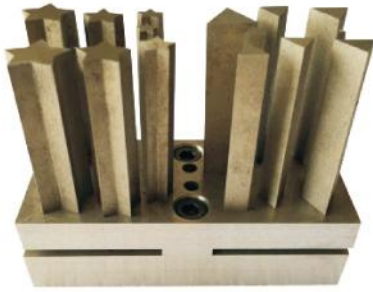

五角星/三角形冲压器 (15支)  
A star / Triangle (15 pcs)

T.GI.40010  
Size: 4 1/8"×1 3/4"×1 1/8" 1.2KG  
内腔尺寸 Cavity Size (mm): 6×6, 7.7×7.7, 9.5×9.5, 11×11, 13×13, 15×15, 17×17



四叶草冲压器 (6支)  
Four leaf clover (6 pcs)

T.GI.40009  
Size: 4 1/8"×1 3/4"×1 1/8" 1.35KG  
内腔尺寸 Cavity Size (mm): 9×9, 12×12, 14×14, 16×16, 18×18, 20×20



长方/正方形冲压器 (11支)  
Rectangular / Square (11 pcs)

T.GI.40008  
Size: 4 1/8"×1 3/4"×1 1/8" 1.35KG  
内腔尺寸 Cavity Size (mm): 5.9×5.9, 9.9×9.9, 10.4×10.4, 11.9×11.9, 12.5×12.5, 4×10, 6×10, 7.3×15.3, 8×16, 9.3×19.3, 10×20

冲片模具  
Punching dies



十字形  
Cross shape  
T.GI.50005



心形  
Heart shape  
T.GI.50006



五角星形  
Pentagram shape  
T.GI.50001



四叶草形  
Four-leaf clover  
T.GI.50002

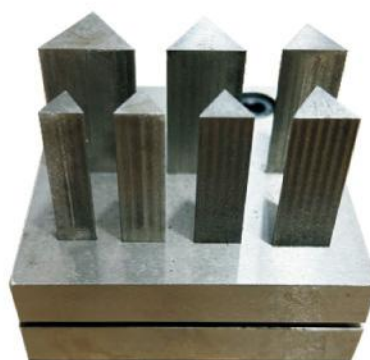

三角形  
Triangle shape  
T.GI.50003



水滴形  
Drop shape  
T.GI.50004



欧式两用小油夹 (圆条/平板)  
Flat Ingot Mould

T.GI.00241  
Diameter:  $\Phi 5$ 、 $\Phi 7$ 、 $\Phi 9$ 、 $\Phi 11$ 、 $\Phi 13$ mm  
Pieces: 6×80mm Weight: 2.5KG



两用小油夹 (圆条/平板)  
Flat Ingot Mould

T.GI.00241-5  
Diameter:  $\Phi 5$ 、 $\Phi 7$ 、 $\Phi 9$ 、 $\Phi 11$ 、 $\Phi 13$ mm  
Pieces: 6×80mm Weight: 2.2KG



两用大油夹 (圆条/平板)  
Flat Ingot Mould

T.GI.00241-2  
Diameter:  $\Phi 4$ 、 $\Phi 6$ 、 $\Phi 8$ 、 $\Phi 10$ 、 $\Phi 12$ mm  
Pieces: 8×12mm Weight: 3.8KG

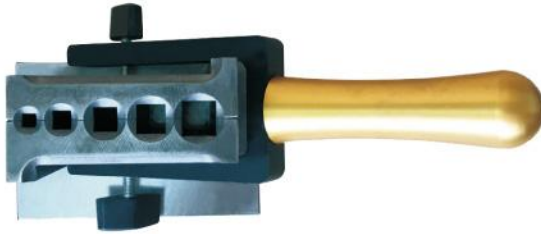

小两用小油夹 (方条/薄片)  
Small ingot mould

T.GI.00241-9  
Diameter: 5×5、7×7、9×9、11×11、13×13mm  
Pieces: 6×80mm Weight: 2.2KG

油槽  
Steel trough



六坑油槽  
Steel trough with six holes  
T.RC.RR020



八坑油槽  
Steel trough with eight holes  
T.RC.RR021



4寸油槽  
4" Steel trough  
T.RC.RR022



7寸油槽  
7" Steel trough  
T.RC.RR027



8寸油槽  
8" Steel trough  
T.RC.RR035



大弧度四方墩  
Big square pier  
T.GI.1019-18  
170×70×70mm 3KG



小弧度四方墩  
Small square pier  
T.GI.1019-19  
170×70×70mm 3KG



台面定位铁  
All sizes locating iron  
T.GI.1021-2 1.5KG



配件定位铁  
Fitting locating iron  
T.GI.1021-3



牛角站  
Horn anvil  
T.GI.00009  
76×102×100mm



微型牛角站  
Mini horn anvil  
T.GI.00009-1  
118×65×20mm 0.5kg



重型牛角站  
Heavy horn anvil  
Model: T.GI.00009-2  
240×130×70mm 5kg



四方墩  
Square pier  
T.GI.00009-3  
200×70×70mm 3KG



吸珠针套装  
Beading Tools SET  
T.SL.00001



吸珠针  
Beading Tools  
T.SL.X0000~22  
0#~22#



万能镶石座承铁  
Iron holder for engraver's block  
T.GI.1023-2  
2.4KG



台塞套装  
Taisai set  
T.CG.00227



火漆  
Sealing wax  
T.GI.00015 12 Pcs/Box



火漆球 (小、中、大)  
Sealing wax ball with base (small, medium, large)  
2" T.GI.00005, 4" T.GI.00016, 6" T.GI.00037



黑橡胶微镶球底座  
Rubber base  
Model: T.GI.00110



万能手柄  
Universal handle  
T.SB.00006



冬菇素咀  
Moushroom shape nozzle  
T.GI.00042



葫芦素咀  
STK steel nozzle  
T.GI.00030



双头素咀  
Double heads steel bur  
T.GI.00029



3寸圆规机剪  
3" Compass divider  
T.GI.00059



5寸圆规机剪  
5" Compass divider  
T.GI.00059-1



6寸圆规机剪  
6" Compass divider  
T.GI.00059-2



宝石爪 (3爪)  
Gem holder  
T.GI.00063



火枪底座  
Torch holder  
T.GI.1019-20



马头木  
Matou wood  
T.CG.00064 180×35×12mm



坑木  
Timber  
T.CG.00001-C



戒指木夹  
Wooden Ring Clamp  
型号 Model: T.GI.00061



夹式LED台灯  
Clip table lamp  
M.MS.WXPJ40



钻石台灯  
Diamond table lamp  
M.MS.WXPJ23



绿台灯  
Green desk lamp  
M.MS.WXPJ26



LED灯  
LED lamp  
M.MS.WXPJ18



可调LED灯  
Adjustable LED lamp  
M.MS.WXPJ18-C



LED灯  
LED lamp  
M.MS.WXPJ32



LED灯  
LED lamp  
M.MS.WXPJ34



LED环形灯  
LED circular lamp  
M.MS.WXPJ35



144顆金属灯头LED灯  
144 metal lamp heads LED lights  
M.MS.WXPJ35-B



三色LED环形灯  
Tri color LED circular lamp  
M.MS.WXPJ36

放大镜台灯  
Magnifying mirror desk lamp



M.MS.WXPJ21



M.MS.WXPJ33



M.MS.WXPJ37



M.MS.WXPJ38



M.MS.WXPJ39



M.MS.WXPJ41

折叠台灯  
Folding desk lamp



颜色: 黑色 / 白色 / 红色 / 黄色 / 金色 / 银色 / 粉红色  
Color: Black / White / Red / Yellow / Gold / Silver / Pink  
M.MS.WXPJ20



颜色: 黑色 / 白色 / 蓝色 / 红色  
Color: Black / White / Blue / Red  
M.MS.WXPJ20-B

手镯切割机  
Rotary tumblers



型号 Model: M.MF.Q0040  
切片尺寸 Slice size:  $\Phi$ 8cm  
功率 Power: 220V/370W/2.45A  
置物台 Shelf: 平面 Flat / 曲面 curved  
转速 Speed: 可变速 Variable speed  
尺寸 Size: 390x200x350mm  
重量 Weight: 15.5kg

用途: 切割金、银条、手镯等  
Usage: Cutting gold and silver bars/bracelets, etc.

手镯切管机  
Rotary Tumblers



型号 Model: M.MF.Q0041  
方便快捷 Convenience: 快速切割 Fast cutting  
功率 Power: 220V/370W/2.45A  
置物台 Shelf: 平面 Flat  
转速 Speed: 4000rpm  
尺寸 Size: 420x265x310mm  
重量 Weight: 13.45kg

用途: 切割金、银条等  
Usage: Cutting gold and silver bars/bracelets, etc.

珍珠钻孔机  
Pearl Drilling Machine

电压 Voltage: 220V/50  
马达 Motor: 6000rpm  
可钻最大直径 35mm的珍珠  
Can hold big pearls upto 35mm

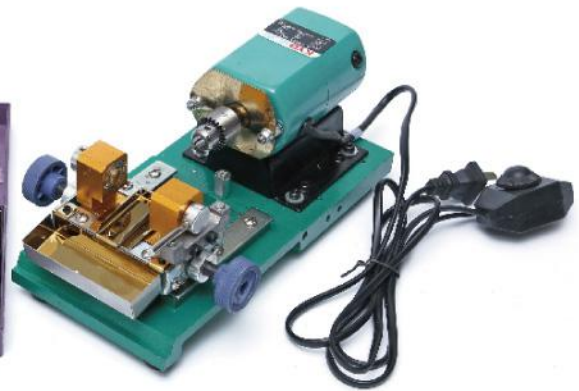

全套包括 Complete with  
5个珍珠素咀 5 pearl chucks:  $\Phi$ 3,  $\Phi$ 5,  $\Phi$ 7,  $\Phi$ 9,  $\Phi$ 11mm

T.GI.00112-A



T.GI.00112



T.GI.00112-B



T.GI.00112-C



**30A点焊机**  
**30A Spot Welder**  
型号 Model: M.SW.00003  
电压 Voltage: 110V/220V  
尺寸 Size: 270x165x135mm  
重量 Weight: 5kg



**60A点焊机**  
**60A Spot Welder**  
型号 Model: M.SW.00009  
电压 Voltage: 110V/220V  
尺寸 Size: 300x220x750mm  
重量 Weight: 6kg



**80A高频精密点焊机**  
**80A High-Frequency Precision Spot Welder**  
型号 Model: M.SW.00009  
电压 Voltage: 110V/220V  
尺寸 Size: 300x220x750mm  
重量 Weight: 6kg



**90A高频精密点焊机**  
**90A High-Frequency Precision Spot Welder**  
型号 Model: M.SW.00026  
电压 Voltage: 110V/220V  
尺寸 Size: 300x220x750mm  
重量 Weight: 6kg



**100A变频脉冲焊金机**  
**100A Variable-Frequency Pulse Gold Welding Machine**  
型号 Model: M.SW.00008  
电压 Voltage: 110V/220V  
尺寸 Size: 300x220x750mm  
重量 Weight: 6kg



**150A多功能自动首饰焊机**  
**150A Multi-function Auto Jewelry Welder**  
型号 Model: M.SW.00024  
电压 Voltage: 110V/220V  
尺寸 Size: 300x220x150mm  
重量 Weight: 7kg



**150A多功能自动首饰焊机(配护眼镜)**  
**150A Multi-function Auto Jewelry Welder (with protective goggles)**  
型号 Model: M.SW.00024-B  
电压 Voltage: 110V/220V  
尺寸 Size: 300x220x150mm  
重量 Weight: 9kg



**200A护眼多功能自动首饰焊机**  
**200A Eye-Protected Multi-function Automatic Jewelry Welder**  
型号 Model: M.SW.00024-B  
电压 Voltage: 110V/220V  
尺寸 Size: 300x220x150mm  
重量 Weight: 9kg



**100A自动式点焊机**  
**100A Automatic Spot Welder**  
型号 Model: M.SW.00023  
电压 Voltage: 220V/50hz  
焊接电压 Solder Voltage: 40V  
焊接电流 Solder current: 5A-600A  
焊接时间 Solder time: 3ms-30ms

**触屏碰焊机**  
**Touch Screen Spot Welder**  
电压 Voltage: 110V/220V, 50/60HZ  
功率 Power: 150W  
功率保险 Power insurance: 5A  
输入功率 Input power: 500VA  
工作电压 Working voltage: DC 30-40V  
焊点直径 Solder joint diameter: 0.1-5mm  
保护气体 Protective gas: 氩气 Argon



M.SW.150Ws-A



M.SW.150Ws-B



美国氧气小火枪  
USA torch for oxygen

氧气枪配合氧气和丁烷(液化气)使用, 每1个枪头的大小不一样, 可根据不同的产品, 配置不同的枪头使用最高焊接温度可达1700°C, 适合熔铸焊接各种精密产品, 如黄金、银、K金、铂金、钯金、铜、铅锡合金及一些工艺品焊接等。

The oxygen gun is used in conjunction with oxygen and butane (liquefied gas), and each gun head has a different size. Different gun heads can be configured according to different products. The highest welding temperature can reach 1700 °C, making it suitable for melting and welding various precision products, such as gold, silver, K-gold, platinum, palladium, copper, lead-tin alloys, and some handicraft welding.

枪头Tips: 3#, 4#, 5#, 6#, 7#

T.TO.A0006



台湾氧气枪五个焊咀  
Taiwan Torch for oxygen with 5 tips

T.TO.T0005

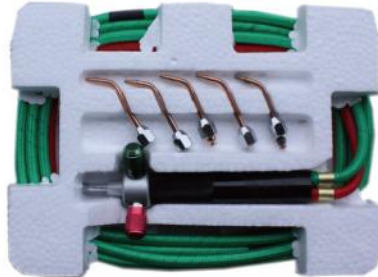

美国氧气枪  
Taiwan Torch made in USA

T.TO.A0005



台湾氧气枪一个焊咀  
Taiwan Torch for oxygen with 1 tip

T.TO.T0001



H01-20焊枪  
H01-20 torch for oxygen

T.TO.H0120



300型焊枪  
300 torch for oxygen

T.TO.00300-R



150E型割枪 (乙炔专用)  
150E torch for oxygen

T.TO.0150E-A



150E型割枪 (丙烷专用)  
150E torch for oxygen

T.TO.0150E-B



1006白单喉吹  
Single tube small oil pot

T.TO.01006



铜加大单喉吹  
Single tube small oil pot

T.TO.00004



铜加大大喉吹  
Single tube small oil pot

T.TO.00028

喉吹  
Welding torch lighter

配全熔焊机或者风球等设备使用，可以熔化金、银、铜等及焊接各种材料工艺品。

Equipped with full fusion welding machines or wind turbines, it can melt gold, silver, copper, and weld various materials and handicrafts.

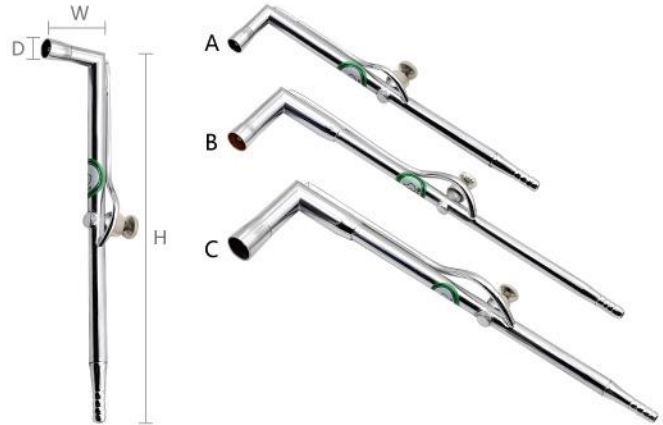

代码 Model	D	W	H	重量 Weight
A T.TO.00002	Φ12mm	39mm	206mm	75g
B T.TO.00001	Φ16mm	51mm	258mm	105g
C T.TO.00003	Φ20mm	69mm	285mm	155g



单管小油壶  
Single tube small oil pot  
T.BK.00001



单管大油壶  
Single tube large oil pot  
T.BK.00002



双管小油壶  
Double tube small oil pot  
T.BK.00004



双管大油壶  
Double tube large oil pot  
T.BK.00004

多方位电子点火器  
Electrical torch lighter

尺寸 Size: 75×75×50mm  
重量 Weight: 338g



T.TO.00005



T.TO.00005-2

单方位电子点火器  
Electrical torch lighter

尺寸 Size: 90×50×70mm  
重量 Weight: 209g

T.TO.00009



只需将火吹咀轻放在点火器上便能将火点燃，适用于熔焊机，皮老虎打火使用。

Simply place the fire nozzle lightly on the igniter to ignite the fire, suitable for welding machines and leather tiger ignition.



进口银焊粉  
Imported silver welding powder  
T.GI.00072



银焊粉  
Silver welding powder  
T.GI.00084



高磷铜焊粉  
High phosphorus copper welding powder  
T.GI.00133  
60#~200#



高磷铜焊粉  
High phosphorus copper welding powder  
T.GI.00133-2  
150#~300#



25%银焊粉  
25% Silver welding powder  
T.GI.00176



30%银焊粉  
30% Silver welding powder  
T.GI.00177



进口黑焊粉  
Imported black welding powder  
T.GI.00231



进口铜焊粉  
Imported copper welding powder  
T.GI.HF001



风球  
Leather air bellow  
T.AB.P0003



风球套装  
Leather air bellow kit  
T.AB.A0002

用于金银首饰、DIY加工、焊接、融化金银铜等金属使用。  
Used for gold and silver jewelry, DIY processing, welding, melting gold, silver, copper and other metals.

气体打火机  
Gas torch

火焰大小可调节，带有锁火功能，可变换直冲或明火，反复充气使用。

The flame size can be adjusted, with a flame locking function, which can be changed to direct or open flames, and can be repeatedly inflated for use.



T.TO.00040 T.TO.00041 T.TO.00042 T.TO.00048 T.TO.GB2001 T.TO.GT3000 T.TO.GT400S T.TO.GT5000 T.TO.BH501

代码 Model	气体 Gas	容量 Capacity	尺寸 Size	重量 Weight
T.TO.00040	丁烷 Butane	10g	100×60×140mm	177g
T.TO.00041	丁烷 Butane	10g	120×45×172mm	139g
T.TO.00042	丁烷 Butane	10g	120×60×157mm	206g
T.TO.00048	丁烷 Butane	8g	76×60×150mm	142g
T.TO.GB2001	丁烷 Butane	19g	85×65×145mm	235g
T.TO.GT3000	丁烷 Butane	20g	75×62×155mm	275g
T.TO.GT400S	丁烷 Butane	/	138×85×170mm	/
T.TO.GT5000	丁烷 Butane	20g	130×75×185mm	385g
T.TO.BH501	丁烷 Butane	/	130×66×165mm	242g



## 吸尘机 Industrial vacuum cleaner

适用于激光打标、喷码、小型雕刻切割、焊锡、浸锡、锡炉、激光焊等工作环境。  
Applicable to laser marking, inkjet printing, small size engraving and cutting, soldering, tinning, tin furnace, laser welding and other fields



型号 Model: M.SW.PD018  
电压 Voltage: AC220V 50Hz  
功率 Power: 100W  
风量 Air volume: 225m<sup>3</sup>/h  
进风口法兰 Air inlet flange:  $\Phi$ 50mm  
尺寸 Size: 290x245x325mm  
重量 Weight: 8KG



型号 Model: M.SW.PD104  
电压 Voltage: AC220V 50Hz  
功率 Power: 200W  
风量 Air volume: 300m<sup>3</sup>/h  
进风口法兰 Air inlet flange:  $\Phi$ 50mm  
尺寸 Size: 290x245x325mm  
重量 Weight: 10KG



型号 Model: M.SW.PD103  
电压 Voltage: AC220V 50Hz  
功率 Power: 220W  
风量 Air volume: 325m<sup>3</sup>/h  
进风口法兰 Air inlet flange:  $\Phi$ 75mm  
尺寸 Size: 410x240x410mm  
重量 Weight: 17KG



型号 Model: M.SW.PD105  
电压 Voltage: AC220V 50Hz  
功率 Power: 120W  
风量 Air volume: 250m<sup>3</sup>/h  
进风口法兰 Air inlet flange:  $\Phi$ 75mm  
尺寸 Size: 410x240x410mm  
重量 Weight: 15KG



型号 Model: M.SW.PD106  
电压 Voltage: AC220V 50Hz  
功率 Power: 100W  
风量 Air volume: 260m<sup>3</sup>/h  
进风口法兰 Air inlet flange:  $\Phi$ 75mm  
尺寸 Size: 420x245x450mm  
重量 Weight: 17KG



型号 Model: M.SW.PD107  
电压 Voltage: AC220V 50Hz  
功率 Power: 200W  
风量 Air volume: 350m<sup>3</sup>/h  
进风口法兰 Air inlet flange:  $\Phi$ 75mm  
尺寸 Size: 420x295x380mm  
重量 Weight: 15KG



型号 Model: M.SW.PD108  
电压 Voltage: AC220V 50Hz  
功率 Power: 150W  
风量 Air volume: 300m<sup>3</sup>/h  
进风口法兰 Air inlet flange:  $\Phi$ 75mm  
尺寸 Size: 420x245x480mm  
重量 Weight: 18KG



型号 Model: M.SW.PD109  
电压 Voltage: AC220V 50Hz  
功率 Power: 200W  
风量 Air volume: 350m<sup>3</sup>/h  
进风口法兰 Air inlet flange:  $\Phi$ 75mm  
尺寸 Size: 420x295x380mm  
重量 Weight: 15KG



型号 Model: M.SW.PD110  
电压 Voltage: AC220V 50Hz  
功率 Power: 400W  
风量 Air volume: 500m<sup>3</sup>/h  
进风口法兰 Air inlet flange:  $\Phi$ 75mm  
尺寸 Size: 420x320x580mm  
重量 Weight: 25KG

银焊枝  
Silver welding branch

代码 Model	名称 Designation	尺寸 Size
T.CG.00121	35%银焊枝	Φ1.0mm
T.CG.00122	40%银焊枝	Φ0.6mm
T.CG.00123	15%银焊枝	Φ1.0mm
T.CG.00143	30%银焊枝	Φ0.6mm
T.CG.00192	15%银焊枝	Φ1.5mm
T.CG.00198	30%银焊枝	Φ1.0mm
T.CG.00212	40%银焊枝	Φ0.4mm
T.CG.00215	60%银焊枝	Φ0.4mm
T.CG.00216	30%银焊枝	Φ1.5mm
T.CG.00217	25%银焊枝	Φ1.6mm



银焊片  
Silver solder joint

代码 Model	名称 Designation	尺寸 Size
A.CW.00013-B	60%银焊片	35.8×19.05×0.3mm
A.CW.00013-C	30%银焊片	35.8×19.05×0.3mm
A.CW.00011-H	高温银焊片	40×19×0.5mm
A.CW.00011-Z	中温银焊片	40×19×0.5mm
A.CW.00011-D	低温银焊片	40×19×0.5mm



铜焊条  
Copper welding branch

A.CW.00001 Φ0.6mm	A.CW.00003 Φ0.8mm	A.CW.00004 Φ0.3mm	A.CW.00005 Φ0.4mm	A.CW.00006 Φ0.5mm
----------------------	----------------------	----------------------	----------------------	----------------------



铜线  
Copper wire

A.CW.00050 Φ0.3mm	A.CW.00044 Φ0.5mm	A.CW.00032 Φ0.6mm	A.CW.00015 Φ0.7mm	A.CW.00037 Φ0.8mm
A.CW.00014 Φ0.9mm	A.CW.00046 Φ1.0mm	A.CW.00016 Φ1.2mm	A.CW.00022 Φ1.5mm	A.CW.00033 Φ1.7mm
A.CW.00045 Φ1.8mm	A.CW.00018 Φ2.0mm	A.CW.00021 Φ2.5mm	A.CW.00017 Φ3.0mm	



石英烧杯  
Ceramic beaker



代码 Model	直径 Diameter	高度 Height
C.CA.03000-B	Φ170mm	350mm
C.CA.03000-C	Φ160mm	-
C.CA.03000-D	Φ171mm	350mm
C.CA.05000	Φ180mm	280mm
C.CA.0800	Φ205mm	300mm
C.CA.170230	Φ250mm	160mm
C.CA.250160	Φ250mm	160mm
C.CA.280160	Φ280mm	160mm
C.CA.300025	Φ300mm	250mm



石英篮  
Ceramic basket

代码 Model	直径 Diameter	高度 Height
C.CA.00002-B	Φ180mm	310mm
C.CA.00002-C	Φ150mm	310mm
C.CA.00005	Φ140mm	330mm



石英板  
Ceramic board  
C.CA.300300012  
300×300×12mm

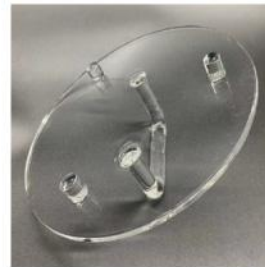

石英烧杯盖子  
Ceramic beaker cover

代码 Model	直径 Diameter	高度 Height
C.CA.00003	Φ210mm	5mm
C.CA.00004	Φ190mm	5mm
C.CA.00006	Φ180mm	5mm
C.CA.00008	Φ200mm	5mm

洗货挂勾  
Hanging hook



代码 Model	层 Layer
M.UC.P0016	2
M.UC.P0017	3
M.UC.P0032	4
M.UC.P0032-B	4



代码 Model	层 Layer
M.UC.P0016-B	2
M.UC.P0017-B	3
M.UC.P0032-C	4

过滤纸  
Filter paper

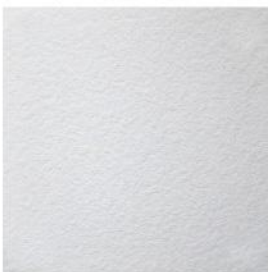

T.GI.00021  
60×60cm 厚 Thick



T.GI.00194  
60×60cm 薄 Thin



T.GI.00051  
Φ12.5mm



T.GI.00052  
Φ18mm



塑料钛篮 (吊酸篮)  
Plastic titanium basket (Acid hanging basket)

- 1000ML T.AB.B0035
- 2000ML T.AB.B0036
- 3000ML T.AB.B0032
- 5000ML T.AB.B0034



钛篮 (吊酸篮)  
Titanium basket (Acid hanging basket)

- 1000ML T.AB.B0037
- 2000ML T.AB.B0038
- 3000ML T.AB.B0039
- 5000ML T.AB.B0022



钛金数控小吊酸炉  
Titanium CNC small hanging acid furnace



水线  
Waterline

- Φ0.2mm T.GI.00086-2
- Φ0.3mm T.GI.00086
- Φ0.35mm T.GI.00087
- Φ0.45mm T.GI.00197
- Φ0.6mm T.GI.00160
- Φ1mm T.GI.00197-B

铂金钛网  
Platinum titanium mesh

常用于电解和电镀，不容易溶解，不容易变色，有良好的导电作用。

- 1、钛网配合电镀机和电解水使用，在金银铜饰品表面有效的进行清洗活化，对工件表面起到清洁的作用。
- 2、钛网配合电镀机和电镀水使用，在金银铜饰品表面镀上一层白金或黄金，起到保护饰品防止氧化。

Commonly used in electrolysis and electroplating, it is not easily dissolved, not easily discolored, and has good conductivity.

1. Titanium mesh is used in conjunction with electroplating machines and electrolytic water to effectively clean and activate the surface of gold, silver, and copper jewelry, providing a cleaning effect on the surface of the workpiece.
2. Titanium mesh is used in conjunction with electroplating machines and electroplating water to coat the surface of gold, silver, and copper jewelry with a layer of platinum or gold, which protects the jewelry from oxidation.



- T.AB.B0016 50×110mm
- T.AB.B0016-B 50×110mm (带柄 With handle)
- T.AB.B0017 60×150mm
- T.AB.B0017-B 60×150mm (带柄 With handle)
- T.AB.B0002 50×210mm
- T.AB.B0040 25×50mm
- T.AB.B0041 35×80mm
- T.AB.B0042 90×150mm



30安电金机  
30A plating machine  
M.RH.0030A



30安电金机  
30A plating machine  
M.RH.0030A-b



20/30安脉冲电金机  
20/30A pulse plating machine  
M.RH.0020B / M.RH.0030B



数显电金机  
Digital plating machine

M.RH.00001  
电源 Power supply: 220V  
输出 Output: 30V/20A



数显电金机  
Digital plating machine

M.RH.00002  
电源 Power supply: 220V  
输出 Output: 15V/5A



数显电金机  
Digital plating machine

M.RH.00003  
电源 Power supply: 220V  
输出 Output: 30V/5A



数显电金机  
Digital plating machine

M.RH.00004  
电源 Power supply: 220V  
输出 Output: 30V/5A



笔用电金机  
Pen plating machine

M.RH.B0001  
电源 Power supply: 220V  
输出 Output: 12V/5A



A款笔式电镀机  
A Pen plating machine

M.RH.B0004  
电源 Power supply: 220V  
输出 Output: 12V/2A



D款笔式电镀机  
D Pen plating machine

M.RH.B0005  
电源 Power supply: 220V  
输出 Output: 12V/2A



笔用电金机  
Pen plating machine

型号 Model	M.RH.B0002
输入电压 Input voltage	115-230V/50-60HZ
最大耗电量 Maximum power consumption	65VA
最大输出电压 Maximum output voltage	2-13V
最大输出电流 Maximum output current	3A
尺寸 Size	170x160x130mm
重量 Weight	700g



电镀笔喷嘴  
Nozzle for plating pen

代码 Model	直径 Diameter	高度 Height
M.RH.P0002	Φ3.5mm	25mm
M.RH.P0003	Φ3mm	46mm
M.RH.P0004	Φ3.5mm	20mm
M.RH.P0005	Φ3.5mm	22.5mm
M.RH.P0006-1	Φ3.5mm	24mm
M.RH.P0006-2	Φ3.5mm	24mm
M.RH.P0006-3	Φ3.5mm	25mm



A-塑料量杯  
Measuring cup

代码 Model	宽度 Width	高度 Height	容量 Capacity	包装 Package
H.BK.C0004	65mm	96mm	250ml	500 Pcs/Box
H.BK.C0005	65mm	96mm	300ml	500 Pcs/Box
H.BK.C0006	88mm	114mm	500ml	200 Pcs/Box
H.BK.B0007	98mm	143mm	1000ml	150 Pcs/Box
H.BK.C0001	116mm	203mm	2000ml	100 Pcs/Box
H.BK.C0003	139mm	217mm	3000ml	60 Pcs/Box
H.BK.C0002	163mm	261mm	5000ml	30 Pcs/Box



B-塑料量杯  
Measuring cup

代码 Model	宽度 Width	高度 Height	容量 Capacity	包装 Package
H.BK.B0004	34mm	39mm	25ml	3000 Pcs/Box
H.BK.B0002	42mm	62mm	50ml	2000 Pcs/Box
H.BK.B0003	49mm	68mm	100ml	1000 Pcs/Box
H.BK.B0011	58mm	78mm	150ml	1000 Pcs/Box
H.BK.B0012	62mm	85mm	200ml	500 Pcs/Box
H.BK.B0013	69mm	95mm	250ml	500 Pcs/Box
H.BK.B0014	69mm	95mm	300ml	500 Pcs/Box
H.BK.B0015	90mm	114mm	500ml	300 Pcs/Box
H.BK.B0016	104mm	140mm	1000ml	200 Pcs/Box



C-塑料量杯  
Measuring cup

代码 Model	宽度 Width	高度 Height	容量 Capacity	包装 Package
H.BK.D0001	31mm	22mm	10ml	10000 Pcs/Box
H.BK.D0002	32mm	28mm	15ml	8000 Pcs/Box
H.BK.D0003	32mm	32mm	20ml	7500 Pcs/Box
H.BK.D0004	32mm	36mm	30ml	5000 Pcs/Box
H.BK.D0005	33mm	57mm	50ml	5000 Pcs/Box
H.BK.D0006	42mm	49mm	60ml	3500 Pcs/Box
H.BK.D0007	47mm	62mm	100ml	2500 Pcs/Box
H.BK.D0008	56mm	69mm	200ml	1600 Pcs/Box

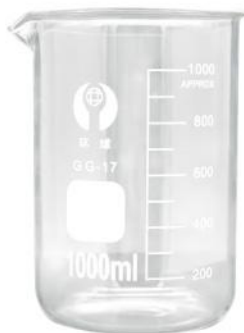

玻璃量杯  
Glass measuring cup

代码 Model	容量 Capacity	包装 Package
H.BK.A0005	250ml	10 Pcs/Box
H.BK.A0006	5000ml	8 Pcs/Box
H.BK.A0007	1000ml	6 Pcs/Box
H.BK.A0008	2000ml	6 Pcs/Box
H.BK.A0004	3000ml	8 Pcs/Box
H.BK.A0003	5000ml	6 Pcs/Box

**EP300电解抛光机**  
**EP300 ELECTRIC POLISHING MACHINE**

适合于金、银、铜、不锈钢材质小件的精密抛光。在隙位、细孔、内凹等部位上发挥出重要作用，抛光不需要任何磨料，完全借助电解作用。电解基本原则高电平去毛刺，中电平整平，低电平出光，分段程序控制。

电解过程安全可靠，电解液不含铬酐、氰化物等有毒有害物质，绿色环保，不燃烧，不爆炸，尾液处理容易。

Suitable for precision polishing of small pieces made of gold, silver, copper, and stainless steel materials. Plays an important role in areas such as gaps, pores, and indentations, polishing does not require any abrasives and relies entirely on electrolysis. The basic principles of electrolysis include deburring at high levels, leveling at medium levels, emitting light at low levels, and segmented program control.

The electrolysis process is safe and reliable, and the electrolyte does not contain toxic and harmful substances such as chromic anhydride and cyanide. It is environmentally friendly, non combustible, non explosive, and easy to handle the tail liquid.

**产品特点 PRODUCT FEATURES**



**循环过滤 CIRCULATING FILTRATION**

带有循环过滤系统，提高电解抛光质量。  
Equipped with a circulating filtration system to improve the quality of electrolytic polishing.



**恒温功能 CONSTANT TEMPERATURE FUNCTION**

配备冷暖双控温冷水机，提高电解抛光效率。  
Equipped with a dual temperature controlled chiller to improve the efficiency of electrolytic polishing.



**回收处理 RECYCLING PROCESSING**

一键自动回收，解除回收难的问题。  
One click automatic recycling, eliminating the problem of difficult recycling.



抛光前 Before polishing



抛光后 After polishing

型号 Model	电源 Power supply	功率 Power	最大电流输出 Maximum current output	尺寸 Size
Z.M.MT.EP300D	单相 Single-phase AC220V, 50 / 60Hz	2.2KW	DC20V, 100A	700×950×1100mm

抛光工件数量：5个挂篮，单个放置4~8件工件  
Quantity of polished workpieces: 5 hanging baskets, each holding 4-8 workpieces

**SP2000磁力抛光机**  
**SP2000 Magnetic polishing machine**

应用于首饰铸件表面处理，适用于金、银、铜等合金及其它非磁性材质的抛光，适用于小金表面去毛刺、去披锋等。

Application scenarios: treatment for the surface of jewelry castings; polishing of alloys like gold, silver and copper alloys and other non-magnetic materials; eliminating burrs on the surface of metals etc.

型号 Model	M.MT.SP2000
电源 Voltage	AC220V 50-60Hz
功率 Power	370W
抛光量 Polishing amount	2000g
抛光桶尺寸 Polishing chamber size	370×260×200mm
尺寸 Size	428×428×585mm
净重 Neight weight	24.5Kg



## 磁力抛光机系列 Magnetic tumbler series



### 产品特点

本机适用于金、银、铜、锌合金及其他不导磁材料的抛光，去毛刺、去披锋等。

- 1、大功率马达，交替式磁场设计，动力更强劲；
- 2、数字式电路，可自由设定正反转时间继电器；
- 3、电气控制部分，选用进口配件，机器寿命更长；
- 4、设计精巧，操作方便；
- 5、搬离抛光桶后自动停机，节能环保。

### Product Features

Apply to jewelry surface processing, suitable for the polishing of gold/silver/copper/zinc-alloy and other metals without magnetic. Suitable to make the surface of hardware to be smooth without burrs.

1. Big power motor and alternate magnetic field to machine make it more powerful.
2. With digital circuit, reversible time can be set any time.
3. Electrical parts are made by imported material to extend the life of machine.
4. Elaborate design and convenient operation.
5. When polishing chamber is took out of machine, tumbler will stop automatically to save power.



抛光前  
Before polishing



抛光后  
After polishing



中式插头  
China plug

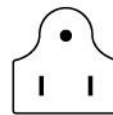

美式插头  
USA plug

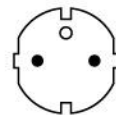

欧式插头  
Europe plug



澳式插头  
Australia plug

型号 Model	M.MT.P0800	M.MT.P1000	M.MT.P1500	M.MT.P2500
额定功率 Rated power	250W	550W	750W	1100W
额定电压 Rated voltage	110V, 60Hz / 220V, 50Hz	110V, 60Hz / 220V, 50Hz	110V, 60Hz / 220V, 50Hz	220V, 50Hz
电机转速 Motor speed	2800 rpm/min	2800 rpm/min	2800 rpm/min	1400 rpm/min
抛光量 Polishing amount	800g	1000g	1500g	2500g
抛光桶尺寸 Polishing chamber size	Φ165×H140mm	Φ210×H150mm	Φ290×H160mm	Φ330×H175mm
外形尺寸 Outline size	260×250×310mm	290×290×340mm	360×400×370mm	450×420×603mm
包装尺寸 Package size	360×290×480mm	390×330×520mm	470×450×580mm	530×495×645mm
机器毛重 G.W	18kg	22kg	28kg	42kg
机器净重 N.W	16kg	20kg	23.5kg	40kg

变频调速磁力抛光机  
Frequency conversion magnetic polishing machine



M.MT.B0260



M.MT.B0360



M.MT.B0360-A



M.MT.P0460

型号 Model	M.MT.B0260	M.MT.B0360	M.MT.B0360-A	M.MT.P0460
电压 Voltage	220V	220V	220V	220V/380V
功率 Power	750W	1500W	1500W	2200W
电机转速 Motor speed	1800 rpm/min	1800 rpm/min	1800 rpm/min	1800 rpm/min
钢针用量 Steel needle quantity	0-800G	0-1000G	0-1000G	0-2000G
抛光量 Polishing amount	0.5-2.5KG	0.5-5KG	0.5-5KG	0.5-10KG
外形尺寸 Outline size	330x330x380mm	410x410x430mm	410x410x430mm	520x520x680mm
重量 Weight	28KG	38KG	38KG	80KG



M.MT.B0420



M.MT.B0520



M.MT.B0620

型号 Model	M.MT.B0420	M.MT.B0520	M.MT.B0620
电压 Voltage	220V/380V	380V	380V
功率 Power	1500W	2200W	4000W
电机转速 Motor speed	1800 rpm/min	1800 rpm/min	1800 rpm/min
钢针用量 Steel needle quantity	0-1500G	0-3000G	0-4000G
抛光量 Polishing amount	0.5-8KG	0.5-12KG	0.5-15KG
外形尺寸 Outline size	650x510x1030mm	600x760x1030mm	730x930x1130mm
重量 Weight	63KG	100KG	150KG



M.MT.B0260-B

M.MT.B0360-B

**强磁研磨抛光机**  
Strong magnetic polishing machine

型号 Model	M.MT.B0260-B	M.MT.B0360-B
电压 Voltage	220V	220V
功率 Power	550W	750W
电机转速 Motor speed	1400 rpm/min	1400 rpm/min
钢针用量 Steel needle quantity	0-600G	0-800G
抛光量 Polishing amount	0.5-2KG	0.5-3KG
外形尺寸 Outline size	330x330x380mm	410x410x430mm
重量 Weight	33KG	40KG



**平移式磁力研磨机**  
Translational Magnetic Polishing Machine

适用于金属等多种材质工件的表面抛光、去毛刺、倒角等处理。本设备配备自动倒料、自动反转、变频调速及触摸屏控制系统，操作简便、抛光效率高、效果均匀。

Suitable for surface polishing, deburring, and chamfering of workpieces made of various materials, including metals. This equipment features automatic material feeding, automatic reversal, variable frequency speed control, and a touchscreen control system, offering easy operation, high polishing efficiency, and uniform results.

型号 Model	M.MT.Q890
电压 Voltage	380V/3PH/50Hz
功率 Power	4KW
加工重量 Processing weight	1-15KG
研磨槽尺寸 Grinding tank dimensions	900x600mm
机器尺寸 Machine Size	1280x750x1250mm
重量 Weight	500kg



M.MT.B360BP

**平移式变频调速磁力抛光机**  
Strong magnetic polishing machine

**产品特点:**

- 1、抛大件长条均匀度高，包括亮度和沙面、去毛刺均匀度极高。
- 2、平移抛光机在原有的圆形基础上，因为左右来回移动，大大增加了磁场面积的长度，适合抛较长的产品。(较适合抛管类、块状的产品。如：笔记本电脑底壳)。
- 3、平移设备可配合隔板处理盆状或怕磕碰的产品分隔批量处理。

**Product Features:**

1. The uniformity of throwing large pieces is high, including high brightness and sand surface, as well as extremely high uniformity of deburring.
2. The translation polishing machine, on the basis of the original circular shape, greatly increases the length of the magnetic field area due to its left and right back and forth movement, making it suitable for polishing longer products. (More suitable for products in the form of throwing tubes and blocks, such as laptop bottoms)
3. The translation device can be used in conjunction with partitions to handle batch processing of basin shaped or collision resistant products.



M.MT.B1050





M.MT.BJ1200



M.MT.BJ1800

型号 Model	M.MT.B360BP	M.MT.B1050	M.MT.BJ1200	M.MT.BJ1800
电压 Voltage	220V	380V	380V	380V
功率 Power	1.5KW	2.5KW	4.3KW	8.3KW
电机转速 Motor speed	2000 rpm/min	1800 rpm/min	1800 rpm/min	1800 rpm/min
钢针用量 Steel needle quantity	0-2KG	5-15KG	10-20KG	10-20KG
抛光量 Polishing amount	10KG	20KG	30KG	60KG
外形尺寸 Outline size	780x640x970mm	1200x660x680mm	1350x760x680mm	1980x760x680mm
重量 Weight	115KG	190KG	225KG	360KG



M.MT.BO280-A



M.MT.BSK360



M.MT.B0280



M.MT.B0360AD

型号 Model	M.MT.BO280-A	M.MT.BSK360	M.MT.B0280	M.MT.B0360AD
电压 Voltage	220V	220V	220V/380V	220V/380V
功率 Power	550W	750W	1100W	1500W
电机转速 Motor speed	1400 rpm/min	1400 rpm/min	1400 rpm/min	1400 rpm/min
钢针用量 Steel needle quantity	0-600G	0-800G	0-600G x 2	0-800G x 2
抛光量 Polishing amount	2.5KG	3.5KG	2.5KG x 2	3.5KG x 2
外形尺寸 Outline size	430x430x930mm	500x500x930mm	700x380x1200mm	860x440x1200mm
重量 Weight	33KG	40KG	65KG	58KG



型号 Model	M.MT.P186	M.MT.P186S	M.MT.P0130	M.MT.P0100	M.MT.P0108	M.MT.P0090
电压 Voltage	110V/220V	110V/220V	110V/220V	110V/220V	110V/220V	110V/220V
转速 Speed	2000 rpm/min	2000 rpm/min	2000 rpm/min	500-2000 rpm/min	500-2000 rpm/min	2000 rpm/min
容量 Capacity	700g	700g	500g	400g	400g	400g
抛光桶尺寸 Polishing chamber size	180x110mm	180x110mm	136x100mm	110x100mm	110x100mm	110x100mm
外形尺寸 Outline size	280x280x360mm	280x280x360mm	230x230x320mm	200x200x290mm	180x180x280mm	160x160x280mm
重量 Weight	11kg	11kg	7kg	5.2kg	5kg	5kg

容量: 抛光针和饰件 Capacity: Polishing pins and accessories

磁力抛光机KT-185/KT-185S  
Magnetic polishing machine KT-185/KT-185S

型号 Model	M.MT.P185	M.MT.P185S
电压 Voltage	110V/220V	110V/220V
转速 Speed	2000 rpm/min	2000 rpm/min
容量 Capacity	700g	700g
抛光桶尺寸 Polishing chamber size	180x110mm	180x110mm
外形尺寸 Outline size	230x230x380mm	230x230x380mm
重量 Weight	10kg	11kg

容量: 抛光针和饰件 Capacity: Polishing pins and accessories



M.MT.P185



M.MT.P185S

磁力抛光机KT-205/KT-205S  
Magnetic polishing machine KT-205/KT-205S

型号 Model	M.MT.P0205	M.MT.P0205S
电压 Voltage	110V/220V	110V/220V
转速 Speed	2800 rpm/min	2800 rpm/min
容量 Capacity	900g	900g
抛光桶尺寸 Polishing chamber size	200x110mm	200x110mm
外形尺寸 Outline size	260x260x420mm	260x260x420mm
重量 Weight	15kg	15kg

容量: 抛光针和饰件 Capacity: Polishing pins and accessories



M.MT.P0205



M.MT.P0205S



M.MT.P360A



M.MT.P360-300



M.MT.P360S

磁力抛光机KT-306/KT-306A/M.MT.P360-300  
Magnetic polishing machine KT-306/KT-306A/M.MT.P360-300

型号 Model	M.MT.P360A	M.MT.P360-300	M.MT.P360S
电压 Voltage	110V/220V	110V/220V	110V/220V
转速 Speed	0-1900 rpm/min	0-1900 rpm/min	2800 rpm/min
容量 Capacity	1500g	1500g	1500g
抛光桶尺寸 Polishing chamber size	288x150mm	288x150mm	288x150mm
外形尺寸 Outline size	360x360x490mm	360x360x490mm	360x360x490mm
重量 Weight	25kg	26kg	26kg

容量: 抛光针和饰件 Capacity: Polishing pins and accessories

磁力抛光机KT-280A/KT-280C  
Magnetic polishing machine KT-280A/KT-280C

型号 Model	M.MT.P280	M.MT.P280C
电压 Voltage	110V/220V	110V/220V
转速 Speed	1400 rpm/min	0-1900 rpm/min
容量 Capacity	1200g	1200g
抛光桶尺寸 Polishing chamber size	252x145mm	252x145mm
外形尺寸 Outline size	310x310x460mm	310x310x460mm
重量 Weight	20kg	21kg



M.MT.P280



M.MT.P280C

容量: 抛光针和饰件 Capacity: Polishing pins and accessories

磁力抛光机KT-145/KT-150  
Magnetic polishing machine KT-145/KT-150

型号 Model	M.MT.P145	M.MT.P150
电压 Voltage	110V/220V	110V/220V
转速 Speed	2000 rpm/min	2000 rpm/min
容量 Capacity	600g	600g
抛光桶尺寸 Polishing chamber size	150x110mm	150x110mm
外形尺寸 Outline size	200x200x310mm	200x200x310mm
重量 Weight	6kg	6kg



M.MT.P145



M.MT.P150

容量: 抛光针和饰件 Capacity: Polishing pins and accessories



WS-18升湿式三头涡流机  
Wet type 18L polishing tumbler (triple)



应用范围

用于金银首饰、钟表眼镜配件、电子零件、纺织轮针及其他细薄精密五金件的去毛刺、倒角与精密抛光。替代人工或布轮打磨等传统低效率的作业方式，实现批量化、自动化的生产流程。

Application

Used for gold and silver jewelry, clocks and watches, glasses accessories, electronic parts, textile needle wheel and other thin precision hardware deburring, chamfering and precise polishing. Replace artificial or cloth round of polishing low efficiency of traditional practices, realizing mass, automation of production processes.

产品特点

漩涡式研磨抛光机采用多项专利技术，确保机器的整体结构科学合理与超细的间隙（0.05~0.1mm左右）以及良好的旋涡流动工作状态，使本机在加工复杂、细细薄工件时，具有更好的适用性。

- 1、美国杜邦聚氨酯（PU）桶体、转盘。
- 2、采用高耐磨陶瓷/合金间隙结构。
- 3、螺旋间隙调整结构。
- 4、具有自动散热功能。
- 5、变频控制系统，具有定时工作及正反转功能。
- 6、自动循环水装置。

Product Features

Gyrate polishing machine adopt patent technique ensure the machine has a reasonable structure, a very small gap (about 0.05~0.1 mm) and well work condition. The feature made machine use-friendly when polish the complicated and thin workpiece.

1. Grinding barrel and rotating disc are made of DuPont polyurethane (PU) .
2. The gap adopts the durable ceramic/alloy ring structure.
3. The gap is adjusted by means of helix device.
4. Automatic radiate heat function.
5. Inverter device, timer of the operation and normal/reversal rotation.
6. Automatic cycle water device.

名称 Denomination	型号 Model	容积 Volume	工作容积 Barrel capacity	电压 Voltage	功率 Power	外形尺寸 Outline size (LxWxH)	重量 Weight
WE-18升湿式涡流机	M.GM.WE018	18L	14L	220V, 50/60Hz	0.75KW	700x790x1440mm	140kg
WS-18升湿式双头涡流机	M.GM.WS018-2	2x18L	2x14L	220V, 50/60Hz	2x0.75KW	1160x790x1440mm	235kg
WS-18升湿式三头涡流机	M.GM.WE018-3	3x18L	3x14L	220V, 50/60Hz	3x0.75KW	1690x790x1440mm	330kg
WE-36升湿式涡流机	M.GM.WE036	36L	28L	380V, 50/60Hz	2.2KW	880x1000x1430mm	208kg



WF-36升干式涡流机  
Dry type 36L polishing tumbler (single)



WE-18升湿式涡流机  
Wet type 18L polishing tumbler (single)



WS-18升湿式双头涡流机  
Wet type 18L polishing tumbler (double)

40升涡流机 (干湿两用)  
40L polishing tumbler Machine (Wet & Dry type)

本机可广泛应用于各种行业的金属、塑胶、陶瓷等材料的工件去毛刺、倒角、去氧化皮、抛光等工序。特别是对形状复杂件、薄片易变形件提供了最理想的光整加工设备。

This machine can be widely used in various industries for deburring, chamfering, descaling, and polishing of workpieces made of metal, plastic, ceramic, and other materials. It is especially ideal for finishing complex-shaped parts and thin, easily deformable parts.



型号 Model	M.GM.W0040
电压 Voltage	380V/3PH/50Hz
容量 Capacity	40L
功率 Power	1.5KW
转速 Speed	0-180 rpm
抛光桶尺寸 Polishing chamber size	Φ400mm
机器尺寸 Machine Size	920x890x1180mm
重量 Weight	300kg



## LS-32立式离心研磨机 LS-32 vertical centrifugal grinding machine

### 产品特点

- 1、行星传动方式，利用离心运动原理，研磨效率高，比普通滚桶提高工效10至15倍。
- 2、适用批量小型的工件研磨抛光。
- 3、采用同步带传动，运转平稳，噪音小，使用寿命更长。
- 4、内桶采用进口聚氨脂胶，耐酸碱、耐磨。
- 5、本机采用电子刹车系统，操作更安全，免去人为操作的失误。
- 6、带变频调速功能，速度可以随时调节，减少不良率。
- 7、内置4个桶，均可拆下来的，方便清洗，4个桶可以同时进行研磨或抛光功能，或者同时加工不同类型的工件，易于分栋。

### 应用范围

LS-32立式离心研磨机适合铝压铸件、锌压铸件、钟表部件、锁、电子配件各类首饰、珠宝及粉末冶金、树脂等；用作多种行业种类零件的去刺、表面抛光、飞边、倒圆角、除氧化皮、除锈、强化金属表面、光亮抛光、电镀前及化学处理前的表面光整处理。

特别是以某些不能承受较大机械压力的薄壁、窄缝薄壁零件、异形复杂的腔孔的光整加工有其特异的优越功能，经该机型光整加工的零件，不破坏原有的形位精度，而且表面质量有所提高，起到工业美容的作用。

### Product Features

1. Planetary transmission mode, using the principle of centrifugal motion. Compared with the ordinary drum, the grinding efficiency is increased 10-15 times.
2. Suitable for grinding and polishing small batch workpieces.
3. Adopt synchronous belt transmission, smooth operation, low noise, long service life.
4. The inner barrel adopts imported polyurethane glue, acid and alkali resistant and wear-resisting.
5. This machine adopts electronic brake system, which makes the operation safer and avoids the mistake of human operation.
6. With frequency control function, the speed can be adjusted at any time to reduce the rate of defects.
7. There are four built-in drums, which can be removed for easy cleaning. The four drums can be ground or polished at the same time, or different types of workpiece can be processed at the same time, which is easy to be selected.

### Application

LS-32 vertical centrifugal grinding machine is suitable for aluminum die casting, zinc die casting, clock parts, locks, electronic accessories, all kinds of jewelries and powder metallurgy, resin, etc. It can be used for cutting, surface polishing, flapping, rounding, deoxidizing, derusting, strengthening metal surface, bright polishing, surface finishing before electroplating and chemical treatment of various kinds of parts in difference industries.

Particularly, the machine has superior function for the finishing processing of some thin parts, narrow seam thin parts and special-shaped complex cavity holes, which cannot stand the larger mechanical pressure. After the finishing processing by this machine, the original shape and accuracy of the parts won't be destroyed. The surface quality of the parts is improved. It plays the important role in industrial beauty.



型号 Model	容量 Capacity	电压 Voltage	磨料桶数量 Abrasive Barrels No	功率 Power	机器尺寸 Machine Size	重量 Weight
M.MT.LS-32	16L	220V 50/60HZ	4×4L	1.5KW	1120×880×912mm	398KG



### 分格式离心机 Segmented Centrifugal Polishing Machine

适用于五金、电子元器件等小零件去毛边、倒角、氧化层、抛光等高精密研磨抛光作业。本设备配备自动倒料、自动反转、变频调速。

Suitable for high-precision abrasive polishing of small parts such as hardware and electronic components, for deburring, chamfering, oxide layer removal, and polishing. This equipment features automatic material feeding, automatic reversal, and variable frequency speed control.

型号 Model	M.MT.00064
电压 Voltage	380V/3PH/50Hz
功率 Power	3.7KW
桶数量 Number of barrels	4x16个小格 / 4x16 compartments
机器尺寸 Machine Size	1600x1400x1600mm
重量 Weight	600kg



### LS-04立式离心研磨机 LS-04 Vertical centrifugal grinding machine

适合铝压铸件、锌压铸件、钟表部件、锁、电子配件各类首饰、珠宝及粉末冶金、树脂等；用作多种行业种类零件的去刺、表面抛光、飞边、倒圆角、除氧化皮、除锈、强化金属表面、光亮抛光、电镀前及化学处理前的表面光整处理。

suitable for aluminum die casting, zinc die casting, clock parts, locks, electronic accessories, all kinds of jewelries and powder metallurgy, resin, etc. It can be used for cutting, surface polishing, flapping, rounding, deoxidizing, derusting, strengthening metal surface, bright polishing, surface finishing before electroplating and chemical treatment of various kinds of parts in difference industries.

型号 Model	M.MT.B0034
电压 Voltage	220V
功率 Power	0.75KW
容量 Capacity	4 L
机器尺寸 Machine Size	710x500x610mm
重量 Weight	99KG



抛光前  
Casting Workpieces

抛光后  
After Electrolysis



### 双层干式滚筒研磨机 Dry barrel polishing machine with double layer

金银铜首饰、服饰配件，电子、塑胶类小零件去去锋(毛刺)、倒角、去斑、去氧化皮、抛光等高精密研磨抛光作业。

Suitable for jewelry products, clothing & accessories, electronic parts, plastic small parts for rough grinding, deburring, surface polishing finishing.



抛光前  
Casting Workpieces

抛光后  
After Electrolysis

型号 Model	容积 Volume	电压 Voltage	功率 Power	转速 Speed (rpm/min)	桶身尺寸 Barrel size	外形尺寸 Outline size (LxWxH)	重量 Weight
M.MT.GT022	600L	380V	0.75KW	33	700x1130mm	1720x850x1800mm	400kg

震动抛光机  
Vibration polishing machine



8寸震动抛光机SP-B  
8" Vibration polishing machine SP-B  
型号 Model: M.ZD.8SPB-1



12寸震动抛光机SP-7  
12" Vibration polishing machine SP-7  
型号 Model: M.ZD.12SP7



12寸震动抛光研磨机SP-A  
12" Vibration polishing machine SP-A  
型号 Model: M.ZD.12SPA



抛光前  
Before polishing



抛光后  
After polishing



17寸震动抛光机SP-A  
17" Vibration polishing machine SP-A  
型号 Model: M.ZD.17SPA



17寸震动抛光研磨机SP-C  
17" Vibration polishing machine SP-C  
型号 Model: M.ZD.17SPC

型号 Model	M.ZD.8SPB-1	M.ZD.12SP7	M.ZD.12SPA	M.ZD.17SPA	M.ZD.17SPC
电压 Voltage	110V/220V	110V/220V	110V/220V	110V/220V	110V/220V
功率 Power	150W	180W	180W	200W	180W
容量 Capacity	3KG	6.2KG	6.2KG	20KG	20KG
尺寸 Size	250x250x400mm	355x355x400mm	355x355x400mm	430x430x410mm	355x355x400mm
重量 Weight	8KG	14KG	14KG	23KG	20KG



槽式振机  
Trough-type vibratory finishing machine

适用于小批量小型结构尺寸的金属与非金属材质工件的光整光饰、表面处理，有效去除工件表面的毛刺、毛边、披锋、棱角、锈迹、污迹。

Suitable for the finishing and surface treatment of small batches of metal and non-metallic workpieces with small structural dimensions, effectively removing burrs, sharp edges, flash, corners, rust, and stains from the workpiece surface.

型号 Model	M.MT.VP-30
电压 Voltage	380V
功率 Power	0.55KW
机器尺寸 Machine Size	720x360x620mm
重量 Weight	110KG

### 振动研磨机 (带变频) Vibratory Polishing Machine (with frequency converter)

可适用于批量生产的中、小型结构尺寸的金属与非金属材质零件的表面处理, 有效去除工件表面的毛刺、飞边、披锋、棱角、锈迹等, 使零件表面达到一定的光洁度、光整度和光亮度。

This machine is suitable for surface treatment of small and medium-sized metal and non-metal parts in batch production. It effectively removes burrs, flash, sharp edges, and rust from the surface of workpieces, resulting in a certain degree of smoothness, evenness, and brightness.



型号 Model	M.ZD.SPA60-Q
电压 Voltage	380V/3PH/50Hz
功率 Power	0.75KW
马力 HP	1HP
容量 Capacity	60L
填充量 Filling quantity	150KG
机器尺寸 Machine Size	Φ730xH715mm
重量 Weight	260kg

### 滚桶抛光机 Barrel polishing machine



滚桶抛光机KT-6808  
Barrel polishing machine KT-6808  
型号 Model: M.MT.GT001



滚桶抛光机KT-2000  
Barrel polishing machine KT-2000  
型号 Model: M.MT.GT002



滚桶抛光机KT-245  
Barrel polishing machine KT-245  
型号 Model: M.MT.GT003



电子滚动抛光机KT-250  
Electronic barrel polishing machine KT-250  
型号 Model: M.MT.GT004



滚桶抛光机KT-3010  
Barrel polishing machine KT-3010  
型号 Model: M.MT.GT005

型号 Model	M.MT.GT001	M.MT.GT002	M.MT.GT003	M.MT.GT004	M.MT.GT005
电压 Voltage	110V/220V	110V/220V	110V/220V	110V/220V	110V/220V
功率 Power	60W	150W	150	150W	250W
容量 Capacity	3KG	5KG	8KG	8KG	12KG
抛光桶 Polishing barrel	145x150mm	190x180mm	250x220mm	250x220mm	300x240mm
尺寸 Size	230x180x240mm	280x220x290mm	298x222x325mm	298x222x325mm	370x390x430mm
重量 Weight	5KG	6KG	12KG	12KG	15KG



滚桶抛光机1320  
Barrel polishing machine 1320

型号 Model	M.MT.GT006
电压 Voltage	110V/220V
功率 Power	300W
容量 Capacity	11KG
尺寸 Size	570x210x390mm
重量 Weight	18KG

单桶 / 双桶可选  
Single polishing barrel / Double polishing barrel for option  
尺寸 Size: 235x310mm, 210x130mm × 2



变频双桶抛光机KT620  
Barrel polishing machine 1320

型号 Model	M.MT.GT009
电压 Voltage	110V/220V
功率 Power	750W
容量 Capacity	20KG
抛光桶 Polishing barrel	310x290mm
尺寸 Size	1000x450x650mm
重量 Weight	50KG



台式滚桶抛光机KT-4200  
Barrel polishing machine 1320

型号 Model	M.MT.G4200
电压 Voltage	110V/220V
容量 Capacity	40KG
抛光桶 Polishing barrel	420x300mm
尺寸 Size	670x3560x630mm
重量 Weight	50KG



**30型滚桶抛光机**  
30 type barrel polishing machine  
型号 Model: M.MT.GT050  
电压 Voltage: 110-220V  
容量 Capacity: 0.6L  
抛光桶 Polishing barrel: 105x97mm  
尺寸 Size: 220x160x170mm



**20型滚桶抛光机**  
20 type barrel polishing machine  
型号 Model: M.MT.GT052  
电压 Voltage: 110-220V  
速度 Speed: 360rpm  
容量 Capacity: 0.9L  
抛光桶 Polishing barrel: 115x125mm  
尺寸 Size: 370x170x180mm



**50型滚桶抛光机**  
50 type barrel polishing machine  
型号 Model: M.MT.GT053  
电压 Voltage: 110-220V  
速度 Speed: 360rpm  
容量 Capacity: 0.6L  
抛光桶 Polishing barrel: 105x97mm  
尺寸 Size: 220x160x170mm  
重量 Weight: 2.5KG

**10型滚桶抛光机**  
10 type barrel polishing machine  
型号 Model: M.MT.GT051  
电压 Voltage: 110-220V  
速度 Speed: 360rpm  
容量 Capacity: 0.9L  
抛光桶 Polishing barrel: 115x125mm  
尺寸 Size: 250x170x180mm  
重量 Weight: 2.7KG



**吸尘抛光机H3600**  
Polishing machine H3600  
型号 Model: M.MT.H3600  
电压 Voltage: 220V  
功率 Power: 550W  
尺寸 Size: 540x350x310mm  
重量 Weight: 23.6KG



**抛光机H4300**  
Polishing machine H4300  
型号 Model: M.MT.H4300  
电压 Voltage: 220V  
功率 Power: 430W  
尺寸 Size: 400x300x370mm  
重量 Weight: 13.4KG



**吸尘布轮抛光机**  
Dust collection polishing machine  
型号 Model: M.MT.DM008-1  
电压 Voltage: 110V/220V  
功率 Power: 750W  
速度 Speed: 0-4300rpm

**小型双轴打磨机**  
Mini double heads grinding machine



型号 Model: M.MT.DM010  
电压 Voltage: 110-220V  
功率 Power: 250W  
速度 Speed: 500-7000rpm



型号 Model: M.MT.DM011  
电压 Voltage: 110-220V  
功率 Power: 200W  
速度 Speed: 500-8000rpm  
尺寸 Size: 380x240x250mm



型号 Model: M.MT.DM012  
电压 Voltage: 110-220V  
功率 Power: 150W  
速度 Speed: 500-6000rpm  
尺寸 Size: 240x180x150mm



小型单头打磨机  
Small one head grinding machine

型号 Model: M.MT.DM002  
电压 Voltage: 110V/220V  
功效 Power: 550W  
尺寸 Size: 660x330x190mm  
重量 Weight: 22KG



双头吸尘打磨机  
Double heads dust collection grinding machine

型号 Model: M.MT.DM001  
电压 Voltage: 110V/220V  
打磨马达 Polishing Motor: 1/2HP  
吸入马达 Suction Motor: 1/2HP  
速度 Speed: 2800rpm  
尺寸 Size: 680x540x340mm  
重量 Weight: 43KG



吸尘抛光机DM-5  
Dust collection polishing machine DM-5

型号 Model: M.MT.DM005-A  
电压 Voltage: 110V/220V  
功率 Power: 200W  
速度 Speed: 500-7000rpm  
尺寸 Size: 490x340x260mm  
重量 Weight: 11KG



变频高速吸尘打磨机DM-6  
Frequency conversion speed dust collection grinding machine DM-6

型号 Model: M.MT.DM006-A  
电压 Voltage: 110V/220V  
打磨马达 Polishing Motor: 1/2HP匹  
吸入马达 Suction Motor: 1/2HP匹  
速度 Speed: 500-3600rpm  
尺寸 Size: 550x420x300mm  
重量 Weight: 28KG



双头吸尘抛光机H3700S  
Double sides polishing machine H3700S

型号 Model: M.MT.H3700S  
电压 Voltage: 220V  
功率 Power: 690W  
尺寸 Size: 795x490x300mm  
重量 Weight: 34KG

分体式潜水抛光机KT-400  
Under water polishing machine KT-400

型号 Model	M.MT.G4200-B
电压 Voltage	220V
功率 Power	550W
容量 Capacity	20KG
抛光桶 Polishing barrel	320x200mm
尺寸 Size	290x310x720mm
重量 Weight	48KG





**小型双头打磨机**  
Small double heads grinding machine  
型号 Model: M.MT.DM003  
电压 Voltage: 220V  
功效 Power: 200W  
外形尺寸 Outline size: L330xH130mm  
重量 Weight: 3.4KG



**布轮抛光机**  
Buff grinding machine  
型号 Model: M.MT.DM003-B  
电压 Voltage: 220V  
功效 Power: 180W  
外形尺寸 Outline size: L330xH130mm  
重量 Weight: 3.5KG



**布轮抛光机**  
Buff grinding machine  
型号 Model: M.MT.DM007  
电压 Voltage: 220V  
功效 Power: 200W  
速度 Speed: 500-7000rpm



**打磨机**  
Polishing machine  
型号 Model: M.MT.DM008  
电压 Voltage: 10V/220V  
功效 Power: 200W  
速度 Speed: 500-7000rpm

**多功能切割磨光机**  
Multi functional cutting and polishing machine

型号 Model	M.MT.B0042
电压 Voltage	220V
功效 Power	200W
速度 Speed	500-7000rpm
外形尺寸 Outline size	300x250x160mm
重量 Weight	7kg



**打磨机**  
Brush micromotor

型号 Model	M.MT.DM011
电压 Voltage	110V/60Hz, 220V/50Hz
功率 Power	65W
重量 Weight	1.38kg



韩国精密磨打机206  
Brush micromotor 206

型号 Model	M.MT.DM206
电压 Voltage	220V
速度 Speed	5500-45000rpm



SP-A90电子打磨机  
SP-A90 brush micromotor

型号 Model	M.MT.DMA90
电压 Voltage	110V/60Hz, 220V/50Hz
功率 Power	65W
速度 Speed	35000rpm



进口精密打磨机407  
Imported precision brush micromotor 407

型号 Model	M.MT.DM407
电压 Voltage	220V
功率 Power	230W
外形尺寸 Outline size	160x210x100mm
重量 Weight	2.31KG



韩国磨打机204  
Korea 204 brush micromotor

型号 Model	M.MT.DM204
电压 Voltage	110V/220V
功率 Power	65W
速度 Speed	35000rpm



N4打磨机  
N4 brush micromotor

型号 Model	M.MT.N4
电压 Voltage	110V/60Hz, 220V/50Hz
功率 Power	65W
速度 Speed	35000rpm



N3+H37L1打磨机  
N3+H37L1 brush micromotor

型号 Model	M.MT.H37L1-C
电压 Voltage	110V/60Hz, 220V/50Hz
功率 Power	65W
速度 Speed	35000rpm



207B+102LN打磨机  
207B+102LN brush micromotor

型号 Model	M.MT.DM207B
电压 Voltage	110V/60Hz, 220V/50Hz
功率 Power	65W
速度 Speed	35000rpm



世洋H37L1打磨机  
Saeyang H37L1 brush micromotor

型号 Model	M.MT.H37L1
电压 Voltage	11V/220V
速度 Speed	35000rpm
外形尺寸 Outline size	118x156x78mm
重量 Weight	1.25KG



世洋N7M45打磨机  
Saeyang N7M45 brush micromotor

型号 Model	M.MT.N7M45
电压 Voltage	11V/220V
速度 Speed	45000rpm
外形尺寸 Outline size	115x147x88mm
重量 Weight	1.2KG



世洋NY-SH37LN-FS60打磨机  
Saeyang NY-SH37LN-FS60 brush micromotor

型号 Model	M.MT.NYSH37LN
功率 Power	70W
速度 Speed	0-45000rpm
外形尺寸 Outline size	250x250x200mm
重量 Weight	2.5KG





KT-A02吊磨机  
KT-A02 flex shaft

型号 Model: M.FS.00A02  
 焊针直径 Welding pen diameter:  $\Phi 4\text{mm}/\Phi 6\text{mm}$   
 电源 Power supply: 110V/220V  
 频率 Frequency: 50/60Hz  
 输入功率 Power input: 200W  
 负载速度 Rotating speed: 500/20000r/min



KT-A03吊磨机  
KT-A03 flex shaft

型号 Model: M.FS.00A03  
 焊针直径 Welding pen diameter:  $\Phi 4\text{mm}/\Phi 6\text{mm}$   
 电源 Power supply: 110V/220V  
 频率 Frequency: 50/60Hz  
 输入功率 Power input: 200W  
 负载速度 Rotating speed: 500/20000r/min



KT-A04吊磨机  
KT-A04 flex shaft

型号 Model: M.FS.00A04  
 焊针直径 Welding pen diameter:  $\Phi 4\text{mm}/\Phi 6\text{mm}$   
 电源 Power supply: 110V/220V  
 频率 Frequency: 50/60Hz  
 输入功率 Power input: 200W  
 负载速度 Rotating speed: 500/20000r/min



KT-A05吊磨机  
KT-A05 flex shaft

型号 Model: M.FS.00A05  
 焊针直径 Welding pen diameter:  $\Phi 4\text{mm}/\Phi 6\text{mm}$   
 电源 Power supply: 110V/220V  
 频率 Frequency: 50/60Hz  
 输入功率 Power input: 180W  
 负载速度 Rotating speed: 500/18000r/min



KT-A06吊磨机  
KT-A06 flex shaft

型号 Model: M.FS.00A06  
 焊针直径 Welding pen diameter:  $\Phi 4\text{mm}/\Phi 6\text{mm}$   
 电源 Power supply: 110V/220V  
 频率 Frequency: 50/60Hz  
 输入功率 Power input: 200W  
 负载速度 Rotating speed: 500/24000r/min



KT-A07吊磨机  
KT-A07 flex shaft

型号 Model: M.FS.00A07  
 焊针直径 Welding pen diameter:  $\Phi 4\text{mm}/\Phi 6\text{mm}$   
 电源 Power supply: 110V/220V  
 频率 Frequency: 50/60Hz  
 输入功率 Power input: 180W  
 负载速度 Rotating speed: 500/18000r/min



KT-A08吊磨机  
KT-A08 flex shaft

型号 Model: M.FS.00A08  
 焊针直径 Welding pen diameter:  $\Phi 4\text{mm}/\Phi 6\text{mm}$   
 电源 Power supply: 110V/220V  
 频率 Frequency: 50/60Hz  
 输入功率 Power input: 180W  
 负载速度 Rotating speed: 500/18000r/min



KT-A09吊磨机  
KT-A09 flex shaft

型号 Model: M.FS.00A09  
 焊针直径 Welding pen diameter:  $\Phi 4\text{mm}/\Phi 6\text{mm}$   
 电源 Power supply: 110V/220V  
 频率 Frequency: 50/60Hz  
 输入功率 Power input: 180W  
 负载速度 Rotating speed: 500/19000r/min



KT-A10吊摩机  
KT-A10 flex shaft

型号 Model: M.FS.00A10  
 焊针直径 Welding pen diameter:  $\Phi 4\text{mm}/\Phi 6\text{mm}$   
 电源 Power supply: 110V/220V  
 频率 Frequency: 50/60Hz  
 输入功率 Power input: 180W  
 负载速度 Rotating speed: 500/18000r/min



KT-A11吊摩机  
KT-A11 flex shaft

型号 Model: M.FS.00A11  
 焊针直径 Welding pen diameter:  $\Phi 4\text{mm}/\Phi 6\text{mm}$   
 电源 Power supply: 110V/220V  
 频率 Frequency: 50/60Hz  
 输入功率 Power input: 180W  
 负载速度 Rotating speed: 500/17000r/min



KT-A12吊摩机  
KT-A12 flex shaft

型号 Model: M.FS.00A12  
 焊针直径 Welding pen diameter:  $\Phi 4\text{mm}/\Phi 6\text{mm}$   
 电源 Power supply: 110V/220V  
 频率 Frequency: 50/60Hz  
 输入功率 Power input: 180W  
 负载速度 Rotating speed: 500/5000r/min



KT-A13吊摩机  
KT-A13 flex shaft

型号 Model: M.FS.00A13  
 焊针直径 Welding pen diameter:  $\Phi 4\text{mm}/\Phi 6\text{mm}$   
 电源 Power supply: 110V/220V  
 频率 Frequency: 50/60Hz  
 输入功率 Power input: 200W  
 负载速度 Rotating speed: 500/20000r/min



KT-A15吊磨机  
KT-A15 flex shaft

型号 Model: M.FS.00A15  
焊针直径 Welding pen diameter:  $\Phi 4\text{mm}/\Phi 6\text{mm}$   
电源 Power supply: 110V/220V  
频率 Frequency: 50/60Hz  
输入功率 Power input: 200W  
负载速度 Rotating speed: 500/20000r/min



CC-30金科达吊磨机  
CC-30 flex shaft

型号 Model: M.FS.00001  
焊针直径 Welding pen diameter:  $\Phi 2.35\text{mm}/\Phi 4.5\text{mm}$   
电源 Power supply: 110V/220V  
频率 Frequency: 50/60Hz  
输入功率 Power input: 200W  
负载速度 Rotating speed: 500/20000r/min



CH330保利吊磨机  
CH330 poli flex shaft

型号 Model: M.FS.00003  
焊针直径 Welding pen diameter:  $\Phi 2.35\text{mm}/\Phi 4.5\text{mm}$   
电源 Power supply: 110V/220V  
频率 Frequency: 50/60Hz  
输入功率 Power input: 200W  
负载速度 Rotating speed: 500/18000r/min



SR吊磨机  
SR flex shaft

型号 Model: M.FS.00004  
焊针直径 Welding pen diameter:  $\Phi 2.35\text{mm}/\Phi 4.5\text{mm}$   
电源 Power supply: 110V/220V  
频率 Frequency: 50/60Hz  
输入功率 Power input: 200W  
负载速度 Rotating speed: 500/20000r/min



意大利吊磨机  
Pflingst flex shaft

型号 Model: M.FS.00005  
 焊针直径 Welding pen diameter:  $\Phi 2.35\text{mm}/\Phi 4.5\text{mm}$   
 电源 Power supply: 110V/220V  
 频率 Frequency: 50/60Hz  
 输入功率 Power input: 200W  
 负载速度 Rotating speed: 500/20000r/min



吊磨机SL10-128A  
Flex shaft SL10-128A

型号 Model: M.FS.SL128  
 焊针直径 Welding pen diameter:  $\Phi 4\text{mm}$   
 电源 Power supply: 110V/220V  
 频率 Frequency: 50/60Hz  
 输入功率 Power input: 250W  
 负载速度 Rotating speed: 0-24000r/min



KV002吊磨机  
KV002 flex shaft

型号 Model: M.FS.00013  
 焊针直径 Welding pen diameter:  $\Phi 2.3\text{mm}/\Phi 3\text{mm}/\Phi 4\text{mm}/\Phi 6\text{mm}$   
 电源 Power supply: 110V/240V  
 频率 Frequency: 50/60Hz  
 输入功率 Power input: 600W  
 负载速度 Rotating speed: 500/25000r/min



KV003吊磨机  
KV003 flex shaft

型号 Model: M.FS.00014  
 焊针直径 Welding pen diameter:  $\Phi 4\text{mm}/\Phi 6\text{mm}$   
 电源 Power supply: 110V/220V  
 频率 Frequency: 50/60Hz  
 输入功率 Power input: 180W  
 负载速度 Rotating speed: 500/20000r/min

金科达吊磨机配件  
Foredom flex shaft accessories



吊磨机大头  
Grinding head

型号 Model: M.FS.P1001



吊磨机内芯  
Inner core

型号 Model: M.FS.P1002



吊磨机外喉  
Outer core

型号 Model: M.FS.P1003



吊磨机脚踏  
Foot pedal

型号 Model: M.FS.P1004



吊磨机接头  
Connector

型号 Model: M.FS.P1006



吊磨机转子  
Rotor of flex shaft

型号 Model: M.FS.P1008



吊磨机定子  
Stator of flex shaft

型号 Model: M.FS.P1009



吊磨机碳刷  
Carbon brush

型号 Model: M.FS.P1010

保利达吊磨机配件  
Poli flex shaft accessories



吊磨机大头  
Grinding head

型号 Model: M.FS.P2001



吊磨机内芯  
Inner core

型号 Model: M.FS.P2002



吊磨机外喉  
Outer core

型号 Model: M.FS.P2003



吊磨机脚踏  
Foot pedal

型号 Model: M.FS.P2004



吊磨机接头  
Connector

型号 Model: M.FS.P2005



吊磨机碳刷  
Carbon brush

型号 Model: M.FS.P2006



吊磨机脚踏绝缘陶瓷板  
Foot pedal insulation ceramic plate

型号 Model: M.FS.P2007

SR吊磨机配件  
SR flex shaft accessories



吊磨机大头  
Grinding head

型号 Model: M.FS.P3008



吊磨机内芯  
Inner core

型号 Model: M.FS.P3003



吊磨机外喉  
Outer core

型号 Model: M.FS.P3004



吊磨机脚踏  
Foot pedal

型号 Model: M.FS.P3007



吊磨机转子  
Rotor of flex shaft

型号 Model: M.FS.P3005



吊磨机碳刷  
Carbon brush

型号 Model: M.FS.P3001



T30吊磨机细头  
T30 handpiece  
M.FS.P0004



T38细头  
T38 handpiece  
M.FS.P0005



T30吊磨机细头  
T30 handpiece  
M.FS.P0002-N



T30吊磨机细头  
T30 handpiece  
M.FS.P0002-G



B型磨头  
B type grinding head  
型号 Model: M.FS.P4007



B型外喉  
B type outer core  
型号 Model: M.FS.P4005



B型内喉  
B type Inner core  
型号 Model: M.FS.P4006



AGP吊磨机碳刷  
Carbon brush of AGP flex shaft  
型号 Model: M.FS.P4008



SL10-128A脚踏电子调速开关  
Fott Pedal electronic speed switch (SL10-128A)  
型号 Model: M.FS.P4004



摩机脚踏电子开关  
Pedal electronic switch  
型号 Model: M.FS.P1005  
金科达/保利通用  
Foredom/Poli General



吊磨机轴承  
Bearing of flex shaft  
型号 Model: M.FS.P1007  
金科达/保利通用  
Foredom/Poli General



SL10-128A脚踏开关瓷板  
Pedal switch ceramic plate (SL10-128A)  
型号 Model: M.FS.P4003



手柄匙  
Handle key  
型号 Model: M.FS.P2008  
金科达/保利/SR通用  
Foredom/Poli/SR General



手柄匙  
Chuck key  
M.FS.P2008



SL10-128A脚踏开关加长线  
SL10-128A Foot pedal switch (extension line)  
型号 Model: M.FS.P4002



台式手柄架  
Handpiece holder  
M.FS.P0075



电刻笔  
Electric engraver  
M.SP.00016-B 220V/8W/260G



**蒸汽清洗机**  
**Steam cleaning machine**

型号 Model: M.ST.A0002-A  
电压 Voltage: 220V  
蒸汽功率 Steam Power: 1200W  
温度 Temperature: 140°  
实际水量 Actual Water : 1.2L  
锅炉容积 Boiler Volume: 2L  
蒸汽排放 Steam Drang: 4KG  
尺寸 Size: 180x280x320mm



**蒸汽清洗机**  
**Steam cleaning machine**

型号 Model: M.ST.A0002-B  
电压 Voltage: 220V  
蒸汽功率 Steam Power: 1200W  
温度 Temperature: 150°  
实际水量 Actual Water : 1.2L  
锅炉容积 Boiler Volume: 2L  
蒸汽排放 Steam Drang: 2-5KG  
尺寸 Size: 200x310x330mm



**蒸汽清洗机**  
**Steam cleaning machine**

型号 Model: M.ST.A0003-4  
电压 Voltage: 220V  
蒸汽功率 Steam Power: 2400W  
温度 Temperature: 140°  
实际水量 Actual Water : 2.2L  
锅炉容积 Boiler Volume: 3L  
蒸汽排放 Steam Drang: 4KG  
尺寸 Size: 240x380x390mm



**蒸汽清洗机**  
**Steam cleaning machine**

型号 Model: M.ST.A0003-6  
电压 Voltage: 220V  
蒸汽功率 Steam Power: 2400W  
温度 Temperature: 152°  
实际水量 Actual Water : 2.2L  
锅炉容积 Boiler Volume: 3L  
蒸汽排放 Steam Drang: 6KG  
尺寸 Size: 240x380x390mm



**蒸汽清洗机**  
**Steam cleaning machine**

型号 Model: M.ST.A0003-8  
电压 Voltage: 220V  
蒸汽功率 Steam Power: 2400W  
温度 Temperature: 165°  
实际水量 Actual Water : 2.2L  
锅炉容积 Boiler Volume: 3L  
蒸汽排放 Steam Drang: 8KG  
尺寸 Size: 240x380x390mm



**蒸汽清洗机**  
**Steam cleaning machine**

型号 Model: M.ST.A0003-A  
电压 Voltage: 220V  
蒸汽功率 Steam Power: 2900W  
温度 Temperature: 140-165°C°  
实际水量 Actual Water : 1.2L  
锅炉容积 Boiler Volume: 3L  
蒸汽排放 Steam Drang: 4-8KG  
尺寸 Size: 240x380x390mm



**蒸汽清洗机**  
**Steam cleaning machine**

型号 Model: M.ST.A0004  
电压 Voltage: 220V/110V  
功率 Power: 1600W  
蒸汽压力 Steam pressure: 5-6 Bar  
锅炉容积 Boiler Volume: 4L  
尺寸 Size: 340x310x350mm  
重量 Weight: 11KG



**蒸汽清洗机**  
**Steam cleaning machine**

电压 Voltage: 220V/110V  
功率 Power: 1600W  
蒸汽压力 Steam pressure: 4-5 Bar  
锅炉容积 Boiler Volume: 2L  
尺寸 Size: 240x310x350mm  
重量 Weight: 10KG



**蒸汽清洗机**  
**Steam cleaning machine**

型号 Model: M.ST.A0002  
电压 Voltage: 220V/50Hz  
功率 Power input: 4000W  
容量 Capacity: 2.5L  
主机尺寸 Size: 435x300x355mm  
水箱尺寸 Tank size: 230x180x245mm  
重量 Weight: 19.5Kg



**12升自动加水蒸汽清洗机**  
**12L steamer with automatic water addition**

型号 Model: M.ST.00012-2  
电压 Voltage: 220V  
功率 Power: 3500W

单头吸尘抛光机  
One side buff polishing machine

型号 Model	M.MT.Z100E
电压 Voltage	220V
打磨功率 Power	750W
吸尘功率 Sucking power	550W
重量 Weight	80kg
转速 Speed (rpm/min)	2800
外形尺寸 Outline size	900x586x1250mm

可订制110V Can customeice 110V



双头双位吸尘抛光机  
Two sides two position buff polishing machine

型号 Model	M.MT.Z200E
电压 Voltage	220V
打磨功率 Power	750W
吸尘功率 Sucking power	750W
重量 Weight	131kg
转速 Speed (rpm/min)	2800
外形尺寸 Outline size	1600x580x1185mm

可订制110V Can customeice 110V



双头双位吸尘抛光机  
Two sides two position buff polishing machine

型号 Model	M.MT.Z200E-DZ
电压 Voltage	220V
打磨功率 Power	750W
吸尘功率 Sucking power	750W
重量 Weight	125kg
转速 Speed (rpm/min)	2800
外形尺寸 Outline size	1530x525x1185mm



双头双位吸尘抛光机  
Two sides two position buff polishing machine

型号 Model	M.MT.PM-7000D
电压 Voltage	220V
打磨功率 Power	750W
吸尘功率 Sucking power	4000W
转速 Speed (rpm/min)	4000
外形尺寸 Outline size	1600×1150×1555mm



单头布轮抛光机  
One side buff polishing machine

型号 Model	M.MT.B0001
电压 Voltage	220V
功率 Power	550W
外形尺寸 Outline size	950x500x1170mm

可订制110V Can custumice 110V



双头布轮抛光机  
Double sides buff polishing machine

型号 Model	M.MT.B0002
电压 Voltage	220V
功率 Power	550W+550W
外形尺寸 Outline size	1470x500x1170mm

可订制110V Can custumice 110V



单头飞碟抛光机  
One head split lapping machine

型号 Model	M.MT.B0003
电压 Voltage	220V
功率 Power	550W
外形尺寸 Outline size	950x500x1170mm

可订制110V Can customice 110V



抛光一体机(加双变频)  
All-in-one polishing machine  
(dual-frequency converting)

型号 Model	M.MT.B0015
电压 Voltage	220V
功率 Power	550W
外形尺寸 Outline size	950x500x1170mm

可订制110V Can customice 110V



不锈钢双头布轮抛光机(带调速)  
Stainless steel double sides buff  
polishing machine (with speed regulation)

型号 Model	M.MT.B0013
电压 Voltage	220V
功率 Power	550W+550W
外形尺寸 Outline size	1480x570x1130mm

可订制110V Can customice 110V



双头吸尘布轮抛光机  
Double side dust buff polishing machine

型号 Model	M.MT.B0023
电压 Voltage	220V
功率 Power	550W+550W
外形尺寸 Outline size	1470x500x1170mm

可订制110V Can customice 110V



超声波清洗机  
Ultrasonic cleaning machine



名称 Description	型号 Model	电压 Voltage	超声功率 Ultrasonic power	加热功率 Heating power	清洗槽尺寸 Cleaning tank size
6头超声波清洗机 Ultrasonic cleaning machine	M.UC.A1006	220V	300W	1KW	290×200×230mm
12头超声波清洗机 Ultrasonic cleaning machine	M.UC.A1012	220V	600W	2KW	370×280×300mm
18头超声波清洗机 Ultrasonic cleaning machine	M.UC.A1018	220V	900W	4KW	460×330×400mm
24头超声波清洗机 Ultrasonic cleaning machine	M.UC.A1024	220V	1200W	4KW	600×400×400mm
30头超声波清洗机 Ultrasonic cleaning machine	M.UC.A1030	220V	1500W	6KW	600×500×400mm
36头超声波清洗机 Ultrasonic cleaning machine	M.UC.A1036	220V	1800W	6KW	650×500×400mm
40头超声波清洗机 Ultrasonic cleaning machine	M.UC.A1040	220V-380V	2000W	9KW	700×500×400mm
48头超声波清洗机 Ultrasonic cleaning machine	M.UC.A1048	220V-380V	2400W	9KW	700×500×400mm
72头超声波清洗机 Ultrasonic cleaning machine	M.UC.A1072	220V-380V	3600W	12KW	800×550×500mm

## 超声波清洗机 Ultrasonic cleaning machine

1. 304不锈钢内胆，加厚无焊点、无缝隙。
2. 具有很好的耐高温、防腐蚀、耐磨损、耐热性。
3. 操作简单，除污快，振幅强。
4. 温度可调：0-80°C，时间可调：1-30min。

1. 304 stainless steel inner tank, thickened with no weld points or seams.
2. It exhibits excellent high-temperature resistance, corrosion resistance, wear resistance, and heat resistance.
3. Simple operation, fast cleaning, and powerful vibration.
4. Temperature adjustable: 0-80°C  
Time adjustable: 1-30 minutes.



清洗槽  
Cleaning tank



排水口  
Outfall



M.UC.E0102



M.UC.E0203



M.UC.E0204 / M.UC.E0304



M.UC.E0306



M.UC.E0410



M.UC.E0615



M.UC.E0822



M.UC.E1030

名称 Description	型号 Model	电压 Voltage	清洗槽尺寸 Cleaning tank size	外形尺寸 Outline size	毛重 G.M.
1头2升超声波清洗机 1-head 2L ultrasonic cleaning machine	M.UC.E0102	110V/220V	150x135x100mm	180x165x225mm	2.3kg
2头3升超声波清洗机 2-head 3L ultrasonic cleaning machine	M.UC.E0203	110V/220V	240x135x100mm	265x165x225mm	3.4kg
2头4升超声波清洗机 2-head 4L ultrasonic cleaning machine	M.UC.E0204	110V/220V	300x150x100mm	325x175x230mm	4.5kg
3头4升超声波清洗机 3-head 4L ultrasonic cleaning machine	M.UC.E0304	110V/220V	300x150x100mm	325x175x230mm	4.5kg
3头6升超声波清洗机 3-head 6L ultrasonic cleaning machine	M.UC.E0306	110V/220V	300x150x150mm	325x175x275mm	5.2kg
4头10升超声波清洗机 4-head 10L ultrasonic cleaning machine	M.UC.E0410	110V/220V	300x240x150mm	330x270x280mm	6.7kg
6头15升超声波清洗机 6-head 15L ultrasonic cleaning machine	M.UC.E0615	110V/220V	330x300x150mm	355x325x275mm	9.2kg
8头22升超声波清洗机 8-head 22L ultrasonic cleaning machine	M.UC.E0822	110V/220V	500x300x150mm	530x330x275mm	11.5kg
10头30升超声波清洗机 10-head 30L ultrasonic cleaning machine	M.UC.E1030	110V/220V	500x300x200mm	530x330x330mm	13.6kg

**数码超声波清洗机**  
Digital ultrasonic cleaning machine

**产品特点:**

外壳采用优质防指纹不锈钢压花板制作, 美观大方。  
清洗槽采用优质SUS304不锈钢一次冲压成形, 无焊接, 防水性能好。  
采用德国最先进的换能器粘接工艺, 实现清洗槽内无焊接印进一步提高换能器转换效率及其使用寿命。  
业内首创休眠模式, 一键唤醒功能, 更节能、更安全。  
独有脱气功能, 实现真正意义的超声真空, 电路转换效率高: 98%, 无功损耗极低。  
工作时间数码控制, LED数字显示1-99分钟任意可调, 满足不同的清洗需求; 清洗温度在0-80°C范围内任意可调。  
6升以上含排水口及散热装置

**技术参数**

- 1、使用电压: 220V 50Hz
- 2、超声频率: 40KHz

**Product Features:**

- 1. The shell is made of high quality anti-fingerprint stainless steel embossed plate, nice.
- 2. A cleaning tank made of high quality SUS304 stainless steel stamping, no welding is good, waterproof performance.
- 3. Germany's most advanced transducer bonding process to achieve the cleaning tank without welding and India to further improve the conversion efficiency of the transducer and its service life.
- 4. The industry's first sleep mode, a key-on wakeup function, more energy efficient and safer.
- 5. The unique degas function, the real significance of ultrasound vacuum circuit high conversion efficiency: 98%, reactive power loss is very low.
- 6. The working time digital control, LED digital display 1-99 minutes adjustable, to meet the different needs cleaning; cleaning temperature in the range of 0-80 °C adjustable.



内槽 Tank



排水口 Outfall

**Technical Parameters**

- 1. Voltage: 220V 50Hz
- 2. Ultrasonic frequency: 40KHz



型号 Model: M.UC.230HD



型号 Model: M.UC.240HD



型号 Model: M.UC.340HD



型号 Model: M.UC.360HD



型号 Model: M.UC.410HD



型号 Model: M.UC.615HD



型号 Model: M.UC.820HD



型号 Model: M.UC.1030HD

名称 Description	型号 Model	功率 Power	时间可调 Adjustable time	温度可调 Adjustable temperature	容积 capacity	清洗槽尺寸 Cleaning tank size	外形尺寸 Outer size
2头3升超声波清洗机 3L Ultrasonic cleaning machine	M.UC.230HD	120W	1~99	0~80°C	3.2L	224x140x100mm	270x170x240mm
2头4升超声波清洗机 4L Ultrasonic cleaning machine	M.UC.240HD	120W			4.5L	300x155x100mm	312x162x240mm
3头4升超声波清洗机 4L Ultrasonic cleaning machine	M.UC.340HD	180W			4.5L	300x155x100mm	312x162x240mm
3头6升超声波清洗机 6L Ultrasonic cleaning machine	M.UC.360HD	180W			6.5L	300x155x150mm	330x180x330mm
4头10升超声波清洗机 10L Ultrasonic cleaning machine	M.UC.410HD	240W			10L	300x240x150mm	330x270x330mm
6头15升超声波清洗机 15L Ultrasonic cleaning machine	M.UC.615HD	360W			15L	330x300x150mm	360x330x330mm
8头22升超声波清洗机 22L Ultrasonic cleaning machine	M.UC.822HD	480W			22L	500x300x150mm	550x330x330mm
10头30升超声波清洗机 30L Ultrasonic cleaning machine	M.UC.1030HD	600W			30L	500x300x200mm	550x330x380mm

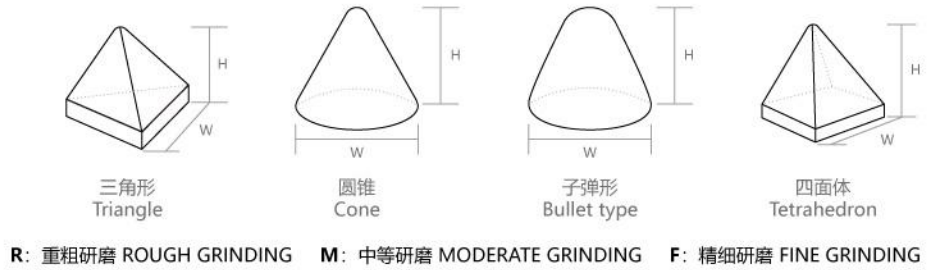
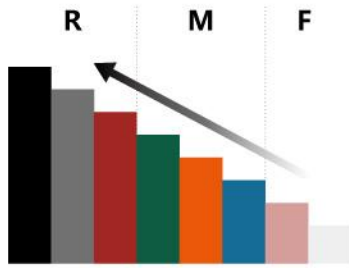

**SY** 塑质研磨石  
SY Plastic abrasive stone

型号 Model	尺寸 Size (W×H)	颜色 Color	形状 Shape
SYJ10H00	10×10mm	黑色 Black	三角形 Triangle
SYJ10A00	10×10mm	灰色 Grey	三角形 Triangle
SYJ10R00	10×10mm	红色 Red	三角形 Triangle
SYJ10G00	10×10mm	绿色 Green	三角形 Triangle
SYJ10O00	10×10mm	橙色 Orange	三角形 Triangle
SYJ10B00	10×10mm	蓝色 Blue	三角形 Triangle
SYJ10P00	10×10mm	粉红 Pink	三角形 Triangle
SYJ10W00	10×10mm	白色 White	三角形 Triangle
SYY10H00	10×10mm	黑色 Black	圆锥形 Cone
SYY10A00	10×10mm	灰色 Grey	圆锥形 Cone
SYY10R00	10×10mm	红色 Red	圆锥形 Cone
SYY10G00	10×10mm	绿色 Green	圆锥形 Cone
SYY10O00	10×10mm	橙色 Orange	圆锥形 Cone
SYY10B00	10×10mm	蓝色 Blue	圆锥形 Cone
SYY10P00	10×10mm	粉红 Pink	圆锥形 Cone
SYY10W00	10×10mm	白色 White	圆锥形 Cone



适用于软金属产品，如金、银、铜、铝等，工件刮痕少。

Suitable for soft metal products, such as gold, silver, copper, aluminum, etc., with fewer scratches on the workpiece.

**SC** 塑质研磨石  
SC Plastic abrasive stone

型号 Model	尺寸 Size (W×H)	颜色 Color	形状 Shape
SCJ10H00	10×10mm	黑色 Black	三角形 Triangle
SCJ10A00	10×10mm	灰色 Grey	三角形 Triangle
SCJ10R00	10×10mm	红色 Red	三角形 Triangle
SCJ10G00	10×10mm	绿色 Green	三角形 Triangle
SCJ10O00	10×10mm	橙色 Orange	三角形 Triangle
SCJ10B00	10×10mm	蓝色 Blue	三角形 Triangle
SCJ10P00	10×10mm	粉红 Pink	三角形 Triangle
SCY10H00	10×10mm	黑色 Black	圆锥形 Cone
SCY10A00	10×10mm	灰色 Grey	圆锥形 Cone
SCY10R00	10×10mm	红色 Red	圆锥形 Cone
SCY10G00	10×10mm	绿色 Green	圆锥形 Cone
SCY10O00	10×10mm	橙色 Orange	圆锥形 Cone
SCY10B00	10×10mm	蓝色 Blue	圆锥形 Cone
SCY10P00	10×10mm	粉红 Pink	圆锥形 Cone



适用于硬金属产品，如钛、不锈钢、铁等，切削力强；不能用于镶嵌钻石的工件。

Suitable for hard metal products such as titanium, stainless steel, and iron, with strong cutting force, not applicable for workpieces with stone setting.

### AO 塑质研磨石 AO Plastic abrasive stone

型号 Model	尺寸 Size (W×H)	颜色 Color	形状 Shape	用途 Function
AOJ10H00	10×10mm	黑色 Black	三角形 Triangle	 <p>适用于非金属产品，如亚克力、宝石等；磨光效果好。</p> <p>Suitable for non-metallic products such as acrylic and gemstones, provides excellent polishing results.</p>
AOJ10A00	10×10mm	灰色 Grey	三角形 Triangle	
AOJ10R00	10×10mm	红色 Red	三角形 Triangle	
AOJ10G00	10×10mm	绿色 Green	三角形 Triangle	
AOJ10O00	10×10mm	橙色 Orange	三角形 Triangle	
AOJ10B00	10×10mm	蓝色 Blue	三角形 Triangle	
AOJ10P00	10×10mm	粉红 Pink	三角形 Triangle	
AOY10H00	10×10mm	黑色 Black	圆锥形 Cone	
AOY10A00	10×10mm	灰色 Grey	圆锥形 Cone	
AOY10R00	10×10mm	红色 Red	圆锥形 Cone	
AOY10G00	10×10mm	绿色 Green	圆锥形 Cone	
AOY10O00	10×10mm	橙色 Orange	圆锥形 Cone	
AOY10B00	10×10mm	蓝色 Blue	圆锥形 Cone	
AOY10P00	10×10mm	粉红 Pink	圆锥形 Cone	

### ZO 塑质研磨石 ZO Plastic abrasive stone

型号 Model	尺寸 Size (W×H)	颜色 Color	形状 Shape	用途 Function
ZOJ10H00	10×10mm	黑色 Black	三角形 Triangle	 <p>适用于硬金属产品，如钛、不锈钢、铁等，磨光效果比AO系列研磨石好。</p> <p>Suitable for hard metal products such as titanium, stainless steel, and iron etc., polishing effect is better than the AO series.</p>
ZOJ10A00	10×10mm	灰色 Grey	三角形 Triangle	
ZOJ10R00	10×10mm	红色 Red	三角形 Triangle	
ZOJ10G00	10×10mm	绿色 Green	三角形 Triangle	
ZOJ10O00	10×10mm	橙色 Orange	三角形 Triangle	
ZOJ10B00	10×10mm	蓝色 Blue	三角形 Triangle	
ZOJ10P00	10×10mm	粉红 Pink	三角形 Triangle	
ZOY10H00	10×10mm	黑色 Black	圆锥形 Cone	
ZOY10A00	10×10mm	灰色 Grey	圆锥形 Cone	
ZOY10R00	10×10mm	红色 Red	圆锥形 Cone	
ZOY10G00	10×10mm	绿色 Green	圆锥形 Cone	
ZOY10O00	10×10mm	橙色 Orange	圆锥形 Cone	
ZOY10B00	10×10mm	蓝色 Blue	圆锥形 Cone	
ZOY10P00	10×10mm	粉红 Pink	圆锥形 Cone	

### 粗磨胶石 Coarse polishing abrasive stone

代码 Model	尺寸 Size	颜色 Color	形状 Shape
T.PW.10AGO320	10×10mm	红色 Red	三角形 Triangle
T.PW.10BGO320	10×10mm	红色 Red	圆锥形 Cone



### 中磨胶石 Medium polishing abrasive stone

代码 Model	尺寸 Size	颜色 Color	形状 Shape
T.PW.10AJO400	10×10mm	绿色 Green	三角形 Triangle
T.PW.10BJO400	10×10mm	绿色 Green	圆锥形 Cone
T.PW.BSJ010-ZA	10×10mm	蓝色 Blue	三角形 Triangle
T.PW.BYZ010-ZA	10×10mm	蓝色 Blue	圆锥形 Cone
T.PW.ASJ010-ZB	10×10mm	灰色 Grey	三角形 Triangle
T.PW.AYZ010-ZB	10×10mm	灰色 Grey	圆锥形 Cone

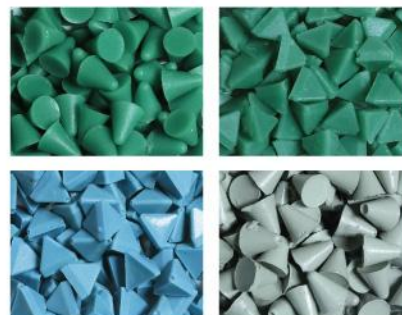

## 细磨胶石 Fine polishing abrasive stone

代码 Model	尺寸 Size	颜色 Color	形状 Shape
T.PW.GSJ010-XB	10×10mm	绿色 Green	三角形 Triangle
T.PW.GYZ010-XB	10×10mm	绿色 Green	圆锥形 Cone
T.PW.YSJ010-XB	10×10mm	黄色 Yellow	三角形 Triangle
T.PW.YYZ010-XB	10×10mm	黄色 Yellow	圆锥形 Cone



## 塑质研磨石 Plastic abrasive stone

代码 Model	尺寸 Size	颜色 Color	形状 Shape	粗细度 Fineness
T.PW.SSJZ010-P180#	10×10mm	浅红色 Light red	金字塔 Pyramid	180#
T.PW.SSYZ010-P180#	10×10mm	浅红色 Light red	圆锥形 Cone	180#
T.PW.SSJZ010-G240#	10×10mm	青绿色 Green	金字塔 Pyramid	240#
T.PW.SSYZ010-G240#	10×10mm	青绿色 Green	圆锥形 Cone	240#
T.PW.SSJZ010-G400#	10×10mm	青绿色 Green	金字塔 Pyramid	400#
T.PW.SSYZ010-G400#	10×10mm	青绿色 Green	圆锥形 Cone	400#
T.PW.SSJZ010-O600#-B	10×10mm	橙色 Orange	金字塔 Pyramid	600#
T.PW.SSYZ010-O600#-B	10×10mm	橙色 Orange	圆锥形 Cone	600#
T.PW.SSJZ010-Y600#	10×10mm	黄色 Yellow	金字塔 Pyramid	600#
T.PW.SSYZ010-Y600#	10×10mm	黄色 Yellow	圆锥形 Cone	600#
T.PW.SSJZ010-B800#	10×10mm	蓝色 Blue	金字塔 Pyramid	800#
T.PW.SSYZ010-B800#	10×10mm	蓝色 Blue	圆锥形 Cone	800#
T.PW.SSJZ010-P800#	10×10mm	粉红色 Pink	金字塔 Pyramid	800#
T.PW.SSYZ010-W1000#	10×10mm	白色 White	圆锥形 Cone	1000#
T.PW.SSJZ010-W1000#	10×12mm	白色 White	金字塔 Pyramid	1000#
T.PW.SSJZ010-P1200#	10×10mm	粉红色 Pink	金字塔 Pyramid	1200#
T.PW.SSYZ010-P1200#	10×10mm	粉红色 Pink	圆锥形 Cone	1200#
T.PW.SSJZ010-P1200#-B	10×10mm	粉红色 Pink	金字塔 Pyramid	1200#
T.PW.SSYZ010-P1200#-B	10×10mm	粉红色 Pink	圆锥形 Cone	1200#
T.PW.SSYZ012-P800#-H	12×12mm	粉红色 Pink	圆锥形 Cone	800#
T.PW.SSYZ012-P1200#-H	12×12mm	粉红色 Pink	圆锥形 Cone	1200#
T.PW.SSYZ012-P800#-H-YS	-	粉色 Pink	不定形 Shapeless	800#
T.PW.SSYZ012-P1200#-H-YS	-	粉色 Pink	不定形 Shapeless	1200#
T.PW.SSYZ010-P1000#-D	10×10mm	粉红色 Pink	圆锥形 Cone	1000#
T.PW.SSYZ015-P1000#-D	15×15mm	粉红色 Pink	圆锥形 Cone	1000#
T.PW.SSYZ010-G400#-YS	-	青绿色 Green	不定形 Shapeless	400#



## 耐磨胶石 Wear-resistant plastic abrasive stone

代码 Model	尺寸 Size	颜色 Color	形状 Shape	粗细度 Fineness
T.PW.PL-G600#-YS	-	绿色 Green	不定形 Shapeless	600#
T.PW.PLJZ010-600#	10×10mm	浅绿色 light green	金字塔 Pyramid	600#
T.PW.PLYZ010-600#	10×10mm	浅绿色 light green	圆锥形 Cone	600#
T.PW.SSJZ010-P320#-Y	10×10mm	红色 Red	三角形 Triangle	320#
T.PW.SSYZ010-P320#-Y	10×10mm	红色 Red	圆锥形 Cone	320#



## 首饰精磨胶石 Fine polishing plastic abrasive stone

代码 Model	尺寸 Size	颜色 Color	形状 Shape	粗细度 Fineness
T.PW.PSJZ001-1300#-Y	10×10mm	粉红色 Pink	金字塔 Pyramid	1300#
T.PW.PSYZ001-1300#-Y	10×10mm	粉红色 Pink	圆锥形 Cone	1300#
T.PW.PSYZ001-1300#-Y-YS	-	粉色 Pink	不定形 Shapeless	1300#



### 瓷质抛光珠 (高铝瓷)

#### Ceramic polishing beads (high alumina porcelain)

代码 Model	尺寸 Size	颜色 Color	形状 Shape	切削力 Cutting force
T.PW.SCSJ0303	3×3mm	白色 White	三角形 Triangle	幼磨 Fine grinding force
T.PW.SCSJ0404	4×4mm	白色 White	三角形 Triangle	幼磨 Fine grinding force
T.PW.SCSJ0505	5×5mm	白色 White	三角形 Triangle	幼磨 Fine grinding force
T.PW.SCSJ0606	6×6mm	白色 White	三角形 Triangle	幼磨 Fine grinding force
T.PW.SCYZ01303	1.3×3mm	白色 White	圆柱形 Cylinder	幼磨 Fine grinding force
T.PW.SCYZ01303-L	1.3×3mm	白色 White	圆柱形 Cylinder	幼磨 Fine grinding force
T.PW.SCYZ01505	1.5×5mm	白色 White	圆柱形 Cylinder	幼磨 Fine grinding force
T.PW.SCYZ01505-L	1.5×5mm	白色 White	圆柱形 Cylinder	幼磨 Fine grinding force
T.PW.SCYZ0306-L	3×6mm	白色 White	圆柱形 Cylinder	幼磨 Fine grinding force
T.PW.SCYZ0516	5×16mm	白色 White	圆柱形 Cylinder	幼磨 Fine grinding force
T.PW.SCYZ0723	7×23mm	白色 White	圆柱形 Cylinder	幼磨 Fine grinding force
T.PW.SCYZ0204	2×4mm	白色 White	斜圆柱形 Angle cut cylinder	幼磨 Fine grinding force
T.PW.SCYZ0306	3×6mm	白色 White	斜圆柱形 Angle cut cylinder	幼磨 Fine grinding force
T.PW.SCYZ0408	4×8mm	白色 White	斜圆柱形 Angle cut cylinder	幼磨 Fine grinding force
T.PW.SCYZ0510	5×10mm	白色 White	斜圆柱形 Angle cut cylinder	幼磨 Fine grinding force
T.PW.SCYQ002-W	Φ2mm	白色 White	圆球形 Balls	幼磨 Fine grinding force
T.PW.SCYQ003-W	Φ3mm	白色 White	圆球形 Balls	幼磨 Fine grinding force
T.PW.SCYQ004-W	Φ4mm	白色 White	圆球形 Balls	幼磨 Fine grinding force
T.PW.SCYQ005-W	Φ5mm	白色 White	圆球形 Balls	幼磨 Fine grinding force
T.PW.SCYQ006-W	Φ6mm	白色 White	圆球形 Balls	幼磨 Fine grinding force
T.PW.SCYQ008-W	Φ8mm	白色 White	圆球形 Balls	幼磨 Fine grinding force
T.PW.SCYQ010-W	Φ10mm	白色 White	圆球形 Balls	幼磨 Fine grinding force
T.PW.SCYQ002-Y	Φ2mm	姜黄色 Ginger yellow	圆球形 Balls	幼磨 Fine grinding force



### 高分珠

#### High zirconium polishing beads

代码 Model	尺寸 Size	材质 Material	颜色 Color	形状 Shape	切削力 Cutting force
T.PW.GF010	Φ1.0mm	锆 Zirconium	白色 White	圆球形 Balls	零 Zero grinding force
T.PW.GF015	Φ1.5mm	锆 Zirconium	白色 White	圆球形 Balls	零 Zero grinding force
T.PW.GF020	Φ2.0mm	锆 Zirconium	白色 White	圆球形 Balls	零 Zero grinding force
T.PW.GF030	Φ3.0mm	锆 Zirconium	白色 White	圆球形 Balls	零 Zero grinding force
T.PW.GF040	Φ4.0mm	锆 Zirconium	白色 White	圆球形 Balls	零 Zero grinding force

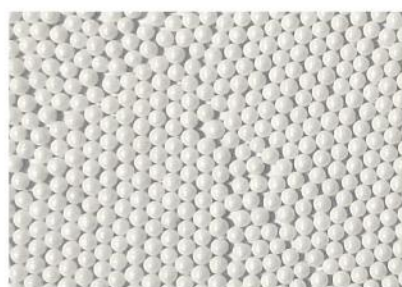

### 抛光锆珠

#### Polished zirconium beads

代码 Model	尺寸 Size	材质 Material	颜色 Color	形状 Shape	切削力 Cutting force
T.PW.GZ001A-GS	Φ1.0mm	锆 Zirconium	白色 White	圆球形 Balls	零 Zero grinding force
T.PW.GZ015A-GS	Φ1.5mm	锆 Zirconium	白色 White	圆球形 Balls	零 Zero grinding force
T.PW.GZ002A-GS	Φ2.0mm	锆 Zirconium	白色 White	圆球形 Balls	零 Zero grinding force
T.PW.GZ003A-GS	Φ3.0mm	锆 Zirconium	白色 White	圆球形 Balls	零 Zero grinding force



## 复合抛光珠 Mixed polished beads

代码 Model	尺寸 Size	材质 Material	颜色 Color	形状 Shape	切削力 Cutting force
T.PW.GZ001-FH-501	Φ1mm	锆 Zirconium	白色 White	圆球形 Balls	零 Zero grinding force
T.PW.GZ015-FH-501	Φ1.5mm	锆 Zirconium	白色 White	圆球形 Balls	零 Zero grinding force
T.PW.GZ002-FH-501	Φ2mm	锆 Zirconium	白色 White	圆球形 Balls	零 Zero grinding force
T.PW.GZ003-FH-501	Φ3mm	锆 Zirconium	白色 White	圆球形 Balls	零 Zero grinding force



## 日本扁豆 Japan flat beans

代码 Model	尺寸 Size	颜色 Color	形状 Shape	切削力 Cutting force
T.PW.BD02-Y	Φ2mm	黄色 Yellow	不定形 Shapeless	零 Zero grinding force
T.PW.BD03-Y	Φ3mm	黄色 Yellow	不定形 Shapeless	零 Zero grinding force
T.PW.BD04-Y	Φ4mm	黄色 Yellow	不定形 Shapeless	零 Zero grinding force
T.PW.BD05-Y	Φ5mm	黄色 Yellow	不定形 Shapeless	零 Zero grinding force



## 抛光黄珠 Yellow grinding beads

代码 Model	尺寸 Size	颜色 Color	形状 Shape	切削力 Cutting force
T.PW.00059	Φ2mm	黄色 Yellow	圆球形 Balls	零 Zero grinding force
T.PW.00062	Φ3mm	黄色 Yellow	圆球形 Balls	零 Zero grinding force
T.PW.00060	Φ4mm	黄色 Yellow	圆球形 Balls	零 Zero grinding force
T.PW.00064	Φ5mm	黄色 Yellow	圆球形 Balls	零 Zero grinding force



## 瓷质抛光珠 (高频瓷) Ceramic polishing beads (high frequency porcelain)

代码 Model	尺寸 Size	颜色 Color	形状 Shape	切削力 Cutting force
T.PW.SCYZ01303	1.3×3mm	白色 White	圆柱形 Cylinder	微 Micro grinding force
T.PW.SCYZ01505	1.5×5mm	白色 White	圆柱形 Cylinder	微 Micro grinding force
T.PW.SCYQ002-Y	Φ2mm	白色 White	圆球形 Balls	微 Micro grinding force
T.PW.SCYQ003-G	Φ3mm	白色 White	圆球形 Balls	微 Micro grinding force



## 干式抛光介质-玉米芯 Dry polishing media (corn cob)

代码 Model	尺寸 Size	材质 Material	粗细度 Fineness
T.PW.C4-Y	5-6mm	原料 Raw materials	4#
T.PW.C5-Y	4-5mm	原料 Raw materials	5#
T.PW.C6-Y	3.5-4mm	原料 Raw materials	6#
T.PW.C8-Y	2.8-3.5mm	原料 Raw materials	8#
T.PW.C10-Y	2.2-2.8mm	原料 Raw materials	10#
T.PW.C12-Y	2-2.2mm	原料 Raw materials	12#
T.PW.C4	5-6mm	开好料 Processed	4#
T.PW.C5	4-5mm	开好料 Processed	5#
T.PW.C6	3.5-4mm	开好料 Processed	6#
T.PW.C8	2.8-3.5mm	开好料 Processed	8#
T.PW.C10	2.2-2.8mm	开好料 Processed	10#
T.PW.C12	2-2.2mm	开好料 Processed	12#



### 干式抛光介质-核桃壳 Dry polishing media (walnut)

代码 Model	尺寸 Size	材质 Material	粗细度 Fineness
T.PW.GHTW3-Y	6-8mm	原料 Raw materials	3#
T.PW.GHTW4-Y	5-6mm	原料 Raw materials	4#
T.PW.GHTW5-Y	4-5mm	原料 Raw materials	5#
T.PW.GHTW6-Y	3-4mm	原料 Raw materials	6#
T.PW.GHTW8-Y	2.8-3.5mm	原料 Raw materials	8#
T.PW.GHTW10-Y	2.2-2.8mm	原料 Raw materials	10#
T.PW.GHTW12-Y	2-2.2mm	原料 Raw materials	12#
T.PW.GHTW14-Y	1.6-2mm	原料 Raw materials	14#
T.PW.GHTW20-Y	0.8-1mm	原料 Raw materials	20#
T.PW.GHTW24-Y	0.6-0.8mm	原料 Raw materials	24#
T.PW.GHTW36-Y	0.4-0.5mm	原料 Raw materials	36#
T.PW.GHTW3	6-8mm	开好料 Processed	3#
T.PW.GHTW4	5-6mm	开好料 Processed	4#
T.PW.GHTW5	4-5mm	开好料 Processed	5#
T.PW.GHTW6	3-4mm	开好料 Processed	6#
T.PW.GHTW8	2.8-3.5mm	开好料 Processed	8#
T.PW.GHTW10	2.2-2.8mm	开好料 Processed	10#
T.PW.GHTW12	2-2.2mm	开好料 Processed	12#
T.PW.GHTW14	1.6-2mm	开好料 Processed	14#
T.PW.GHTW20	0.8-1mm	开好料 Processed	20#
T.PW.GHTW24	0.6-0.8mm	开好料 Processed	24#
T.PW.GHTW36	0.4-0.5mm	开好料 Processed	36#



### 干式抛光介质-木粒 Dry polishing media(wood chips)

代码 Model	尺寸 Size	形状 Shape	粗细度 Fineness	包装 Package
T.PW.GMLY004	33×12×12mm	菱形 Rhombus	粗抛 Primary polishing	30KG/包/Pack
T.PW.GMLY005	27×8×8mm	菱形 Rhombus	中抛 Medium polishing	25KG/包/Pack
T.PW.GMLS004	4×4×4mm	方形 Square	精抛 Fine polishing	25KG/包/Pack



混合抛光料  
Mixed polishing compound  
T.PW.PGG66



12#混合抛光料 (含锆珠)  
12# mixed polishing compound (containing zirconium beads)  
T.PW.PGG67

钢珠  
Steel ball

代码 Model	尺寸 Size	形状 Shape	材质 Material
T.PW.SGY001-201	Φ1mm	圆球形 Balls	201
T.PW.SGY002-201	Φ2mm	圆球形 Balls	201
T.PW.SGY003-201	Φ3mm	圆球形 Balls	201
T.PW.SGY004-201	Φ4mm	圆球形 Balls	201
T.PW.SGY005-201	Φ5mm	圆球形 Balls	201
T.PW.SGY006-201	Φ6mm	圆球形 Balls	201
T.PW.SGY007-201	Φ7mm	圆球形 Balls	201
T.PW.SGY008-201	Φ8mm	圆球形 Balls	201
T.PW.SGY009-201	Φ9mm	圆球形 Balls	201
T.PW.SGY010-201	Φ10mm	圆球形 Balls	201
T.PW.SGY001-304	Φ1mm	圆球形 Balls	304
T.PW.SGY002-304	Φ2mm	圆球形 Balls	304
T.PW.SGY003-304	Φ3mm	圆球形 Balls	304
T.PW.SGY004-304	Φ4mm	圆球形 Balls	304
T.PW.SGY005-304	Φ5mm	圆球形 Balls	304
T.PW.SGY006-304	Φ6mm	圆球形 Balls	304
T.PW.SGY007-304	Φ7mm	圆球形 Balls	304
T.PW.SGY008-304	Φ8mm	圆球形 Balls	304
T.PW.SGY009-304	Φ9mm	圆球形 Balls	304
T.PW.SGY010-304	Φ10mm	圆球形 Balls	304
T.PW.SGY001-316	Φ1mm	圆球形 Balls	316
T.PW.SGY002-316	Φ2mm	圆球形 Balls	316
T.PW.SGY003-316	Φ3mm	圆球形 Balls	316
T.PW.SGY004-316	Φ4mm	圆球形 Balls	316
T.PW.SGY005-316	Φ5mm	圆球形 Balls	316



飞碟钢珠  
Ball cone steel tumbling media

代码 Model	尺寸 Size	材质 Material	形状 Shape
T.PW.SGF24-201	2.5×4mm	201	飞碟 Flying saucer
T.PW.SGF35-201	3.5×5.5mm	201	飞碟 Flying saucer
T.PW.SGF47-201	4.5×7mm	201	飞碟 Flying saucer
T.PW.SGF57-201	5×7mm	201	飞碟 Flying saucer
T.PW.SGF812-201	8×12mm	201	飞碟 Flying saucer



钢制抛光介质  
Other shape steel polishing media

代码 Model	尺寸 Size	材质 Material	形状 Shape
T.PW.SGJ27-201	2×7.5mm	201	双头尖 Double pointed head
T.PW.SGYZ24-201	2×4mm	201	圆柱形 Cylinder
T.PW.SGYZ28-201	2×8mm	201	圆柱形 Cylinder
T.PW.SGTY34-204	3×4mm	201	旦形 Oval





磁力抛光针  
Magnetic polishing pins



代码 Model	尺寸 Size	形状 Shape
T.MP.P2050	Φ0.2×L5mm	平头 Flat head
T.MP.P3050	Φ0.3×L5mm	平头 Flat head
T.MP.P4050	Φ0.4×L5mm	平头 Flat head
T.MP.P5050	Φ0.5×L5mm	平头 Flat head
T.MP.P6050	Φ0.6×L5mm	平头 Flat head
T.MP.P8050	Φ0.8×L5mm	平头 Flat head
T.MP.P2050-A	Φ0.2×L5mm	平头 Flat head
T.MP.P3050-A	Φ0.3×L5mm	平头 Flat head
T.MP.P4050-A	Φ0.4×L5mm	平头 Flat head
T.MP.P5050-A	Φ0.5×L5mm	平头 Flat head
T.MP.P6050-A	Φ0.6×L5mm	平头 Flat head
T.MP.Y2050	Φ0.2×L5mm	圆头 Round head
T.MP.Y3050	Φ0.3×L5mm	圆头 Round head
T.MP.Y4050	Φ0.4×L5mm	圆头 Round head
T.MP.Y5050	Φ0.5×L5mm	圆头 Round head
T.MP.Y6050	Φ0.6×L5mm	圆头 Round head
T.MP.Y2050-A	Φ0.2×L5mm	圆头 Round head
T.MP.Y3050-A	Φ0.3×L5mm	圆头 Round head
T.MP.Y4050-A	Φ0.4×L5mm	圆头 Round head
T.MP.Y5050-A	Φ0.5×L5mm	圆头 Round head
T.MP.Y6050-A	Φ0.6×L5mm	圆头 Round head
T.MP.L040606	0.4×6×6mm	L型 L Type
T.MP.L080606	0.8×6×6mm	L型 L Type
T.MP.L050606	0.5×6×6mm	L型 L Type
T.MP.L051212	0.5×12×12mm	L型 L Type
T.MP.L061010	0.6×10×10mm	L型 L Type
T.MP.L080808	0.8×8×8mm	L型 L Type
T.MP.P305050	0.5×0.5×0.5mm	带圈异形 Circled heterotypic
T.MP.P505050	0.3×5×5mm	带圈异形 Circled heterotypic
T.MP.V050505	0.5×5×5mm	V型 V Type
T.MP.V030505	0.3×5×5mm	V型 V Type





**电解抛光液**  
Electrolytic polishing fluid

**用途:** 适用于金、银、铜、不锈钢材质工件的电解抛光，可以对工件进行高亮度的镜面抛光且光泽保持时间长。

**Function:** Suitable for electrolytic polishing of work-pieces made of gold, silver, copper, stainless steel, It can perform high-brightness mirror polishing on work-pieces and the gloss can be maintained for a long time.

T.P.PGG76 (Au) / T.P.PGG77 (Ag) / T.P.PGG78 (Cu)

**磁力抛光液**  
Magnetic polishing solution

**用途:** 去氧化皮、清洁石膏粉，隙位打亮，配合相应的磁力抛光针及磁力抛光机。

**Function:** It is used to remove scale, clean gypsum powder, and brighten gaps. It is used with corresponding magnetic polishing needles and magnetic polishing machines.

T.PW.PGG27

**塑质研磨膏**  
Polishing paste

**用途:** 金、银、铜，不锈钢，钛合金、玉石等工件表面研磨处理，提高工件表面平滑度。

**Function:** Surface grinding of gold ,silver, copper, stainless steel, titanium alloy, jade and other workpieces can Improve the smoothness of the workpiece surface.

粗磨 Rough grinding T.PW.PGG60    中磨 Middle grinding T.PW.PGG61    精磨 Fine polishing T.PW.PGG62

**光亮剂**  
Brightener

**用途:** 金、银、铜，不锈钢，钛合金、玉石等工件表面抛光处理，提高工件表面光洁度和光亮度。

**Function:** To polish gold, silver, copper, stainless steel, titanium, jade and other workpiece surface, Improve brightness of polishing workpieces.

混合光亮剂 Brightener T.PW.PGG03A    混合光亮剂 Brightener T.PW.PGG03A-B    混合光亮剂 Brightener T.PW.PGG09A-B    进口光亮剂 Imported brightener T.PW.PGG09A

**抛光粉**  
Polishing compound

**用途:** 在干式滚桶研磨过程中，后期（在工件即将磨透沙纸痕，出机前2小时左右），加入适量的抛光粉，可以增强工件光亮度以及嫩滑度。

**Function:** While in the dry polishing process, put some polishing powder into the work piece (before 2 hours before it stop polishing) to achieve better shiny and smooth surface.

T.PW.PGG36-4 / T.PW.PGG36-6 / T.PW.PGG42

**开料油**  
Polishing oil for media

**用途:** 让核桃壳料与研磨膏更好粘在一起。

**Function:** It is for the walnut media and polishing paste stick together better.

T.PW.PGG23

**除蜡水**  
Dewaxing water

**使用方法:** 取本品加水，浓度（4-5%）温度（70-90℃）条件下；佩戴安全防护劳保用品进行工件清洗操作。

**Usage method:** take this product and add water, potency(4-5%), temperature (70-90℃), wear safety protection equipment for operation.

H.WR.00008-25 / H.WR.00006 / H.WR.00010 / H.WR.B-810

**混合膏**  
Polishing mixed

**用途:** 金、银、铜，不锈钢，钛合金、玉石等工件表面研磨处理，提高工件表面平滑度。

**Function:** Surface grinding of gold ,silver, copper, stainless steel, titanium alloy, jade and other workpieces can Improve the smoothness of the workpiece surface.

T.PW.PGG45

**研磨液**  
Grinding fluid

**用途:** 提高磨削效率，减少磨具的磨损，对工件有保护及润滑作用。

**Function:** Improve polishing efficiency, reduce wear and tear on the surface, It has protection and lubrication function to the workpiece.

T.PW.PG003A

**研磨粉**  
Polishing powder

**用途:** 在干式滚桶研磨过程中，前期用研磨膏调好料之后，加入适量的研磨粉，能大幅提升切削力，缩短研磨的时间，使得工件磨得更平整。

**Function:** In the dry drum grinding process, after adjusting the material with the grinding paste in the early stage, adding an appropriate amount of grinding powder can greatly increase the cutting force, shorten the grinding time, and make the workpiece more smooth.

TT.PW.PGG73

**研磨膏**  
Polishing paste

**用途:** 金、银、铜，不锈钢，钛合金、玉石等工件表面研磨处理，提高工件表面平滑度。

**Function:** Surface grinding of gold ,silver, copper, stainless steel, titanium alloy, jade and other workpieces can Improve the smoothness of the workpiece surface.

精光 Fine polishing T.PW.PGG35    精磨 Fine polishing T.PW.PGG21C-1    细磨 Finer grinding T.PW.PGG75

中磨 Giddle grinding T.PW.PGG21A    粗磨 Gough grinding TT.PW.PGG73    粗磨 Gough grinding T.PW.PGG74

**进口研磨膏**  
Import polishing paste

**用途:** 金、银、铜，不锈钢，钛合金、玉石等工件表面研磨处理，提高工件表面平滑度。

**Function:** Surface grinding of gold ,silver, copper, stainless steel, titanium alloy, jade and other workpieces can Improve the smoothness of the workpiece surface.

粗磨 Gough grinding T.PW.PGG53    中磨 Giddle grinding T.PW.PGG48

中磨 Giddle grinding T.PW.PGG49    镜光 Fine polishing T.PW.PGG50

抛光蜡  
Polishing wax

**BBB白蜡**  
BBB white compound  
T.PW.PGL06  
174×68×46mm  
900g/条/Bar



**BBB白蜡**  
BBB white compound  
T.PW.PGL06-B  
170×60×40mm  
770g/条/Bar 500#



**BBB青蜡**  
BBB green compound  
T.PW.PGL07  
174×68×46mm  
900g/条/Bar



**BBB青蜡**  
BBB green compound  
T.PW.PGL07-B  
170×60×40mm  
880g/条/Bar 600#



**555大青蜡**  
555 Green compound  
T.PW.PGL41  
150×60×42mm  
750g/条/Bar 400#



**555青蜡**  
555 Green compound  
T.PW.PGL26  
115×60×35mm  
430g/条/Bar 800#



**555白蜡**  
555 White compound  
T.PW.PGL27  
150×60×42mm  
660g/条/Bar 400#



**555黄蜡**  
555 Yellow compound  
T.PW.PGL16  
170×60×50mm  
750g/条/Bar 400#



**MEGA 5#小白蜡**  
5# White compound  
T.PW.PGL57  
150×50×30mm  
350g/条/Bar



**MEGA铁蜡**  
Iron compound  
T.PW.PGL53  
205×55×40mm  
850g/条/Bar



**MEGA 8#青蜡**  
Green compound  
T.PW.PGL54  
205×55×40mm  
850g/条/Bar



**MEGA 蓝蜡**  
Blue compound  
T.PW.PGL56  
205×55×40mm  
920kg/条/Bar



**闪光3#绿蜡**  
3# Green compound  
T.T.PW.PGL47  
120×38×50mm  
500g/条/Bar 3000#



**闪光3#白蜡**  
3# White compound  
T.PW.PGL36  
200×55×41mm  
900g/条/Bar 1200#



**闪光1#白蜡**  
1# White compound  
T.PW.PGL37-A  
200×55×41mm  
900g/条/Bar 800#



**闪光1#紫蜡**  
1# Purple compound  
T.PW.PGL50  
200×55×41mm  
900g/条/Bar 1000#



**闪光4#绿蜡**  
4# Green compound  
T.PW.PGL51  
200×55×41mm  
800g/条/Bar



**1#黄蜡**  
1# Yellow compound  
T.PW.PGL49  
170×60×45mm  
800g/条/Bar 200#



**3#黄蜡**  
3# yellow compound  
T.PW.PGL43  
170×44mm  
740g/条/Bar 300#



**5#紫蜡**  
5# Purple compound  
T.PW.PGL46  
200×55×41mm  
900g/条/Bar 500#



**日本蓝蜡**  
Japan blue compound  
T.PW.PGL12  
130×51×40mm  
500kg/条/Bar



**英国红蜡**  
England red compound  
T.PW.PGL14  
440g/条/Bar



**进口黄蜡**  
Import yellow compound  
T.PW.PGL39  
150g/条/Bar



**进口黄蜡**  
Import yellow compound  
T.PW.PGL40  
150g/条/Bar



**AT黄蜡**  
Yellow compound  
T.PW.PGL17  
192×42×40mm  
750g/条/Bar 200#, 325#, 1000#



**AT紫蜡**  
Purple compound  
T.PW.PGL17  
192×42×40mm  
750g/条/Bar



**AUG绿蜡**  
AUG green compound  
T.PW.PGL09  
205×55×45mm  
880g/条/Bar 8000#



**AUG白蜡**  
AUG white compound  
T.PW.PGL08  
205×55×45mm  
830g/条/Bar 800#-1200#



**D-36蓝蜡**  
Blue compound  
T.PW.PGL13  
130×55×45mm  
500g/条/Bar 12000#-15000#



**KOVO-HD青蜡**  
Green compound  
T.PW.PGL25  
122×46×30mm  
410g/条/Bar 800#



**精光小蓝蜡**  
Blue compound  
T.PW.PGL55  
150×50×30mm  
350g/条/Bar



**MEGA紫蜡**  
Purple compound  
T.PW.PGL52  
205×55×40mm  
920g/条/Bar



**PME青蜡**  
PME Green compound  
T.PW.PGL03  
220×47mm  
850g/条/Bar



**PME白蜡**  
PME white compound  
TT.PW.PGL02  
220×47mm  
900kg/条/Bar



**G105B大青蜡**  
Green compound  
T.PW.PGL45  
204×52mm  
920g/条/Bar 1000#



### 硅胶磨头 Polyster polishing bits

代码 Model	尺寸 Size	砂度 Sandness	转数 Rotating of number
A T.BW.MTSK404-VC	Φ4×12mm	特粗 Extra thick	10000-20000/Min
B T.BW.MTSK406-VC	Φ6×16mm	特粗 Extra thick	10000-20000/Min
C T.BW.MTSK410-VC	Φ10×20mm	特粗 Extra thick	10000-20000/Min
D T.BW.MTSK610-VC	Φ10×24mm	特粗 Extra thick	10000-20000/Min
E T.BW.MTSK810-VC	Φ10×17mm	特粗 Extra thick	10000-20000/Min

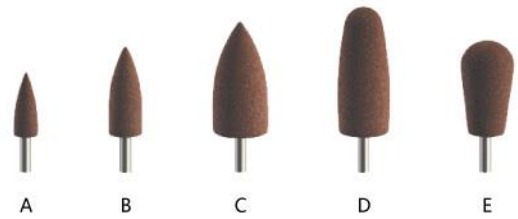

包装 Package: 100 Pcs/box

### 硅胶磨头 Polyster polishing bits

代码 Model	尺寸 Size	砂度 Sandness	转数 Rotating of number
A T.BW.MTSK404-C	Φ4×12mm	粗 Thick	10000-20000/Min
B T.BW.MTSK406-C	Φ6×16mm	粗 Thick	10000-20000/Min
C T.BW.MTSK410-C	Φ10×20mm	粗 Thick	10000-20000/Min
D T.BW.MTSK610-C	Φ10×24mm	粗 Thick	10000-20000/Min
E T.BW.MTSK810-C	Φ10×17mm	粗 Thick	10000-20000/Min



包装 Package: 100 Pcs/box

### 硅胶磨头 Polyster polishing bits

代码 Model	尺寸 Size	砂度 Sandness	转数 Rotating of number
A T.BW.MTSK404-M	Φ4×12mm	中粗 Medium thick	10000-15000/Min
B T.BW.MTSK406-M	Φ6×16mm	中粗 Medium thick	10000-15000/Min
C T.BW.MTSK410-M	Φ10×20mm	中粗 Medium thick	10000-15000/Min
D T.BW.MTSK610-M	Φ10×24mm	中粗 Medium thick	10000-15000/Min
E T.BW.MTSK810-M	Φ10×17mm	中粗 Medium thick	10000-15000/Min



包装 Package: 100 Pcs/box

### 硅胶磨头 Polyster polishing bits

代码 Model	尺寸 Size	砂度 Sandness	转数 Rotating of number
A T.BW.MTSK404-EF	Φ4×12mm	级细 Extra thin	8000-15000/Min
B T.BW.MTSK406-EF	Φ6×16mm	极细 Extra thin	8000-15000/Min
C T.BW.MTSK410-EF	Φ10×20mm	极细 Extra thin	8000-15000/Min
D T.BW.MTSK810-EF	Φ10×24mm	极细 Extra thin	8000-15000/Min
E T.BW.MTSK810-EF	Φ10×17mm	极细 Extra thin	8000-15000/Min

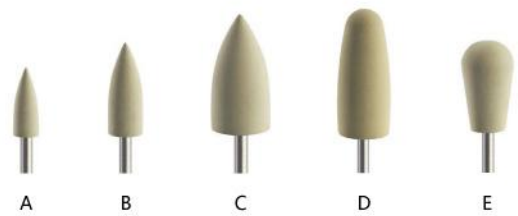

包装 Package: 100 Pcs/box

### 硅胶磨头 Polyster polishing bits

代码 Model	尺寸 Size	砂度 Sandness	转数 Rotating of number
A T.BW.MTSH406-C	Φ6×16mm	精 Sharp	15000-20000/Min
B T.BW.MTSH404-C-1	Φ4×12mm	精 Sharp	15000-20000/Min
C T.BW.MTSH704-C-1	Φ4×12mm	精 Sharp	15000-20000/Min
D T.BW.MTSH505-C	Φ5×12mm	精 Sharp	15000-20000/Min
E T.BW.MTSH312-C	Φ12×2mm	精 Sharp	15000-20000/Min
F T.BW.MTSH112-C	Φ12×2mm	精 Sharp	15000-20000/Min



包装 Package: 100 Pcs/box

硅胶磨头  
Polyster polishing bits

代码 Model	尺寸 Size	砂度 Sandness	转数 Rotating of number
A T.BW.MTSH406-M	Φ6×16mm	中粗 Medium thick	10000-15000/Min
B T.BW.MTSH404-M-1	Φ4×12mm	中粗 Medium thick	10000-15000/Min
C T.BW.MTSH704-M-1	Φ4×12mm	中粗 Medium thick	10000-15000/Min
D T.BW.MTSH505-M	Φ5×12mm	中粗 Medium thick	10000-15000/Min
E T.BW.MTSH312-M	Φ12×2mm	中粗 Medium thick	10000-15000/Min
F T.BW.MTSH112-M	Φ12×2mm	中粗 Medium thick	10000-15000/Min



包装 Package: 100 Pcs/box

硅胶磨头  
Polyster polishing bits

代码 Model	尺寸 Size	砂度 Sandness	转数 Rotating of number
A T.BW.MTSH406-F	Φ6×16mm	细 Thin	10000-12000/Min
B T.BW.MTSH404-F-1	Φ4×12mm	细 Thin	10000-12000/Min
C T.BW.MTSH704-F-1	Φ4×12mm	细 Thin	10000-12000/Min
D T.BW.MTSH505-F	Φ5×12mm	细 Thin	10000-12000/Min
E T.BW.MTSH312-F	Φ12×2mm	细 Thin	10000-12000/Min
F T.BW.MTSH502-F	Φ12×2mm	细 Thin	10000-12000/Min



包装 Package: 100 Pcs/box

硅胶磨头  
Polyster polishing bits

代码 Model	尺寸 Size	砂度 Sandness	转数 Rotating of number
A T.BW.MTSH403-C	Φ3×7mm	粗 Thick	10000-15000/Min
B T.BW.MTSH404-C	Φ4×12mm	粗 Thick	10000-15000/Min
C T.BW.MTSH405-C	Φ5×10mm	粗 Thick	10000-15000/Min
D T.BW.MTSH704-C	Φ4×11mm	粗 Thick	10000-15000/Min
E T.BW.MTSH906-C	Φ6×9.5mm	粗 Thick	10000-15000/Min
F T.BW.MTSH909-C	Φ9×9mm	粗 Thick	10000-15000/Min
G T.BW.MTSH310-C	Φ10×2mm	粗 Thick	10000-15000/Min
H T.BW.MTSH110-C	Φ10×1.8mm	粗 Thick	10000-15000/Min



包装 Package: 100 Pcs/box

硅胶磨头  
Polyster polishing bits

代码 Model	尺寸 Size	砂度 Sandness	转数 Rotating of number
A T.BW.MTSH403-M	Φ3×7mm	中粗 Medium thick	10000-12000/Min
B T.BW.MTSH404-M	Φ4×12mm	中粗 Medium thick	10000-12000/Min
C T.BW.MTSH405-M	Φ5×10mm	中粗 Medium thick	10000-12000/Min
D T.BW.MTSH704-M	Φ4×11mm	中粗 Medium thick	10000-12000/Min
E T.BW.MTSH906-M	Φ6×9.5mm	中粗 Medium thick	10000-12000/Min
F T.BW.MTSH909-M	Φ9×9.5mm	中粗 Medium thick	10000-12000/Min
G T.BW.MTSH310-M	Φ10×2mm	中粗 Medium thick	10000-12000/Min
H T.BW.MTSH110-M	Φ10×1.8mm	中粗 Medium thick	10000-12000/Min



包装 Package: 100 Pcs/box

### 硅胶磨头 Polyster polishing bits

代码 Model	尺寸 Size	砂度 Sandness	转数 Rotating of number
A T.BW.MTSH403-F	Φ3×7mm	细 Thin	10000-12000/Min
B T.BW.MTSH404-F	Φ4×12mm	细 Thin	10000-12000/Min
C T.BW.MTSH405-F	Φ5×10mm	细 Thin	10000-12000/Min
D T.BW.MTSH704-F	Φ4×11mm	细 Thin	10000-12000/Min
E T.BW.MTSH906-F	Φ6×9.5mm	细 Thin	10000-12000/Min
F T.BW.MTSH909-F	Φ9×9.5mm	细 Thin	10000-12000/Min
G T.BW.MTSH310-F	Φ10×2mm	细 Thin	10000-12000/Min
H T.BW.MTSH110-F	Φ10×1.8mm	细 Thin	10000-12000/Min



包装 Package: 100 Pcs/box

### 硅胶磨头 Polyster polishing bits

代码 Model	尺寸 Size	砂度 Sandness	转数 Rotating of number
A T.BW.MTSG403-VC	Φ3×7mm	特粗 Extra thick	10000-15000/Min
B T.BW.MTSG404-VC	Φ4×12mm	特粗 Extra thick	10000-15000/Min
C T.BW.MTSG405-VC	Φ5×10mm	特粗 Extra thick	10000-15000/Min
D T.BW.MTSG704-VC	Φ4×11mm	特粗 Extra thick	10000-15000/Min
E T.BW.MTSG310-VC	Φ10×2mm	特粗 Extra thick	10000-15000/Min
F T.BW.MTSG110-VC	Φ10×1.8mm	特粗 Extra thick	10000-15000/Min



包装 Package: 100 Pcs/box

### 硅胶磨头 Polyster polishing bits

代码 Model	尺寸 Size	砂度 Sandness	转数 Rotating of number
A T.BW.MTSG403-C	Φ3×7mm	粗 Thick	10000-15000/Min
B T.BW.MTSG404-C	Φ4×12mm	粗 Thick	10000-15000/Min
C T.BW.MTSG405-C	Φ5×10mm	粗 Thick	10000-15000/Min
D T.BW.MTSG704-C	Φ4×11mm	粗 Thick	10000-15000/Min
E T.BW.MTSG310-C	Φ10×2mm	粗 Thick	10000-15000/Min
F T.BW.MTSG110-C	Φ10×1.8mm	粗 Thick	10000-15000/Min



包装 Package: 100 Pcs/box

### 硅胶磨头 Polyster polishing bits

代码 Model	尺寸 Size	砂度 Sandness	转数 Rotating of number
A T.BW.MTSG403-F	Φ3×7mm	细 Thin	7000-12000/Min
B T.BW.MTSG404-F	Φ4×12mm	细 Thin	7000-12000/Min
C T.BW.MTSG405-F	Φ5×10mm	细 Thin	7000-12000/Min
D T.BW.MTSG704-F	Φ4×11mm	细 Thin	7000-12000/Min
E T.BW.MTSG310-F	Φ10×2mm	细 Thin	7000-12000/Min
F T.BW.MTSG110-F	Φ10×1.8mm	细 Thin	7000-12000/Min



包装 Package: 100 Pcs/box

### 硅胶磨头 Polyster polishing bits

代码 Model	尺寸 Size	砂度 Sandness	转数 Rotating of number
A T.BW.MTSG403-EF	Φ3×7mm	极细 Extra thin	7000-10000/Min
B T.BW.MTSG404-EF	Φ4×12mm	极细 Extra thin	7000-10000/Min
C T.BW.MTSG405-EF	Φ5×10mm	极细 Extra thin	7000-10000/Min
D T.BW.MTSG704-EF	Φ4×11mm	极细 Extra thin	7000-10000/Min
E T.BW.MTSG310-EF	Φ10×2mm	极细 Extra thin	7000-10000/Min
F T.BW.MTSG110-EF	Φ10×1.8mm	极细 Extra thin	7000-10000/Min

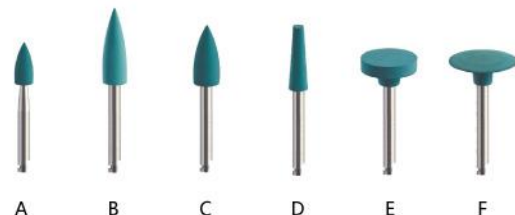

包装 Package: 100 Pcs/box

橡胶金刚石磨头  
Rubber diamond grinding bits

代码 Model	尺寸 Size	砂度 Sandness	转数 Rotating of number
A T.BW.MTRD505-M	Φ5×12mm	中粗 Medium thick	15000-20000/Min
B T.BW.MTRD205-M	Φ5×16mm	中粗 Medium thick	15000-20000/Min
C T.BW.MTRD406-M	Φ6×16mm	中粗 Medium thick	15000-20000/Min
D T.BW.MTRD404-M	Φ4×12mm	中粗 Medium thick	15000-20000/Min
E T.BW.MTRD704-M	Φ4×12mm	中粗 Medium thick	15000-20000/Min
F T.BW.MTRD312-M	Φ12×2mm	中粗 Medium thick	15000-20000/Min
G T.BW.MTRD112-M	Φ12×2mm	中粗 Medium thick	15000-20000/Min



包装 Package: 100 Pcs/box

橡胶金刚石磨头  
Rubber diamond grinding bits

代码 Model	尺寸 Size	砂度 Sandness	转数 Rotating of number
A T.BW.MTRD505-F	Φ5×12mm	细 Thin	15000-20000/Min
B T.BW.MTRD205-F	Φ5×16mm	细 Thin	15000-20000/Min
C T.BW.MTRD406-F	Φ6×16mm	细 Thin	15000-20000/Min
D T.BW.MTRD404-F-1	Φ4×12mm	细 Thin	15000-20000/Min
E T.BW.MTRD704-F-1	Φ4×12mm	细 Thin	15000-20000/Min
F T.BW.MTRD312-F	Φ12×2mm	细 Thin	15000-20000/Min
G T.BW.MTRD112-F	Φ12×2mm	细 Thin	15000-20000/Min



包装 Package: 100 Pcs/box

橡胶金刚石磨头  
Rubber diamond grinding bits

代码 Model	尺寸 Size	砂度 Sandness	转数 Rotating of number
A T.BW.MTRD505-EF	Φ5×12mm	极细 Extra thin	10000-15000/Min
B T.BW.MTRD205-EF	Φ5×16mm	极细 Extra thin	10000-15000/Min
C T.BW.MTRD406-EF	Φ6×16mm	极细 Extra thin	10000-15000/Min
D T.BW.MTRD404-EF-1	Φ4×12mm	极细 Extra thin	10000-15000/Min
E T.BW.MTRD704-EF-1	Φ4×12mm	极细 Extra thin	10000-15000/Min
F T.BW.MTRD312-EF	Φ12×2mm	极细 Extra thin	10000-15000/Min
G T.BW.MTRD112-EF	Φ12×2mm	极细 Extra thin	10000-15000/Min

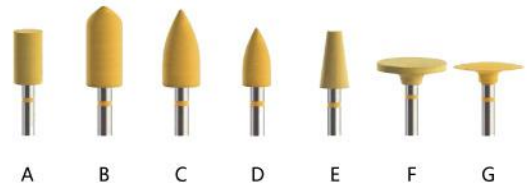

包装 Package: 100 Pcs/box

橡胶金刚石磨头  
Rubber diamond grinding bits

代码 Model	尺寸 Size	砂度 Sandness	转数 Rotating of number
A T.BW.MTRD403-C	Φ3×7mm	中粗 Medium thick	10000-15000/Min
B T.BW.MTRD404-C	Φ4×12mm	中粗 Medium thick	10000-15000/Min
C T.BW.MTRD405-C	Φ5×10mm	中粗 Medium thick	10000-15000/Min
D T.BW.MTRD704-C	Φ4×11mm	中粗 Medium thick	10000-15000/Min
E T.BW.MTRD906-C	Φ6×9.5mm	中粗 Medium thick	10000-15000/Min
F T.BW.MTRD909-C	Φ9×9mm	中粗 Medium thick	10000-15000/Min
G T.BW.MTRD310-C	Φ10×2mm	中粗 Medium thick	10000-15000/Min
H T.BW.MTRD110-C	Φ10×1.8mm	中粗 Medium thick	10000-15000/Min



包装 Package: 100 Pcs/box

### 橡胶金刚石磨头 Rubber diamond grinding bits

代码 Model	尺寸 Size	砂度 Sandness	转数 Rotating of number
A T.BW.MTRD403-F	Φ3×7mm	细 Thin	10000-15000/Min
B T.BW.MTRD404-F	Φ4×12mm	细 Thin	10000-15000/Min
C T.BW.MTRD405-C	Φ5×10mm	细 Thin	10000-15000/Min
D T.BW.MTRD704-F	Φ4×11mm	细 Thin	10000-15000/Min
E T.BW.MTRD906-F	Φ6×9.5mm	细 Thin	10000-15000/Min
F T.BW.MTRD909-F	Φ9×9mm	细 Thin	10000-15000/Min
G T.BW.MTRD310-F	Φ10×2mm	细 Thin	10000-15000/Min
H T.BW.MTRD110-F	Φ10×1.8mm	细 Thin	10000-15000/Min



包装 Package: 100 Pcs/box

### 橡胶金刚石磨头 Rubber diamond grinding bits

代码 Model	尺寸 Size	砂度 Sandness	转数 Rotating of number
A T.BW.MTRD403-EF	Φ3×7mm	极细 Extra thin	10000-15000/Min
B T.BW.MTRD404-EF	Φ4×12mm	极细 Extra thin	10000-15000/Min
C T.BW.MTRD405-EF	Φ5×10mm	极细 Extra thin	10000-15000/Min
D T.BW.MTRD704-EF	Φ4×11mm	极细 Extra thin	10000-15000/Min
E T.BW.MTRD906-EF	Φ6×9.5mm	极细 Extra thin	10000-15000/Min
F T.BW.MTRD909-EF	Φ9×9mm	极细 Extra thin	10000-15000/Min
G T.BW.MTRD310-EF	Φ10×2mm	极细 Extra thin	10000-15000/Min
H T.BW.MTRD110-EF	Φ10×1.8mm	极细 Extra thin	10000-15000/Min



包装 Package: 100 Pcs/box

### 橡胶磨头 Rubber grinding bits

代码 Model	尺寸 Size	砂度 Sandness	转数 Rotating of number
A T.BW.MTRP505-C	Φ5×12mm	粗 Thick	15000-20000/Min
B T.BW.MTRP205-C	Φ5×16mm	粗 Thick	15000-20000/Min
C T.BW.MTRP406-C	Φ6×16mm	粗 Thick	15000-20000/Min
D T.BW.MTRP404-C-1	Φ4×12mm	粗 Thick	15000-20000/Min
E T.BW.MTRP704-C-1	Φ4×12mm	粗 Thick	15000-20000/Min
F T.BW.MTRP310-C	Φ10×2mm	粗 Thick	15000-20000/Min
G T.BW.MTRP112-C	Φ12×2mm	粗 Thick	15000-20000/Min



包装 Package: 100 Pcs/box

### 橡胶磨头 Rubber grinding bits

代码 Model	尺寸 Size	砂度 Sandness	转数 Rotating of number
A T.BW.MTRP505-F	Φ5×12mm	细 Thin	10000-12000/Min
B T.BW.MTRP205-F	Φ5×16mm	细 Thin	10000-12000/Min
C T.BW.MTRP406-F	Φ6×16mm	细 Thin	10000-12000/Min
D T.BW.MTRP404-F-1	Φ4×12mm	细 Thin	10000-12000/Min
E T.BW.MTRP704-F-1	Φ4×12mm	细 Thin	10000-12000/Min
F T.BW.MTRP310-F	Φ10×2mm	细 Thin	10000-12000/Min
G T.BW.MTRP112-F	Φ12×2mm	细 Thin	10000-12000/Min



包装 Package: 100 Pcs/box

橡胶磨头  
Rubber grinding bits

代码 Model	尺寸 Size	砂度 Sandness	转数 Rotating of number
A T.BW.MTRP505-EF	Φ5×12mm	极细 Extra thin	10000-12000/Min
B T.BW.MTRP205-EF	Φ5×16mm	极细 Extra thin	10000-12000/Min
C T.BW.MTRP406-EF	Φ6×16mm	极细 Extra thin	10000-12000/Min
D T.BW.MTRP404-EF-1	Φ4×12mm	极细 Extra thin	10000-12000/Min
E T.BW.MTRP704-EF-1	Φ4×12mm	极细 Extra thin	10000-12000/Min
F T.BW.MTRP310-EF	Φ10×2mm	极细 Extra thin	10000-12000/Min
G T.BW.MTRP112-EF	Φ12×2mm	极细 Extra thin	10000-12000/Min



包装 Package: 100 Pcs/box

橡胶磨头  
Rubber grinding bits

代码 Model	尺寸 Size	砂度 Sandness	转数 Rotating of number
A T.BW.MTRP505-UF	Φ5×12mm	超细 Ultra-thin	10000-12000/Min
B T.BW.MTRP205-UF	Φ5×16mm	超细 Ultra-thin	10000-12000/Min
C T.BW.MTRP406-UF	Φ6×16mm	超细 Ultra-thin	10000-12000/Min
D T.BW.MTRP404-UF-1	Φ4×12mm	超细 Ultra-thin	10000-12000/Min
E T.BW.MTRP704-UF-1	Φ4×12mm	超细 Ultra-thin	10000-12000/Min
F T.BW.MTRP310-UF	Φ10×2mm	超细 Ultra-thin	10000-12000/Min
G T.BW.MTRP112-UF	Φ12×2mm	超细 Ultra-thin	10000-12000/Min



包装 Package: 100 Pcs/box

橡胶磨头  
Rubber grinding bits

代码 Model	尺寸 Size	砂度 Sandness	转数 Rotating of number
A T.BW.MTRP403-C	Φ3×7mm	粗 Thick	10000-15000/Min
B T.BW.MTRP404-C	Φ4×12mm	粗 Thick	10000-15000/Min
C T.BW.MTRP405-C	Φ5×10mm	粗 Thick	10000-15000/Min
D T.BW.MTRP704-C	Φ4×11mm	粗 Thick	10000-15000/Min
E T.BW.MTRP906-C	Φ6×9.5mm	粗 Thick	10000-15000/Min
F T.BW.MTRP909-C	Φ9×9mm	粗 Thick	10000-15000/Min
G T.BW.MTRP312-C	Φ12×2mm	粗 Thick	10000-15000/Min
H T.BW.MTRP110-C	Φ10×1.8mm	粗 Thick	10000-15000/Min



包装 Package: 100 Pcs/box

橡胶磨头  
Rubber grinding bits

代码 Model	尺寸 Size	砂度 Sandness	转数 Rotating of number
A T.BW.MTRP403-F	Φ3×7mm	细 Thin	10000-15000/Min
B T.BW.MTRP404-F	Φ4×12mm	细 Thin	10000-15000/Min
C T.BW.MTRP405-F	Φ5×10mm	细 Thin	10000-15000/Min
D T.BW.MTRP704-F	Φ4×11mm	细 Thin	10000-15000/Min
E T.BW.MTRP906-F	Φ6×9.5mm	细 Thin	10000-15000/Min
F T.BW.MTRP909-F	Φ9×9mm	细 Thin	10000-15000/Min
G T.BW.MTRP312-F	Φ12×2mm	细 Thin	10000-15000/Min
H T.BW.MTRP110-F	Φ10×1.8mm	细 Thin	10000-15000/Min



包装 Package: 100 Pcs/box

### 橡胶磨头 Rubber grinding bits

代码 Model	尺寸 Size	砂度 Sandness	转数 Rotating of number
A T.BW.MTRP403-EF	Φ3×7mm	极细 Extra thin	10000-12000/Min
B T.BW.MTRP404-EF	Φ4×12mm	极细 Extra thin	10000-12000/Min
C T.BW.MTRP405-EF	Φ5×10mm	极细 Extra thin	10000-12000/Min
D T.BW.MTRP704-EF	Φ4×11mm	极细 Extra thin	10000-12000/Min
E T.BW.MTRP906-EF	Φ6×9.5mm	极细 Extra thin	10000-12000/Min
F T.BW.MTRP909-EF	Φ9×9mm	极细 Extra thin	10000-12000/Min
G T.BW.MTRP312-EF	Φ12×2mm	极细 Extra thin	10000-12000/Min
H T.BW.MTRP110-EF	Φ10×1.8mm	极细 Extra thin	10000-12000/Min



包装 Package: 100 Pcs/box

### 橡胶磨头 Rubber grinding bits

代码 Model	尺寸 Size	砂度 Sandness	转数 Rotating of number
A T.BW.MTRP403-UF	Φ3×7mm	超细 Ultra-thin	10000-12000/Min
B T.BW.MTRP404-UF	Φ4×12mm	超细 Ultra-thin	10000-12000/Min
C T.BW.MTRP405-UF	Φ5×10mm	超细 Ultra-thin	10000-12000/Min
D T.BW.MTRP704-UF	Φ4×11mm	超细 Ultra-thin	10000-12000/Min
E T.BW.MTRP906-UF	Φ6×9.5mm	超细 Ultra-thin	10000-12000/Min
F T.BW.MTRP909-UF	Φ9×9mm	超细 Ultra-thin	10000-12000/Min
G T.BW.MTRP312-UF	Φ12×2mm	超细 Ultra-thin	10000-12000/Min
H T.BW.MTRP110-UF	Φ10×1.8mm	超细 Ultra-thin	10000-12000/Min



包装 Package: 100 Pcs/box

### 陶瓷磨头 Ceramic polishing bits

代码 Model	尺寸 Size	砂度 Sandness	转数 Rotating of number
A T.BW.MTCG2437	Φ3×7mm	粗 Thick	7000-10000/Min
B T.BW.MTCG2438	Φ3×8mm	粗 Thick	7000-10000/Min
C T.BW.MTCG2737	Φ3×7mm	粗 Thick	7000-10000/Min
D T.BW.MTCG2033	Φ3×3mm	粗 Thick	7000-10000/Min

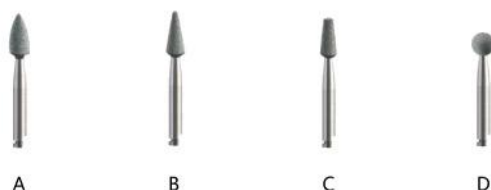

包装 Package: 100 Pcs/box

### 陶瓷磨头 Ceramic polishing bits

代码 Model	尺寸 Size	砂度 Sandness	转数 Rotating of number
A T.BW.MTCW2437	Φ3×7mm	细 Thin	7000-10000/Min
B T.BW.MTCW2438	Φ3×8mm	细 Thin	7000-10000/Min
C T.BW.MTCW2737	Φ3×7mm	细 Thin	7000-10000/Min
D T.BW.MTCW2033	Φ3×3mm	细 Thin	7000-10000/Min

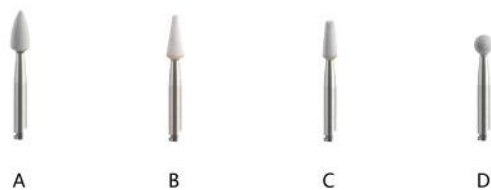

包装 Package: 100 Pcs/box

### 陶瓷磨头 Ceramic polishing bits

代码 Model	尺寸 Size	砂度 Sandness	转数 Rotating of number
A T.BW.MTCG3437	Φ3×7mm	粗 Thick	7000-10000/Min
B T.BW.MTCG3438	Φ3×8mm	粗 Thick	7000-10000/Min
C T.BW.MTCG3737	Φ3×7mm	粗 Thick	7000-10000/Min
D T.BW.MTCG3033	Φ3×3mm	粗 Thick	7000-10000/Min

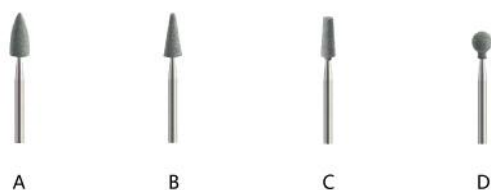

包装 Package: 100 Pcs/box

陶瓷磨头  
Ceramic polishing bits

代码 Model	尺寸 Size	砂度 Sandness	转数 Rotating of number
A T.BW.MTCW3437	Φ3×7mm	细 Thin	7000-10000/Min
B T.BW.MTCW3438	Φ3×8mm	细 Thin	7000-10000/Min
C T.BW.MTCW3737	Φ3×7mm	细 Thin	7000-10000/Min
D T.BW.MTCW3033	Φ3×3mm	细 Thin	7000-10000/Min

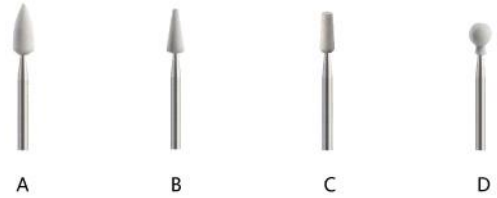

包装 Package: 100 Pcs/box



RA抛光套装  
RA Polishing set  
T.BW.MT3306-D



RA抛光套装  
RA Polishing set  
T.BW.MT3308-D



RA抛光套装  
RA Polishing set  
T.BW.MTRA0309-D



RA抛光套装  
RA Polishing set  
T.BW.MTRA0109-D



HR抛光套装  
HR Polishing set  
T.BW.MTHP0412-D



HR抛光套装  
HR Polishing set  
T.BW.MTHP0412-2-D



抛光套装  
HR Polishing set  
T.BW.MTHP0312-D



## 胶轮

## Plastic wheel

型号 Model	形状 Shape	尺寸 size (mm)
T.BWJM210-A	轮子 Wheel	14.7x3.7
T.BWJM211-A	轮子 Wheel	12.4x1.9
T.BWJM213-A	圆柱 Cylinder	18x5.4
T.BWJM213S-A	圆柱 Cylinder	16.8x5
T.BWJM228-A	圆柱 Cylinder	9x4
T.BWJ41-D	圆柱 Cylinder	17x5
T.BWJ42-D	轮子 Wheel	15x2.4
T.BWJ43-D	轮子 Wheel	14.7x2.2
T.BWJ47-D	轮子 Wheel	21.8x1.3
T.BWJ13S-D	圆柱 Cylinder	16.8x5



## 胶轮

## Plastic wheel

型号 Model	形状 Shape	尺寸 size (mm)
T.BWJM310-B	轮子 Wheel	13x3.7
T.BWJM311-B	轮子 Wheel	12.2x2.15
T.BWJM313-B	圆柱 Cylinder	18x5.4
T.BWJM313S-B	圆柱 Cylinder	12.2x9.6
T.BWJM328-B	圆柱 Cylinder	9x4
T.BWJM3162-B	轮子 Wheel	21.5x1.3



## 胶轮

## Plastic wheel

型号 Model	形状 Shape	尺寸 size (mm)
T.BWJ101-C	圆柱 Cylinder	16.5x5
T.BWJM310-C	轮子 Wheel	12.2x3
T.BWJM311-C	轮子 Wheel	12.2x2.3
T.BWJM313-C	圆柱 Cylinder	16.5x5.4
T.BWJM313S-C	圆柱 Cylinder	16.5x5



木芯毛刷

Wood Hub Bristle Brush

代码 Model	直径 Diameter	毛长 Wool Length	中心孔 Centre Hole	木芯直径 Core Diameter	行数 Row Number
T.BW.B1033	68mm	10mm	6.5mm	48mm	1
T.BW.B1022	68mm	10mm	6.5mm	48mm	2

包装 Package:

T.BW.B1033 200 Pcs/Box 8 Boxes/Carton  
T.BW.B1022 144 Pcs/Box 8 Boxes/Carton



木芯毛刷

Wood Hub Bristle Brush

代码 Model	直径 Diameter	毛长 Wool Length	中心孔 Centre Hole	木芯直径 Core Diameter	行数 Row Number
T.BW.B1031	68mm	10mm	6.5mm	48mm	1

包装 Package:

192 Pcs/Box 8 Boxes/Carton

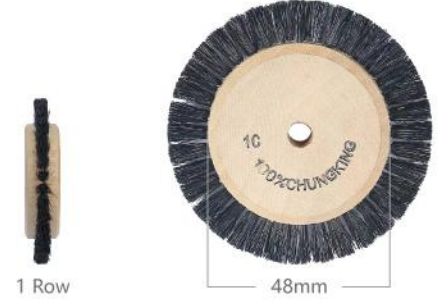

木芯毛刷

Wood Hub Bristle Brush

代码 Model	直径 Diameter	毛长 Wool Length	中心孔 Centre Hole	木芯直径 Core Diameter	行数 Row Number
T.BW.B1027	68mm	10mm	6.5mm	48mm	2

包装 Package:

168 Pcs/Box 8 Boxes/Carton

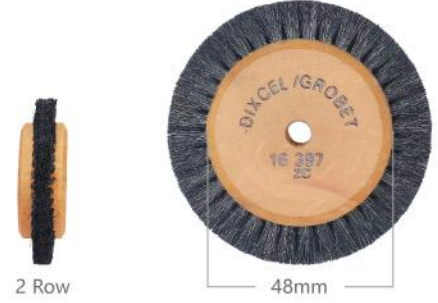

木芯毛刷

Wood Hub Bristle Brush

代码 Model	直径 Diameter	毛长 Wool Length	中心孔 Centre Hole	木芯直径 Core Diameter	行数 Row Number
T.BW.B1019	68mm	10mm	6.5mm	48mm	2
T.BW.B1019-C	68mm	10mm	6.5mm	48mm	6

包装 Package:

144 Pcs/Box 8 Boxes/Carton



木芯毛刷

Wood Hub Bristle Brush

代码 Model	直径 Diameter	毛长 Wool Length	中心孔 Centre Hole	木芯直径 Core Diameter	行数 Row Number
T.BW.B1036	68mm	10mm	6.5mm	48mm	2

包装 Package:

144 Pcs/Box 8 Boxes/Carton



4C木芯德国长毛刷  
4C Wood Hub Long Bristle Brush (Germany)

代码 Model	直径 Diameter	毛长 Wool Length	中心孔 Centre Hole	木心直径 Core Diameter	排数 Row Number
T.BW.B1035	78mm	19mm	6.5mm	40mm	4

包装 Package:  
125 Pcs/Box 8 Boxes/Carton



4 Row

40mm

黄色胶芯毛刷  
Yellow Brush with plastic core

代码 Model	直径 Diameter	毛长 Wool Length	中心孔 Centre Hole	塑料直径 Plastic Diameter	排数 Row Number
T.BW.A1030	54mm	13.5mm	6.5mm	27mm	2
T.BW.A1011	80mm	20mm	6.5mm	40mm	2

包装 Package:  
T.BW.A1030 12 Pcs/Pack 400 Pack/Carton  
T.BW.A1011 250 Pcs/Box 4 Boxes/Carton



T.BW.A1030

T.BW.A1011

27mm

40mm

胶芯毛刷  
Brush with plastic core

代码 Model	直径 Diameter	毛长 Wool Length	中心孔 Centre Hole	塑料直径 Plastic Diameter	排数 Row Number
T.BW.A1010	65mm	15mm	6.5mm	35mm	2

包装 Package:  
250 Pcs/Box 8 Boxes/Carton



2 Row

35mm

胶芯毛刷  
Brush with plastic core

代码 Model	直径 Diameter	毛长 Wool Length	中心孔 Centre Hole	塑料直径 Plastic Diameter	排数 Row Number
T.BW.A1016	68mm	10mm	6.5mm	48mm	2

包装 Package:  
300 Pcs/Box 8 Boxes/Carton



2 Row

48mm

胶芯毛刷  
Brush with plastic core

代码 Model	直径 Diameter	毛长 Wool Length	中心孔 Centre Hole	塑料直径 Plastic Diameter	排数 Row Number
T.BW.A1031	78mm	19mm	6.5mm	40mm	6
T.BW.A1031-C	78mm	19mm	6.5mm	40mm	6

包装 Package:  
100Pcs/Box 5 Boxes/Carton

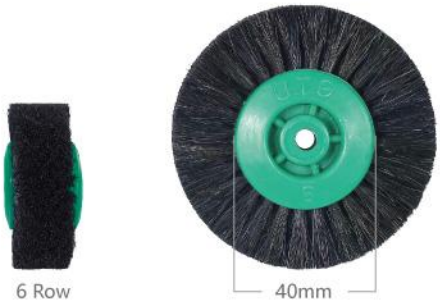

6 Row

40mm

胶芯毛刷

Brush with plastic core

代码 Model	直径 Diameter	毛长 Wool Length	中心孔 Centre Hole	塑料直径 Plastic Diameter	行数 Row Number
T.BW.A1002	78mm	19mm	6.5mm	40mm	4
T.BW.A1002-C	78mm	19mm	6.5mm	40mm	3-4

包装 Package:

125 Pcs/Box 8 Boxes/Carton



胶芯毛刷

Brush with plastic core

代码 Model	直径 Diameter	毛长 Wool Length	中心孔 Centre Hole	塑料直径 Plastic Diameter	行数 Row Number
T.BW.A1029-B	78mm	19mm	6.5mm	38mm	6

包装 Package:

100 Pcs/Box 5 Boxes/Carton



胶芯毛刷

Brush with plastic core

代码 Model	直径 Diameter	毛长 Wool Length	中心孔 Centre Hole	塑料直径 Plastic Diameter	行数 Row Number
T.BW.A1032	68mm	13mm	6.5mm	40mm	6
T.BW.A1032-C	68mm	13mm	6.5mm	40mm	6

包装 Package:

100 Pcs/Box 5 Boxes/Carton



胶芯毛刷

Brush with plastic core

代码 Model	直径 Diameter	毛长 Wool Length	中心孔 Centre Hole	木心直径 Core Diameter	行数 Row Number
T.BW.A1050	78mm	19mm	6.5mm	40mm	3

包装 Package:

100 Pcs/Box 5 Boxes/Carton



胶芯毛刷

Brush with plastic core

代码 Model	直径 Diameter	毛长 Wool Length	中心孔 Centre Hole	塑料直径 Plastic Diameter	行数 Row Number
T.BW.A1033	68mm	14mm	6.5mm	40mm	6
T.BW.A1033-C	68mm	14mm	6.5mm	40mm	6

包装 Package:

100 Pcs/Box 5 Boxes/Carton

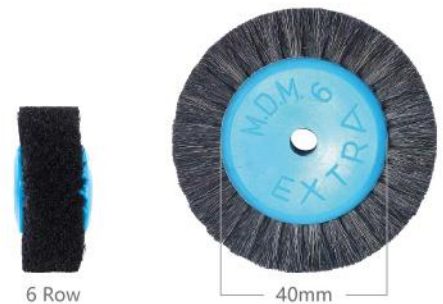

白羊毛木芯毛刷

White wool brush with wooden core

代码 Model	直径 Diameter	毛长 Wool Length	中心孔 Centre Hole	木心直径 Core Diameter	排数 Row Number
T.BW.B1037	78mm	19mm	6.5mm	40mm	4

包装 Package:

125 Pcs/Box 5 Boxes/Carton

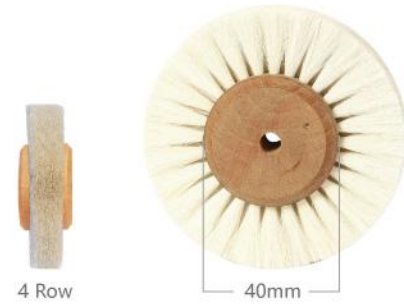

白羊毛胶芯毛刷

White wool brush with plastic core

代码 Model	直径 Diameter	毛长 Wool Length	中心孔 Centre Hole	木心直径 Core Diameter	排数 Row Number
T.BW.A1034	78mm	19mm	6.5mm	40mm	4

包装 Package:

125 Pcs/Box 5 Boxes/Carton

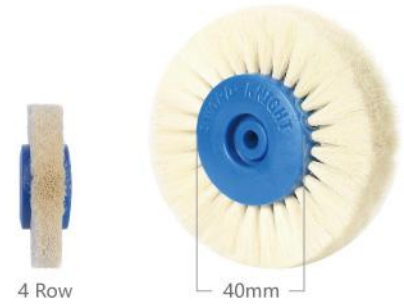

胶芯铜丝刷

Copper brush with plastic core

代码 Model	直径 Diameter	毛长 Wool Length	中心孔 Centre Hole	木心直径 Core Diameter	排数 Row Number
T.BW.A2010-B	78mm	19mm	6.5mm	40mm	4
T.BW.A2010-C	78mm	19mm	6.5mm	40mm	4

包装 Package:

125 Pcs/Box 5 Boxes/Carton

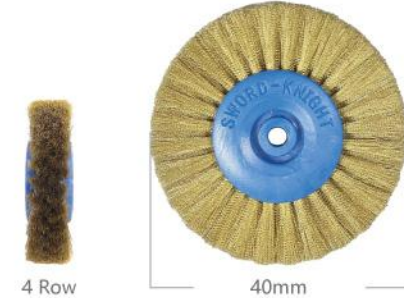

木芯线轮刷

Wire wheel brush with wooden core

代码 Model	直径 Diameter	毛长 Wool Length	中心孔 Centre Hole	木心直径 Core Diameter	排数 Row Number
T.BW.B1040	80mm	18mm	6.5mm	44mm	5
T.BW.B1041	70mm	13mm	6.5mm	44mm	5
T.BW.B1042	52mm	12mm	6.5mm	28mm	4

包装 Package:

T.BW.B1040 60 Pcs/Box 8 Boxes/Carton

T.BW.B1041 100 Pcs/Box 8 Boxes/Carton

T.BW.B1042 300 Pcs/Box 8 Boxes/Carton



有柄伞状毛刷灰白色  
Handled umbrella-shaped brush gray and white

代码 Model	直径 Diameter	长度 Length	铁杆直径 Rod Diameter	铁芯直径 Core Diameter
T.BW.MS045-17	17mm	42mm	2.35mm	10mm
T.BW.MS045-19	19mm	42mm	2.35mm	10mm
T.BW.MS045-22	22mm	42mm	2.35mm	10mm
T.BW.MS045-25	25mm	42mm	2.35mm	10mm



白灰羊毛  
White & Grey Wool

包装 Package: 144 Pcs/Box 10 Boxes/Carton

有柄伞状毛刷深灰色  
Handled umbrella brush dark gray

代码 Model	直径 Diameter	长度 Length	铁杆直径 Rod Diameter	铁芯直径 Core Diameter
T.BW.MS046-17	17mm	42mm	2.35mm	10mm
T.BW.MS046-19	19mm	42mm	2.35mm	10mm
T.BW.MS046-22	22mm	42mm	2.35mm	10mm
T.BW.MS046-25	25mm	42mm	2.35mm	10mm



黑花羊毛  
Black & White Wool

包装 Package: 144 Pcs/Box 10 Boxes/Carton

有柄伞状毛刷灰白色  
Handled umbrella-shaped brush gray and white

代码 Model	直径 Diameter	长度 Length	铁杆直径 Rod Diameter	铁芯直径 Core Diameter
T.BW.MS047-10.5	10.5mm	26mm	2.35mm	6mm
T.BW.MS047-12	12mm	26mm	2.35mm	6mm



包装 Package: 144 Pcs/Box 10 Boxes/Carton

有柄伞状毛刷白色  
Handled umbrella-shaped brush white

代码 Model	直径 Diameter	长度 Length	铁杆直径 Rod Diameter	铁芯直径 Core Diameter
T.BW.MS048-10.5	10.5mm	26mm	2.35mm	6mm
T.BW.MS048-12	12mm	26mm	2.35mm	6mm



包装 Package: 144 Pcs/Box 10 Boxes/Carton

有柄伞状毛刷灰白色  
Handled umbrella-shaped brush gray and white

代码 Model	直径 Diameter	长度 Length	铁杆直径 Rod Diameter	铁芯直径 Core Diameter
T.BW.MS034-17	17mm	42mm	2.35mm	10mm
T.BW.MS034-19	19mm	42mm	2.35mm	10mm
T.BW.MS034-22	22mm	42mm	2.35mm	10mm
T.BW.MS034-25	25mm	42mm	2.35mm	10mm



白灰羊毛  
White & Grey Wool

包装 Package: 144 Pcs/Box 10 Boxes/Carton

有柄伞状毛刷白黄色  
Handled umbrella-shaped brush with handle white and yellow

代码 Model	直径 Diameter	长度 Length	铁杆直径 Rod Diameter	铁芯直径 Core Diameter
T.BW.MS042-17	17mm	42mm	2.35mm	10mm
T.BW.MS042-19	19mm	42mm	2.35mm	10mm
T.BW.MS042-22	22mm	42mm	2.35mm	10mm
T.BW.MS042-25	25mm	42mm	2.35mm	10mm



白猪毛  
White Pig Hair

包装 Package: 144 Pcs/Box 10 Boxes/Carton

## 有柄伞状毛刷咖啡色

## Handled umbrella-shaped brush coffee

代码 Model	直径 Diameter	长度 Length	铁杆直径 Rod Diameter	铁芯直径 Core Diameter
T.BW.MS006-17	17mm	42mm	2.35mm	10mm
T.BW.MS006-19	19mm	42mm	2.35mm	10mm
T.BW.MS006-22	22mm	42mm	2.35mm	10mm
T.BW.MS006-25	25mm	42mm	2.35mm	10mm

白棕马毛  
White & Brown Horsehair

包装 Package: 144 Pcs/Box 10 Boxes/Carton

## 有柄伞状毛刷深灰色

## Handled umbrella-shaped brush dark gray

代码 Model	直径 Diameter	长度 Length	铁杆直径 Rod Diameter	铁芯直径 Core Diameter
T.BW.MS020-17	17mm	42mm	2.35mm	10mm
T.BW.MS020-19	19mm	42mm	2.35mm	10mm
T.BW.MS020-22	22mm	42mm	2.35mm	10mm
T.BW.MS020-25	25mm	42mm	2.35mm	10mm

黑灰羊毛  
Black & White Wool

包装 Package: 144 Pcs/Box 10 Boxes/Carton

## 有柄伞状毛刷黑色

## Handled umbrella-shaped brush black

代码 Model	直径 Diameter	长度 Length	铁杆直径 Rod Diameter	铁芯直径 Core Diameter
T.BW.MS005-17	17mm	42mm	2.35mm	10mm
T.BW.MS005-19	19mm	42mm	2.35mm	10mm
T.BW.MS005-22	22mm	42mm	2.35mm	10mm
T.BW.MS005-25	25mm	42mm	2.35mm	10mm

黑猪毛  
Black Pig Hair

包装 Package: 144 Pcs/Box 10 Boxes/Carton

## 有柄伞状毛刷白色

## Handled umbrella-shaped brush white

代码 Model	直径 Diameter	长度 Length	铁杆直径 Rod Diameter	铁芯直径 Core Diameter
T.BW.MS009-17	17mm	42mm	2.35mm	10mm
T.BW.MS009-19	19mm	42mm	2.35mm	10mm
T.BW.MS009-22	22mm	42mm	2.35mm	10mm
T.BW.MS009-25	25mm	42mm	2.35mm	10mm

白羊毛  
White Wool

包装 Package: 144 Pcs/Box 10 Boxes/Carton

## 无柄黑花羊毛毛刷

## Handleless black floral wool brush

代码 Model	直径 Diameter	中心孔 Centre Hole	铁芯直径 Core Diameter
T.BW.MS043-17	17mm	3.2mm	10mm
T.BW.MS043-19	19mm	3.2mm	10mm
T.BW.MS043-22	22mm </tr		



包装 Package: 20000 Pcs/Carton

## 无柄深黑马毛毛刷

## Handleless dark black horsehair brush

代码 Model	直径 Diameter	中心孔 Centre Hole	铁芯直径 Core Diameter
T.BW.MS035-17	17mm	3.2mm	10mm
T.BW.MS035-19	19mm	3.2mm	10mm
T.BW.MS035-22	22mm	3.2mm	10mm
T.BW.MS035-25	25mm	3.2mm	10mm



包装 Package: 20000 Pcs/Carton

无柄灰色毛刷  
Handleless gray brush

代码 Model	直径 Diameter	中心孔 Centre Hole	铁芯直径 Core Diameter
T.BW.MS025-17	17mm	3.2mm	10mm
T.BW.MS025-19	19mm	3.2mm	10mm
T.BW.MS025-22	22mm	3.2mm	10mm
T.BW.MS025-25	25mm	3.2mm	10mm

白灰羊毛  
White & Grey Wool



包装 Package: 20000 Pcs/Carton

无柄白色毛刷  
Handleless white brush

代码 Model	直径 Diameter	中心孔 Centre Hole	铁芯直径 Core Diameter
T.BW.MS018-17	17mm	3.2mm	10mm
T.BW.MS018-19	19mm	3.2mm	10mm
T.BW.MS018-22	22mm	3.2mm	10mm
T.BW.MS018-25	25mm	3.2mm	10mm

白羊毛  
White Wool



包装 Package: 20000 Pcs/Carton

无柄黑色毛刷  
Handleless black brush

代码 Model	直径 Diameter	中心孔 Centre Hole	铁芯直径 Core Diameter
T.BW.MS019-17	17mm	3.2mm	10mm
T.BW.MS019-19	19mm	3.2mm	10mm
T.BW.MS019-22	22mm	3.2mm	10mm
T.BW.MS019-25	25mm	3.2mm	10mm

黑猪毛  
Black Pig Hair



包装 Package: 20000 Pcs/Carton

有柄伞状铜丝刷  
Brass wire brush with handle

代码 Model	直径 Diameter	长度 Length	铁杆直径 Rod Diameter
T.BW.MS008-22	22mm	40mm	2.35mm
T.BW.MS008-25	25mm	40mm	2.35mm



包装 Package: 100 Pcs/Pack 100 Pack/Carton

有柄伞状钢丝刷  
Steel wire brush

代码 Model	直径 Diameter	长度 Length	铁杆直径 Rod Diameter
T.BW.MS003-22	22mm	40mm	2.35mm
T.BW.MS003-25	25mm	40mm	2.35mm



包装 Package: 100 Pcs/Pack 100 Pack/Carton



直扫系列  
Straight bristle

代码 Model	毛刷直径 Brush Diameter	毛刷长度 Brush length	总长度 Total Length	铁杆直径 Rod Diameter
T.BW.MS011	5mm	10mm	50mm	2.35mm
T.BW.MS041	5mm	10mm	50mm	2.35mm
T.BW.MS015	5mm	10mm	50mm	2.35mm
T.BW.MS016	5mm	10mm	50mm	2.35mm
T.BW.MS017	5mm	10mm	50mm	2.35mm
T.BW.MS027	5mm	10mm	50mm	2.35mm

包装 Package: 100 Pcs/Pack 100 Pack/Carton



碗刷系列  
Straight bristle

代码 Model	毛刷直径 Brush Diameter	毛刷长度 Brush length	总长度 Total Length	铁杆直径 Rod Diameter
T.BW.MS013	15mm	8.5mm	50mm	2.35mm
T.BW.MS033	15mm	8.5mm	50mm	2.35mm
T.BW.MS010	15mm	8.5mm	50mm	2.35mm
T.BW.MS029	15mm	8.5mm	50mm	2.35mm
T.BW.MS030	15mm	8.5mm	50mm	2.35mm
T.MS.MS042	15mm	8.5mm	50mm	2.35mm

包装 Package: 100 Pcs/Pack 100 Pack/Carton



代码 Model	直径 Diameter	长度 Length	铁杆直径 Rod Diameter
T.BW.L0001	22mm	42mm	2.35mm
T.BW.L0003	22mm	42mm	2.35mm
T.BW.L0006	22mm	42mm	2.35mm
T.BW.L0007	25mm	42mm	2.35mm
T.BW.L0008	22mm	42mm	2.35mm
T.BW.L0009	22mm	42mm	2.35mm
T.BW.L0010	22mm	42mm	2.35mm

包装 Package: 100 Pcs/Pack 100 Pack/Carton



有柄双层百洁布  
Nylon Buffing Polishing Wheel

代码 Model	直径 Diameter	长度 Length	铁杆直径 Rod Diameter
T.BW.D0022-22	22mm	40mm	2.35mm
T.BW.D0022-25	25mm	40mm	2.35mm
T.BW.L0026-22	22mm	40mm	2.35mm
T.BW.L0026-25	25mm	40mm	2.35mm



T.BW.L0026      T.BW.D0022  
包装 Package: 100 Pcs/Pack 100 Pack/Carton

铁芯毛刷  
Iron core brush

包装 Package:  
50 Pcs/Pack 200 Pcs/Box

代码 Model	直径 Diameter	毛长 Wool Length	中心孔 Centre Hole	铁芯直径 Core Diameter
T.BW.C1011	48mm	12mm	5mm	24mm
T.BW.C1013	48mm	12mm	5mm	24mm
T.BW.C1014	48mm	12mm	5mm	24mm
T.BW.C1015	48mm	12mm	5mm	24mm
T.BW.C1016	48mm	12mm	5mm	24mm



T.BW.C1011  
黑猪毛  
Black Pig Hair



T.BW.C1013  
黑灰羊毛  
Black & White Wool



T.BW.C1014  
黑马毛  
Black & Brown Horsehair



T.BW.C1015  
白羊毛  
White Wool



T.BW.C1016  
白棕马毛  
White&Brown Horsehair

铁芯铜丝刷  
Iron core copper wire brushre

代码 Model	直径 Diameter	厚度 Thickness	中心孔 Centre Hole	铁芯直径 Iron core Diameter
T.BW.C1017	50mm	4.5mm	5mm	25mm

包装 Package:  
50 Pcs/Pack 200 Pcs/Box



铁芯钢丝刷轮  
Iron core wire brush wheel

代码 Model	直径 Diameter	厚度 Thickness	中心孔 Centre Hole	铁芯直径 Iron core Diameter
T.BW.C1018	50mm	4.5mm	5mm	25mm

包装 Package:  
50 Pcs/Pack 200 Pcs/Box



## 深黄/浅黄布轮

## Dark yellow buff / Light yellow buff

代码 Model	尺寸 Size	层 Ply	包装 Package
T.BW.Y2550	2.5"	50	800 Pcs/Box
T.BW.Y3015	3"	15	800 Pcs/Box
T.BW.Y3025	3"	25	800 Pcs/Box
T.BW.Y3040	3"	40	800 Pcs/Box
T.BW.Y3050	3"	50	800 Pcs/Box
T.BW.Y4015	4"	15	800 Pcs/Box
T.BW.Y4025	4"	25	800 Pcs/Box
T.BW.Y4040	4"	40	600 Pcs/Box
T.BW.Y4050	4"	50	500 Pcs/Box
T.BW.Y5015	5"	15	720 Pcs/Box
T.BW.Y5025	5"	25	480 Pcs/Box
T.BW.Y5040	5"	40	360 Pcs/Box
T.BW.Y5050	5"	50	360 Pcs/Box
T.BW.Y6015	6"	15	360 Pcs/Box
T.BW.Y6025	6"	25	360 Pcs/Box
T.BW.Y6040	6"	40	300 Pcs/Box
T.BW.Y6050	6"	50	240 Pcs/Box
T.BW.Y6060	6"	60	180 Pcs/Box
T.BW.Y6080	6"	80	160 Pcs/Box
T.BW.Y7015	7"	15	360 Pcs/Box
T.BW.Y7025	7"	25	240 Pcs/Box
T.BW.Y7030	7"	30	240 Pcs/Box
T.BW.Y7040	7"	40	180 Pcs/Box
T.BW.Y7050	7"	50	180 Pcs/Box
T.BW.Y7060	7"	60	150 Pcs/Box
T.BW.Y8015	8"	15	360 Pcs/Box
T.BW.Y8025	8"	25	240 Pcs/Box
T.BW.Y8030	8"	30	240 Pcs/Box
T.BW.Y8035	8"	35	180 Pcs/Box
T.BW.Y8040	8"	40	180 Pcs/Box
T.BW.Y8050	8"	50	160 Pcs/Box
T.BW.Y8060	8"	60	120 Pcs/Box
T.BW.Y8070	8"	70	120 Pcs/Box
T.BW.Y1030	10"	30	100 Pcs/Box
T.BW.Y1050	10"	50	80 Pcs/Box
T.BW.Y1250	12"	50	60 Pcs/Box



## 加厚黄布轮

## Thickened yellow buff

代码 Model	尺寸 Size	层 Ply	包装 Package
T.BW.Y4000	4"	50	400 Pcs/Box
T.BW.Y5000	5"	50	240 Pcs/Box
T.BW.Y6000	6"	50	180 Pcs/Box
T.BW.Y7000	7"	50	120 Pcs/Box
T.BW.Y7000-60	7"	60	120 Pcs/Box
T.BW.Y8000	8"	50	120 Pcs/Box



蓝色布轮  
Blue buff

代码 Model	尺寸 Size	层 Ply	包装 Package
T.BW.B2550	2.5"	50	800 Pcs/Box
T.BW.B0315	3"	15	800 Pcs/Box
T.BW.B0325	3"	25	800 Pcs/Box
T.BW.B0340	3"	40	800 Pcs/Box
T.BW.B0350	3"	50	800 Pcs/Box
T.BW.B0415	4"	15	800 Pcs/Box
T.BW.B0425	4"	25	800 Pcs/Box
T.BW.B0440	4"	40	600 Pcs/Box
T.BW.B0450	4"	50	500 Pcs/Box
T.BW.B0515	5"	15	720 Pcs/Box
T.BW.B0525	5"	25	480 Pcs/Box
T.BW.B0540	5"	40	360 Pcs/Box
T.BW.B0550	5"	50	360 Pcs/Box
T.BW.B0615	6"	15	360 Pcs/Box
T.BW.B0625	6"	25	360 Pcs/Box
T.BW.B0640	6"	40	300 Pcs/Box
T.BW.B0650	6"	50	240 Pcs/Box
T.BW.B0660	6"	60	180 Pcs/Box
T.BW.B0680	6"	80	160 Pcs/Box
T.BW.B0715	7"	15	360 Pcs/Box
T.BW.B0725	7"	25	240 Pcs/Box
T.BW.B0730	7"	30	240 Pcs/Box
T.BW.B0740	7"	40	180 Pcs/Box
T.BW.B0750	7"	50	180 Pcs/Box
T.BW.B0760	7"	60	150 Pcs/Box
T.BW.B0815	8"	15	360 Pcs/Box
T.BW.B0825	8"	25	240 Pcs/Box
T.BW.B0830	8"	30	240 Pcs/Box
T.BW.B0835	8"	35	180 Pcs/Box
T.BW.B0840	8"	40	180 Pcs/Box
T.BW.B0850	8"	50	160 Pcs/Box
T.BW.B0860	8"	60	120 Pcs/Box
T.BW.B0870	8"	70	120 Pcs/Box
T.BW.B1030	10"	30	100 Pcs/Box
T.BW.B1050	10"	50	80 Pcs/Box
T.BW.B1250	12"	50	60 Pcs/Box

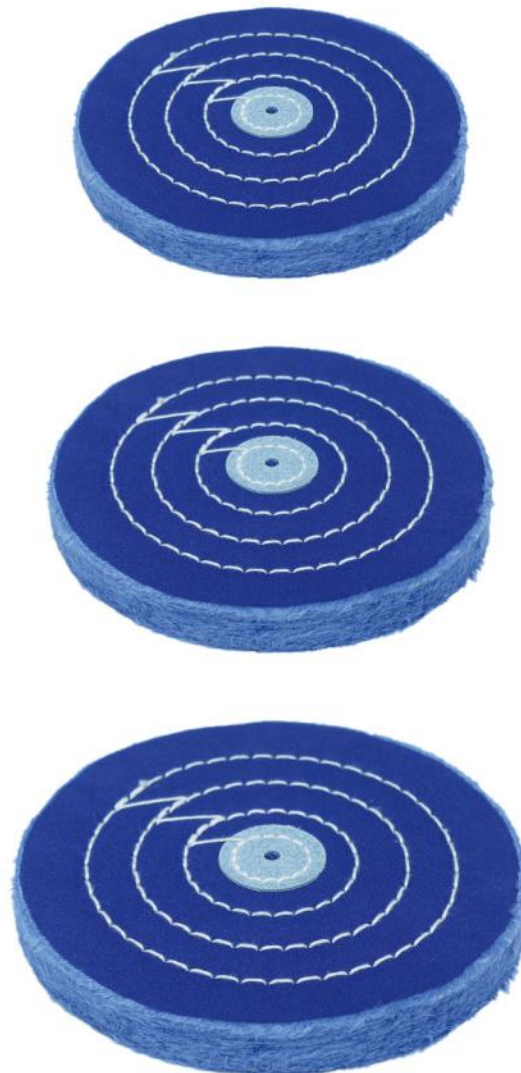

紫色布轮  
Purple buff

代码 Model	尺寸 Size	层 Ply	包装 Package
T.BW.P2550	2.5"	50	800 Pcs/Box
T.BW.P0315	3"	15	800 Pcs/Box
T.BW.P0325	3"	25	800 Pcs/Box
T.BW.P0340	3"	40	800 Pcs/Box
T.BW.P0350	3"	50	800 Pcs/Box
T.BW.P0415	4"	15	800 Pcs/Box
T.BW.P0425	4"	25	800 Pcs/Box
T.BW.P0440	4"	40	600 Pcs/Box

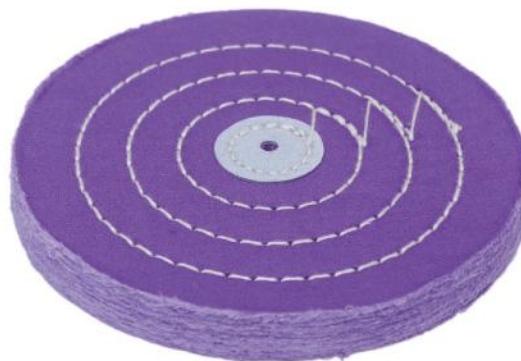

紫色布轮  
Purple buff

代码 Model	尺寸 Size	层 Ply	包装 Package
T.BW.P0450	4"	50	500 Pcs/Box
T.BW.P0515	5"	15	720 Pcs/Box
T.BW.P0525	5"	25	480 Pcs/Box
T.BW.P0540	5"	40	360 Pcs/Box
T.BW.P0550	5"	50	360 Pcs/Box
T.BW.P0615	6"	15	360 Pcs/Box
T.BW.P0625	6"	25	360 Pcs/Box
T.BW.P0640	6"	40	300 Pcs/Box
T.BW.P0650	6"	50	240 Pcs/Box
T.BW.P0660	6"	60	180 Pcs/Box
T.BW.P0680	6"	80	160 Pcs/Box
T.BW.P0715	7"	15	360 Pcs/Box
T.BW.P0725	7"	25	240 Pcs/Box
T.BW.P0730	7"	30	240 Pcs/Box
T.BW.P0740	7"	40	180 Pcs/Box
T.BW.P0750	7"	50	180 Pcs/Box
T.BW.P0760	7"	60	150 Pcs/Box
T.BW.P0815	8"	15	360 Pcs/Box
T.BW.P0825	8"	25	240 Pcs/Box
T.BW.P0830	8"	30	240 Pcs/Box
T.BW.P0835	8"	35	180 Pcs/Box
T.BW.P0840	8"	40	180 Pcs/Box
T.BW.P0850	8"	50	160 Pcs/Box
T.BW.P0860	8"	60	120 Pcs/Box
T.BW.P0870	8"	70	120 Pcs/Box
T.BW.P1030	10"	30	100 Pcs/Box
T.BW.P1050	10"	50	80 Pcs/Box
T.BW.P1250	12"	50	60 Pcs/Box

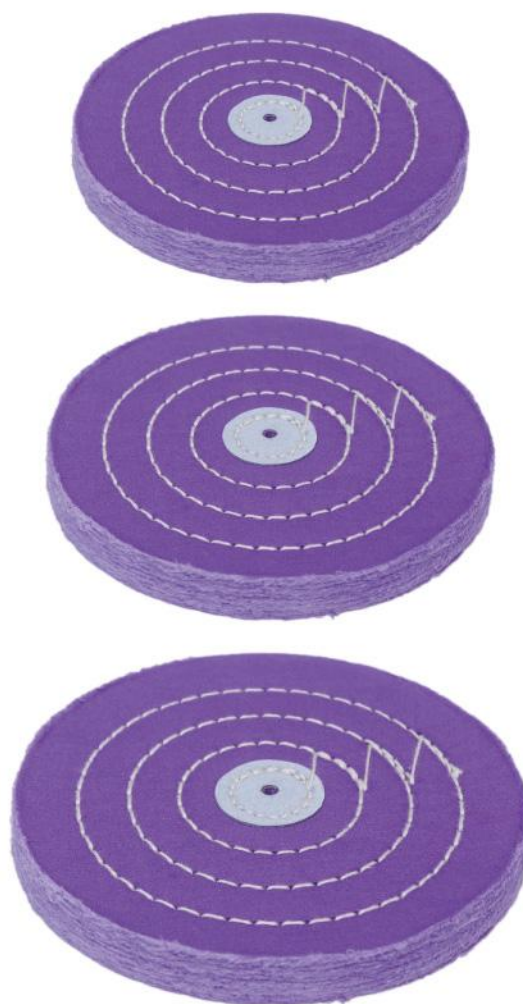
白布轮  
White buff

代码 Model	尺寸 Size	层 Ply
T.BW.W2550	2.5"	50
T.BW.W0350	3"	50
T.BW.W0415	4"	15
T.BW.W0425	4"	25
T.BW.W0440	4"	40
T.BW.W0450	4"	50
T.BW.W0515	5"	15
T.BW.W0525	5"	25
T.BW.W0540	5"	40
T.BW.W0550	5"	50
T.BW.W0615	6"	15
T.BW.W0625	6"	25
T.BW.W0630	6"	30
T.BW.W0640	6"	40
T.BW.W0650	6"	50
T.BW.W0660	6"	60



白布轮  
White buff

代码 Model	尺寸 Size	层 Ply
T.BW.W0680	6"	80
T.BW.W0715	7"	15
T.BW.W0725	7"	25
T.BW.W0730	7"	30
T.BW.W0740	7"	40
T.BW.W0750	7"	50
T.BW.W0815	8"	15
T.BW.W0825	8"	25
T.BW.W0830	8"	30
T.BW.W0835	8"	35
T.BW.W0840	8"	40
T.BW.W0850	8"	50
T.BW.W0860	8"	60
T.BW.W0890	8"	90
T.BW.W08120	8"	120
T.BW.W1050	10"	50
T.BW.W1250	12"	50



麻轮  
Flax wheel

代码 Model	尺寸 Size	层 Ply
T.BW.M5006	5"	6
T.BW.M6007	6"	7
T.BW.M9005	9"	5
T.BW.M1203	12"	3
T.BW.M1206	12"	6
T.BW.M1205	12"	5
T.BW.M6000	6"	5
T.BW.M7000	7"	5
T.BW.M8000	8"	5
T.BW.M1000	10"	5
T.BW.M1007	10"	7
T.BW.M1007-2	10"	7
T.BW.M1105	11"	5
T.BW.M1207-1	12"	7
T.BW.M1207-2	12"	7



6寸尼龙轮  
6" Nylon wheel

代码 Model	厚度 Thickness	硬度 Hardness	目数 Mesh count
T.BW.N08102	2"	16P	180#
T.BW.N08103	2"	16P	240#
T.BW.N08104	2"	16P	320#
T.BW.N08105	2"	16P	400#
T.BW.N08106	2"	16P	600#



8寸尼龙轮  
8" Nylon wheel

代码 Model	厚度 Thickness	硬度 Hardness	目数 Mesh count
T.BW.N0861	1"	5P	60#
T.BW.N0862	1"	5P	80#
T.BW.N0863	1"	5P	120#
T.BW.N0813	1"	5P	180#
T.BW.N0814	1"	5P	240#
T.BW.N0812	1"	5P	320#
T.BW.N0815	1"	5P	400#
T.BW.N0844	1"	5P	600#
T.BW.N0853	1"	7P	60#
T.BW.N0864	1"	7P	80#
T.BW.N0840	1"	7P	120#
T.BW.N0813	1"	7P	180#
T.BW.N0814	1"	7P	240#
T.BW.N0839	1"	7P	320#
T.BW.N0815	1"	7P	400#
T.BW.N0865	1"	7P	600#
T.BW.N0866	1"	9P	60#
T.BW.N0845	1"	9P	80#
T.BW.N0867	1"	9P	120#
T.BW.N0823	1"	9P	180#
T.BW.N0824	1"	9P	240#
T.BW.N0803	1"	9P	320#
T.BW.N0802	1"	9P	400#
T.BW.N0834	1"	9P	600#
T.BW.N0837	1"	12P	60#
T.BW.N0868	1"	12P	80#
T.BW.N0869	1"	12P	120#
T.BW.N0816	1"	12P	180#
T.BW.N0805	1"	12P	240#
T.BW.N0804	1"	12P	320#
T.BW.N0820	1"	12P	400#
T.BW.N0852	1"	12P	600#
T.BW.N0870	1"	16P	60#
T.BW.N0871	1"	16P	80#
T.BW.N0872	1"	16P	120#
T.BW.N0833	1"	16P	180#
T.BW.N0821	1"	16P	240#
T.BW.N0832	1"	16P	320#
T.BW.N0873	1"	16P	400#
T.BW.N0874	1"	16P	600#



8寸尼龙轮  
8" Nylon wheel

代码 Model	厚度 Thickness	硬度 Hardness	目数 Mesh count
T.BW.N0875	2"	5P	60#
T.BW.N0876	2"	5P	80#
T.BW.N0877	2"	5P	120#
T.BW.N0878	2"	5P	180#
T.BW.N0879	2"	5P	240#
T.BW.N0851	2"	5P	320#
T.BW.N0880	2"	5P	400#
T.BW.N0881	2"	5P	600#
T.BW.N0882	2"	7P	60#
T.BW.N0883	2"	7P	80#
T.BW.N0884	2"	7P	120#
T.BW.N0849	2"	7P	180#
T.BW.N0885	2"	7P	240#
T.BW.N0886	2"	7P	320#
T.BW.N0887	2"	7P	400#
T.BW.N0888	2"	7P	600#
T.BW.N0889	2"	9P	60#
T.BW.N0890	2"	9P	80#
T.BW.N0891	2"	9P	120#
T.BW.N0841	2"	9P	180#
T.BW.N0892	2"	9P	240#
T.BW.N0893	2"	9P	320#
T.BW.N0807	2"	9P	400#
T.BW.N0894	2"	9P	600#
T.BW.N0895	2"	12P	60#
T.BW.N0896	2"	12P	80#
T.BW.N0897	2"	12P	120#
T.BW.N0898	2"	12P	180#
T.BW.N0836	2"	12P	240#
T.BW.N0850	2"	12P	320#
T.BW.N0898	2"	12P	400#
T.BW.N0860	2"	12P	600#
T.BW.N0899	2"	16P	60#
T.BW.N08100	2"	16P	80#
T.BW.N08101	2"	16P	120#
T.BW.N08102	2"	16P	400#
T.BW.N08103	2"	16P	600#
T.BW.N08104	2"	16P	60#
T.BW.N08105	2"	16P	80#
T.BW.N08106	2"	16P	120#

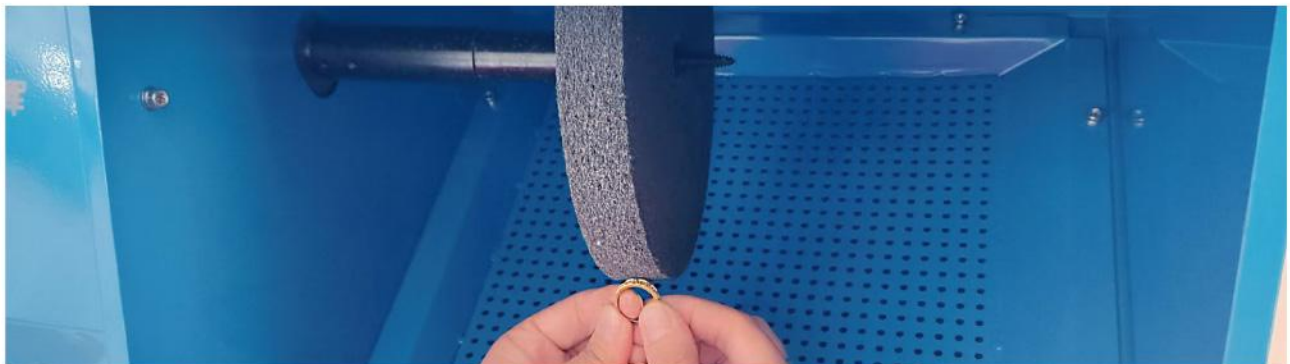

羊毛轮  
Wool wheel

代码 Model	尺寸 Size	厚度 Thickness	材质 Material
T.BW.L0024-A	4"	25mm	粗毛 Coarse wool
T.BW.L0024	4"	25mm	细毛 Fine wool
T.BW.L0027-B	5"	25mm	粗毛 Coarse wool
T.BW.L0027	5"	25mm	细毛 Fine wool
T.BW.L0027-30	5"	30mm	细毛 Fine wool
T.BW.L0021-B	6"	25mm	细毛 Fine wool
T.BW.L0021	6"	25mm	细毛 Fine wool
T.BW.L0021-30	6"	30mm	细毛 Fine wool
T.BW.L0028-B	8"	25mm	粗毛 Coarse wool
T.BW.L0028	8"	25mm	细毛 Fine wool
T.BW.L0028-30	8"	30mm	细毛 Fine wool
T.BW.L0029-B	10"	25mm	粗毛 Coarse wool
T.BW.L0029	10"	25mm	细毛 Fine wool
T.BW.L0029-30	10"	30mm	细毛 Fine wool
T.BW.L0030-B	12"	25mm	粗毛 Coarse wool
T.BW.L0030	12"	25mm	细毛 Fine wool
T.BW.L0030-30	12"	30mm	细毛 Fine wool

飞碟轮  
Split wheel

代码 Model	尺寸 Size	厚度 Thickness	硬度 Hardness
T.BW.F4001	4"	14mm	中 Medium
T.BW.F4002	4"	14mm	硬 Hard
T.BW.F4003	4"	14mm	特硬 Rock hard
T.BW.F4004	4"	14mm	超特硬 Flint hard
T.BW.F4005	4"	14mm	软 Soft
T.BW.F6001	6"	13mm	超特硬 Flint hard
T.BW.F6002	6"	13mm	硬 Hard
T.BW.F6003	6"	13mm	中 Medium
T.BW.F6006	6"	13mm	特硬 Rock hard
T.BW.F6007	6"	13mm	软 Soft
T.BW.F7001	7"	16mm	硬 Hard
T.BW.F7002	7"	16mm	中 Medium
T.BW.F7003	7"	16mm	特硬 Rock hard
T.BW.F7004	7"	16mm	软 Soft
T.BW.F7005	7"	16mm	超特硬 Flint hard

进口飞碟轮  
Imported split wheel

代码 Model	尺寸 Size	厚度 Thickness	硬度 Hardness
T.BW.F4006	4"	14mm	超特硬 Flint hard
T.BW.F4007	4"	14mm	中 Medium
T.BW.F4009	4"	14mm	硬 Hard
T.BW.F4008	4"	14mm	特硬 Rock hard
T.BW.F6005	6"	13mm	超特硬 Flint hard
T.BW.F6008	6"	13mm	硬 Hard
T.BW.F6009	6"	13mm	中 Medium
T.BW.F6010	6"	13mm	软 Soft
T.BW.F6011	6"	13mm	特硬 Rock hard



柏轮  
Cloth wheel

代码 Model	尺寸 Size	厚度 Thickness	硬度 Hardness
T.BW.B040S	4"	14mm	软 Soft
T.BW.B040M	4"	14mm	中 Medium
T.BW.B040H	4"	14mm	硬 Hard
T.BW.B040R	4"	14mm	特硬 Rock hard
T.BW.B040F	4"	14mm	超特硬 Flint hard
T.BW.B060H	6"	13mm	硬 Hard
T.BW.B060S	6"	14mm	软 Soft
T.BW.B060M	6"	14mm	中 Medium
T.BW.B060R	6"	14mm	特硬 Rock hard
T.BW.B060F	6"	14mm	超特硬 Flint hard
T.BW.B070S	7"	13mm	软 Soft
T.BW.B070M	7"	13mm	中 Medium
T.BW.B070H	7"	13mm	硬 Hard
T.BW.B070R	7"	13mm	特硬 Rock hard
T.BW.B070F	7"	13mm	超特硬 Flint hard



海绵抛光轮  
Sponge polishing wheel

代码 Model	直径 Diameter	厚度 Thickness	目数 Mesh count
T.BW.H0811	200mm	20mm	60#
T.BW.H0803	200mm	20mm	80#
T.BW.H0812	200mm	20mm	120#
T.BW.H0801	200mm	20mm	180#
T.BW.H0802	200mm	20mm	240#
T.BW.H0805	200mm	20mm	320#
T.BW.H0806	200mm	20mm	400#
T.BW.H0813	200mm	20mm	600#
T.BW.H0804	200mm	20mm	800#
T.BW.H0814	200mm	10mm	800#
T.BW.H0815	200mm	10mm	60#
T.BW.H0816	200mm	10mm	80#
T.BW.H0817	200mm	10mm	120#
T.BW.H0810	200mm	10mm	180#
T.BW.H0818	200mm	10mm	240#
T.BW.H0819	200mm	10mm	320#
T.BW.H0820	200mm	10mm	400#
T.BW.H0821	200mm	10mm	600#
T.BW.H0822	200mm	10mm	800#
T.BW.H0823	200mm	13mm	320#
T.BW.H0824	200mm	16mm	220#
T.BW.H0825	200mm	16mm	320#
T.BW.H0826	200mm	20mm	240#
T.BW.H0827	200mm	25mm	180#
T.BW.H0828	200mm	25mm	240#
T.BW.H0829	200mm	25mm	320#
T.BW.H0830	200mm	25mm	320#
T.BW.H0831	200mm	25mm	400#
T.BW.H0832	200mm	50mm	180#
T.BW.H0833	200mm	50mm	320#
T.BW.H0834	200mm	50mm	400#
T.BW.H0835	200mm	20mm	280#
T.BW.H0836	200mm	16mm	240#



## 8寸飞翼轮

## Non woven polishing wheel

代码 Model	厚度 Thickness	夹砂 Sand inclusion	目数 Mesh count
T.BW.FY0801-B	25mm	否 / No	240#
T.BW.FY0802-B	25mm	否 / No	320#
T.BW.FY0806-B	25mm	否 / No	60#
T.BW.FY0807-B	25mm	否 / No	80#
T.BW.FY0808-B	25mm	否 / No	120#
T.BW.FY0803-B	25mm	否 / No	180#
T.BW.FY0804-B	25mm	否 / No	400#
T.BW.FY0805-B	25mm	否 / No	600#
T.BW.FY0801	25mm	是 / Yes	240#
T.BW.FY0802	25mm	是 / Yes	320#
T.BW.FY0806	25mm	是 / Yes	60#
T.BW.FY0807	25mm	是 / Yes	80#
T.BW.FY0808	25mm	是 / Yes	120#
T.BW.FY0803	25mm	是 / Yes	180#
T.BW.FY0804	25mm	是 / Yes	400#
T.BW.FY0805	25mm	是 / Yes	600#



## 打磨轮

## Radial shape disc

代码 Model	直径 Diameter	目数 Mesh count
T.BW.S0039-14	14mm	80#
T.BW.S0039-19	19mm	80#
T.BW.S0039-24	24mm	80#
T.BW.S0040-14	14mm	120#
T.BW.S0040-19	19mm	120#
T.BW.S0040-24	24mm	120#
T.BW.S0025-14	14mm	220#
T.BW.S0025-19	19mm	220#
T.BW.S0025-24	24mm	220#
T.BW.S0024-14	14mm	320#
T.BW.S0024-19	19mm	320#
T.BW.S0024-24	24mm	320#
T.BW.S0037-14	14mm	400#
T.BW.S0037-19	19mm	400#
T.BW.S0037-24	24mm	400#
T.BW.S0036-14	14mm	600#
T.BW.S0036-19	19mm	600#
T.BW.S0036-24	24mm	600#
T.BW.S0026-14	14mm	1000#
T.BW.S0026-19	19mm	1000#
T.BW.S0026-24	24mm	1000#
T.BW.S0049-14	14mm	2500#
T.BW.S0049-19	19mm	2500#
T.BW.S0049-24	24mm	2500#

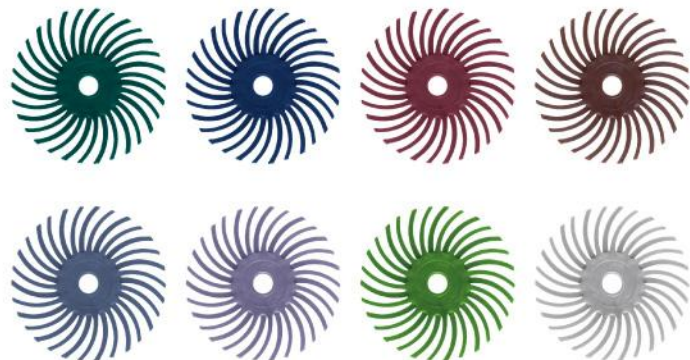

拉丝轮 (没夹砂)  
Wire drawing wheel

代码 Model	直径 Diameter	厚度 Thickness	目数 Mesh count
T.BW.LS001	120mm	100mm	60#
T.BW.LS002	120mm	100mm	80#
T.BW.LS003	120mm	100mm	120#
T.BW.LS004	120mm	100mm	240#
T.BW.LS005	120mm	100mm	320#
T.BW.LS006	120mm	100mm	60#
T.BW.LS007	120mm	100mm	80#
T.BW.LS008	120mm	100mm	60#
T.BW.LS009	120mm	100mm	80#



拉丝轮 (夹砂)  
Wire drawing wheel with sanding

代码 Model	直径 Diameter	厚度 Thickness	目数 Mesh count
T.BW.LS008	120mm	100mm	60#
T.BW.LS009	120mm	100mm	80#



拉丝轮 (进口料)  
Wire drawing wheel imported

代码 Model	直径 Diameter	厚度 Thickness	目数 Mesh count
T.BW.LS010	120mm	100mm	60#
T.BW.LS011	120mm	100mm	80#
T.BW.LS012	120mm	100mm </td <td>60#</td>	60#
T.BW.LS013	120mm	100mm	80#



拉丝轮 (全砂布)  
Wire drawing wheel full sanding

代码 Model	直径 Diameter	厚度 Thickness	目数 Mesh count
T.BW.LS014	120mm	100mm	60#
T.BW.LS015	120mm	100mm	80#
T.BW.LS016	120mm	100mm	120#
T.BW.LS017	120mm	100mm	180#
T.BW.LS018	120mm	100mm	240#

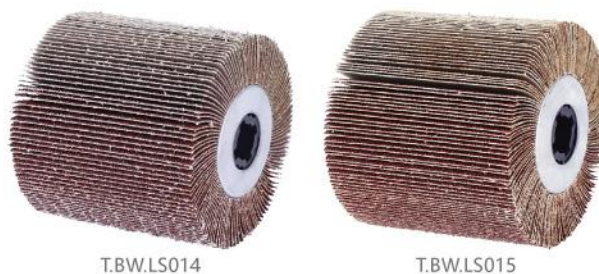

气动拉丝轮

Pneumatic wire drawing wheel

代码 Model	直径 Diameter	厚度 Thickness	目数 Mesh count
T.BW.LS019	120mm	50mm	60#
T.BW.LS020	120mm	50mm	80#
T.BW.LS021	120mm	50mm <td 60#	
T.BW.LS022	120mm	50mm	80#



3M黑金钢拉丝轮

3M black steel wire drawing wheel

代码 Model	直径 Diameter	厚度 Thickness	目数 Mesh count
T.BW.LS023	120mm	100mm	-



金刚石切割片

Diamond cutter

代码 Model	直径 Diameter	中心孔 Centre Hole	厚度 Thickness
T.BW.S0014	16mm	3mm	0.6mm
T.BW.S0013	18mm	3mm	0.6mm
T.BW.S0012	20mm	3mm	0.6mm
T.BW.S0001	22mm	3mm	0.6mm
T.BW.S0011	25mm	3mm	0.6mm
T.BW.S0010	30mm	3mm	0.6mm
T.BW.S0002	35mm	3mm	0.6mm
T.BW.S0007	40mm	3mm	0.6mm
T.BW.S0009	45mm	3mm	0.6mm
T.BW.S0008	50mm	3mm	0.6mm
T.BW.S0070	60mm	3mm	0.6mm



T.BW.S0014



T.BW.S0013



T.BW.S0012



T.BW.S0011



T.BW.S0010



T.BW.S0008

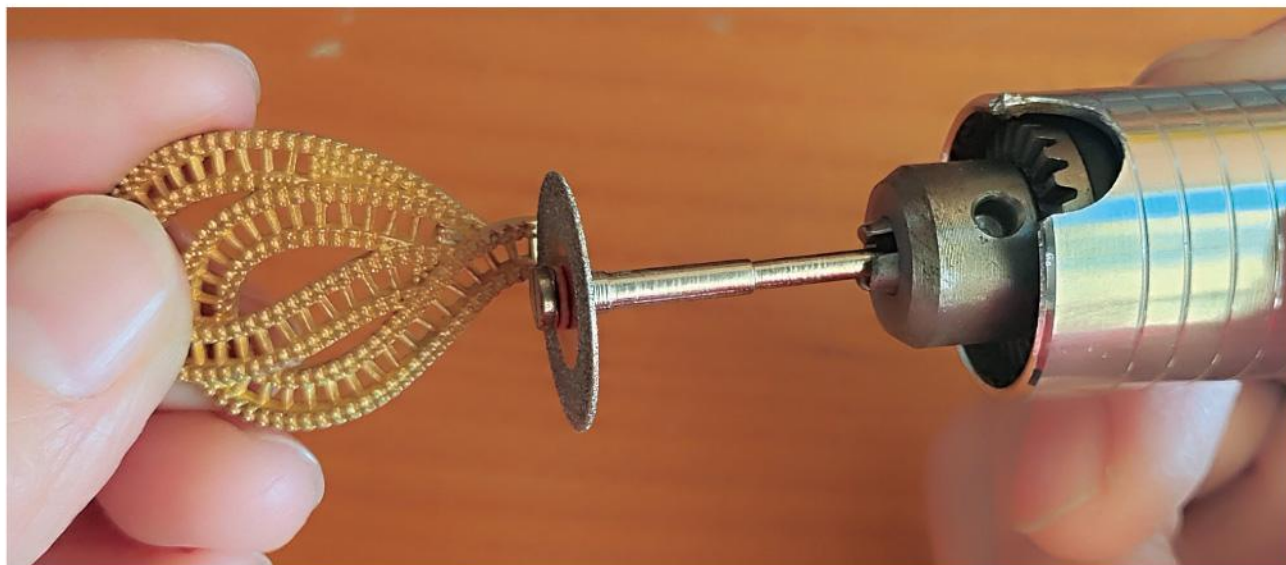

金刚石切割片  
Diamond cutter

代码 Model	直径 Diameter	中心孔 Centre Hole	厚度 Thickness
A T.BW.S0071	20mm	3mm	0.6mm
B T.BW.S0072	25mm	3mm	0.6mm
C T.BW.S0073	30mm	3mm	0.6mm
D T.BW.S0074	35mm	3mm	0.6mm
E T.BW.S0075	40mm	3mm <td 0.6mm	
F T.BW.S0076	50mm	3mm	0.6mm
G T.BW.S0077	50mm	3mm	0.6mm
H T.BW.S0078	60mm	3mm	0.6mm



金刚石切割片  
Diamond cutter

代码 Model	直径 Diameter	中心孔 Centre Hole	厚度 Thickness
T.BW.S0079	60mm	16mm	0.6mm
T.BW.S0080	100mm	20mm	1mm



超薄金刚石树脂切割片  
Ultra-thin diamond resin cutter

代码 Model	直径 Diameter	中心孔 Centre Hole	厚度 Thickness
T.BW.S0100	100mm	20mm	1mm
T.BW.S0101	156mm	31.75mm	0.8mm
T.BW.S0102	159mm	32mm	1mm
T.BW.S0103	200mm	31.75mm	1.1mm
T.BW.S0104	125mm	31.75mm	1mm



红色大理石切割片  
Red marble cutter

代码 Model	直径 Diameter	中心孔 Centre Hole	厚度 Thickness
T.BW.S0105	110mm	20mm	1.1~1.5mm



### 太阳砂纸 SUNMTCHT Sanding paper

代码 Model	尺寸 Size	目数 Mesh count
T.PPTY0120	230×280mm	120#
T.PPTY0180	230×280mm	180#
T.PPTY0240	230×280mm	240#
T.PPTY0320	230×280mm	320#
T.PPTY0400	230×280mm	400#
T.PPTY0600	230×280mm	600#
T.PPTY0800	230×280mm	800#



100 Pcs/Pack, 5 Packs/Box

### 德国勇士砂纸 STARCKE Sanding paper

代码 Model	尺寸 Size	目数 Mesh count
T.PPYS0180	230×280mm	180#
T.PPYS0220	230×280mm	220#
T.PPYS0240	230×280mm	240#
T.PPYS0280	230×280mm	280#
T.PPYS0320	230×280mm	320#
T.PPYS0400	230×280mm	400#
T.PPYS0600	230×280mm	600#
T.PPYS0800	230×280mm	800#
T.PPYS1000	230×280mm	1000#
T.PPYS1200	230×280mm	1200#
T.PPYS1500	230×280mm	1500#
T.PPYS2000	230×280mm	2000#
T.PPYS2500	230×280mm	2500#
T.PPYS3000	230×280mm	3000#
T.PPYS5000	230×280mm	5000#
T.PPYS7000	230×280mm	7000#



100 Pcs/Pack, 5 Packs/Box

### SAIHUI砂纸 SAIHUI Sanding paper

代码 Model	尺寸 Size	目数 Mesh count
T.PPL0060-B	230×280mm	60#
T.PPL0080-B	230×280mm	80#
T.PPL0120-B	230×280mm	120#
T.PPL0150-B	230×280mm	150#
T.PPL0180-B	230×280mm	180#
T.PPL0240-B	230×280mm	240#
T.PPL0320-B	230×280mm	320#
T.PPL0400-B	230×280mm	400#
T.PPL0600-B	230×280mm	600#
T.PPL0800-B	230×280mm	800#



100 Pcs/Pack, 5 Packs/Box

砂带  
Sanding belt

代码 Model	尺寸 Size	目数 Mesh count
T.BW.SD040-C	90×100mm	40#
T.BW.SD060-C	90×100mm	60#
T.BW.SD080-C	90×100mm	80#
T.BW.SD100-C	90×100mm	100#
T.BW.SD120-C	90×100mm	120#
T.BW.SD150-C	90×100mm	150#
T.BW.SD180-C	90×100mm	180#
T.BW.SD240-C	90×100mm	240#
T.BW.SD320-C	90×100mm	320#
T.BW.SD400-C	90×100mm	400#
T.BW.SD600-C	90×100mm	600#
T.BW.SD040-A	610×100mm	40#
T.BW.SD060-A	610×100mm	60#
T.BW.SD080-A	610×100mm	80#
T.BW.SD100-A	610×100mm	100#
T.BW.SD120-A	610×100mm	120#
T.BW.SD150-A	610×100mm	150#
T.BW.SD180-A	610×100mm	180#
T.BW.SD240-A	610×100mm	240#
T.BW.SD320-A	610×100mm	320#
T.BW.SD400-A	610×100mm	400#
T.BW.SD600-A	610×100mm	600#
T.BW.SD040	50×700mm	40#
T.BW.SD060	50×700mm	60#
T.BW.SD080	50×700mm	80#
T.BW.SD100	50×700mm	100#
T.BW.SD120	50×700mm	120#
T.BW.SD150	50×700mm	150#
T.BW.SD180	50×700mm	180#
T.BW.SD240	50×700mm	240#
T.BW.SD320	50×700mm	320#
T.BW.SD400	50×700mm	400#
T.BW.SD600	50×700mm	600#

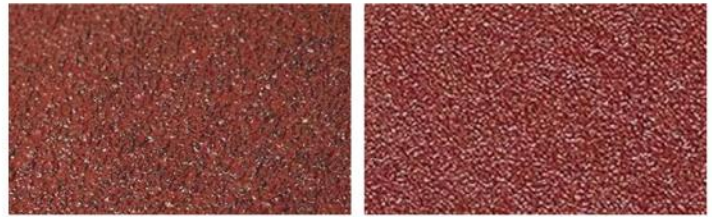

40#

60#



100#

120#

150#



180#

240#

砂纸棒  
Sand paper rod

代码 Model	直径 Diameter	长度 Length	铁杆直径 Rod Diameter
T.CG.00218-320	12mm	48mm	2.35mm
T.CG.00218-400	12mm	48mm	2.35mm
T.CG.00218-600	12mm	48mm	2.35mm
T.CG.00218-800	12mm	48mm	2.35mm
T.CG.00218-1000	12mm	48mm	2.35mm
T.CG.00218-1200	12mm	48mm	2.35mm
T.CG.00218-1500	12mm	48mm	2.35mm
T.CG.00218-2000	12mm	48mm	2.35mm
T.CG.00218-2500	12mm	48mm	2.35mm
T.CG.00218-3000	12mm	48mm	2.35mm
T.CG.00218-5000	12mm	48mm	2.35mm
T.CG.00218-7000	12mm	48mm	2.35mm



包装 Package: 100 Pcs/Pack 100 Pack/Carton

飞碟夹  
Split lap clamp

代码 Model	尺寸 Size
A T.BW.JB002	Φ2.35×42.5mm
B T.BW.JB003	Φ3.0×5×44mm
C T.BW.JB017	Φ4×7×46mm
D T.BW.JB005	Φ2.35×5×44mm
E T.BW.JB016	Φ2.35×8×47mm
F T.BW.JB004	Φ2.0mm
G T.BW.JB018	Φ3.0mm



夹砂棒  
Rod

代码 Model	尺寸 Size	槽宽 Groove width
A T.BW.JB009	Φ2.35×50mm	0.5×17mm
B T.BW.JB019	Φ3×50mm	0.5×17mm
C T.BW.JB014	Φ4×50mm	0.5×17mm
D T.BW.JB013	Φ5×Φ2.35×50mm	0.6×17mm
E T.BW.JB008	Φ2.35×50mm	0.5×17mm

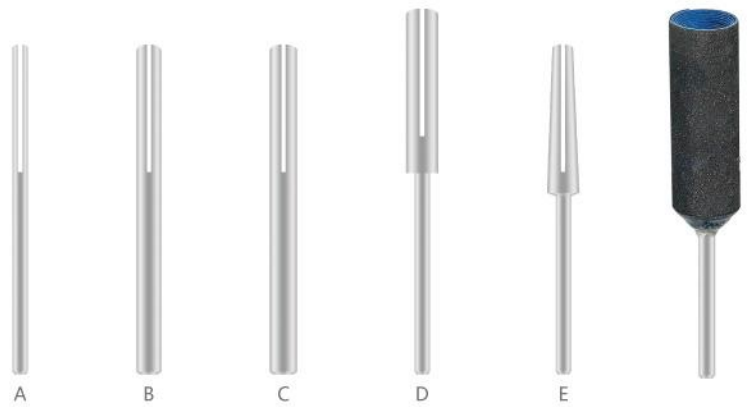

玛瑙刀  
Agate knife

代码 Model	刀长 Knife length	柄长 Handle length
T.SB.00054-A	40mm	180mm
T.SB.00054-B	40mm	180mm
T.SB.00054-C	40mm	95mm
T.SB.00054-D	40mm	145mm



玛瑙刀  
Agate knife

代码 Model	刀长 Knife length	代码 Model	刀长 Knife length
T.SB.00052-8	80mm	T.SB.00052-15	150mm
T.SB.00052-9	90mm	T.SB.00052-16	160mm
T.SB.00052-10	100mm	T.SB.00052-17	170mm
T.SB.00052-11	110mm	T.SB.00052-18	180mm
T.SB.00052-12	120mm	T.SB.00052-19	190mm
T.SB.00052-13	130mm	T.SB.00052-20	200mm
T.SB.00052-14	140mm		

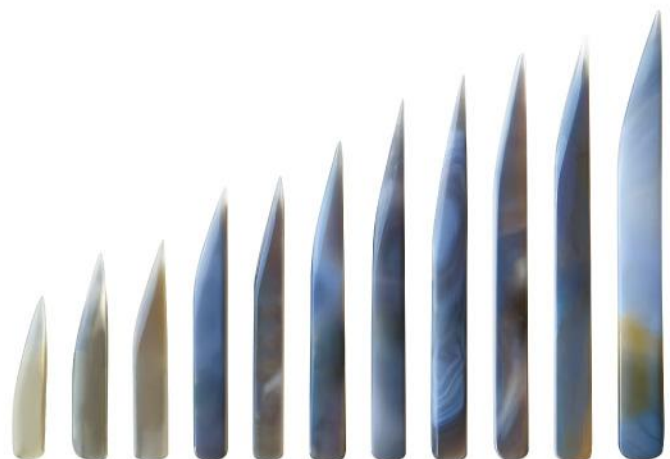

钢压  
Steel burnisher

代码 Model	Φ1	Φ2	L1	L2	形状 Shape
T.TS.G0013	2mm	5mm	22mm	220mm	常规 Routine
T.TS.G0004	2mm	5mm	22mm	220mm	加细 Tiny
T.TS.G0020	2mm	5mm	22mm	220mm	特细 Very detailed
T.TS.G0030	2mm	5mm	22mm	220mm	异形 Special-shaped
T.TS.G0008-B	3mm	5mm	20mm	165mm	常规 Routine
T.TS.G0006	3mm	5mm	20mm	165mm	加细 Tiny
T.TS.G0031	3mm	5mm	20mm	165mm	特细 Very detailed
T.TS.G0032	3mm	5mm	20mm	165mm	异形 Special-shaped
T.TS.G0033	3mm	5mm	20mm	165mm	异形 Special-shaped
T.TS.G0008	3mm	6mm	35mm	220mm	常规 Routine
T.TS.G0005	3mm	6mm	35mm	220mm	加细 Tiny
T.TS.G0017	3mm	6mm	35mm	220mm	特细 Very detailed
T.TS.G0027	3mm	6mm	35mm	220mm	异形 Special-shaped
T.TS.G0034	3mm	6mm	35mm	220mm	异形 Special-shaped
T.TS.G0035	3mm	6mm	35mm	220mm	异形 Special-shaped
T.TS.G0036	3mm	6mm	35mm	220mm	异形 Special-shaped
T.TS.G0037	3mm	6mm	35mm	220mm	异形 Special-shaped
T.TS.G0009	4mm	7mm	35mm	220mm	常规 Routine
T.TS.G0007	4mm	7mm	35mm	220mm	加细 Tiny
T.TS.G0021	4mm	7mm	35mm	220mm	特细 Very detailed
T.TS.G0018	4mm	7mm	35mm	220mm	异形 Special-shaped
T.TS.G0038	4mm	7mm	35mm	220mm	异形 Special-shaped

代码 Model	Φ1	Φ2	L1	L2	形状 Shape
T.TS.G0039	4mm	7mm	35mm	220mm	异形 Special-shaped
T.TS.G0040	4mm	7mm	35mm	220mm	异形 Special-shaped
T.TS.G0041	4mm	7mm	35mm	220mm	异形 Special-shaped
T.TS.G0042	4mm	7mm	35mm	220mm	异形 Special-shaped
T.TS.G0010	5mm	8mm	35mm	220mm	常规 Routine
T.TS.G0010-B	5mm	8mm	35mm	220mm	加细 Tiny
T.TS.G0043	5mm	8mm	35mm	220mm	特细 Very detailed
T.TS.G0025	5mm	8mm	35mm	220mm	异形 Special-shaped
T.TS.G0044	5mm	8mm	35mm	220mm	异形 Special-shaped
T.TS.G0045	5mm	8mm	35mm	220mm	异形 Special-shaped
T.TS.G0011	6mm	9mm	36mm	220mm	常规 Routine
T.TS.G0046	6mm	9mm	36mm	220mm	加细 Tiny
T.TS.G0047	6mm	9mm	36mm	220mm	特细 Very detailed
T.TS.G0048	6mm	9mm	36mm	220mm	异形 Special-shaped
T.TS.G0049	6mm	9mm	36mm	220mm	异形 Special-shaped
T.TS.G0050	6mm	9mm	36mm	220mm	异形 Special-shaped
T.TS.G0051	4mm	7mm	35mm	220mm	异形 Special-shaped
T.TS.G0052	5mm	8mm	35mm	220mm	异形 Special-shaped
T.TS.G0053	6mm	9mm	36mm	220mm	异形 Special-shaped
T.TS.G0054	4mm	7mm	35mm	220mm	异形 Special-shaped
T.TS.G0055	5mm	8mm	35mm	220mm	异形 Special-shaped
T.TS.G0056	6mm	9mm	36mm	220mm	异形 Special-shaped





T.TS.G0037

T.TS.G0009

T.TS.G0007

T.TS.G0021

T.TS.G0018

T.TS.G0038

T.TS.G0039

T.TS.G0040

T.TS.G0041

T.TS.G0042

T.TS.G0010

T.TS.G0010-B

T.TS.G0043

T.TS.G0025

T.TS.G0044

T.TS.G0045

T.TS.G0011

T.TS.G0046

T.TS.G0047

T.TS.G0048

T.TS.G0049

T.TS.G0050

T.TS.G0051, T.TS.G0052, T.TS.G0053

T.TS.G0054, T.TS.G0055, T.TS.G0056



T.TS.G0027-C 异形 Special-shaped



厚推木  
Sanding wood  
T.CG.00236-1



薄推木  
Sanding wood  
T.CG.00236-2



铝砂纸夹  
Aluminium sanding wood  
T.CG.00154 265×25×5mm



铝砂纸夹  
Aluminium sanding wood  
T.CG.00155 265×20×5mm



钻石砂针  
Diamond drill  
T.CG.SZ036



钻石砂针  
Diamond drill  
T.CG.SZ036-B



钻石砂针  
Diamond drill  
T.CG.SZ037

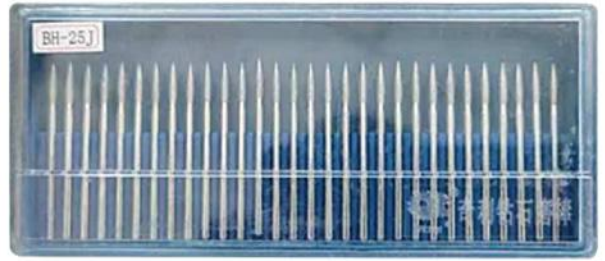

钻石砂针(米粒形)  
Diamond drill  
T.CG.SZ019



钻石砂针(尖)  
Pointed diamond drill

代码 Model	规格 Specifications
T.CG.SZ014	0.5D
T.CG.SZ015	0.6D
T.CG.SZ017	0.8D

100 Pcs/Pack



钻石砂针(圆)3.0F  
Pointed diamond drill 3.0F  
T.CG.SZ018



钻石砂针(圆柱形)  
Pointed diamond drill  
T.CG.SZ065

钻石砂针(圆柱形)  
Pointed diamond drill

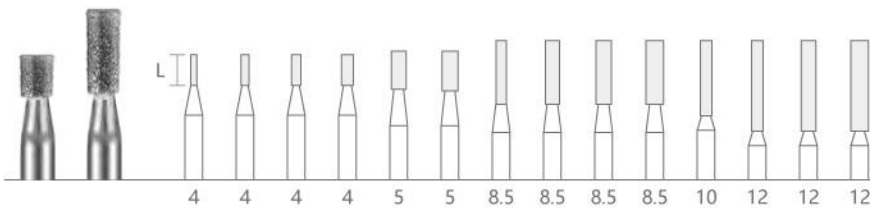

代码 Model	L	直径 Diameter
T.CG.SZ066-4-10	4mm	Φ1.0mm
T.CG.SZ066-4-12	4mm	Φ1.2mm
T.CG.SZ066-4-14	4mm	Φ1.4mm
T.CG.SZ066-4-16	4mm	Φ1.6mm
T.CG.SZ068-1	5mm	Φ1.8mm
T.CG.SZ068-2	5mm	Φ2.1mm
T.CG.SZ042-1	8.5mm	Φ1.5mm
T.CG.SZ042-2	8.5mm	Φ1.8mm
T.CG.SZ042-3	8.5mm	Φ2.1mm
T.CG.SZ042-4	8.5mm	Φ2.3mm
T.CG.SZ066-1	10mm	Φ1.6mm
T.CG.SZ066-2	12mm	Φ1.8mm
T.CG.SZ066-3	12mm	Φ2.1mm
T.CG.SZ066-4	12mm	Φ2.3mm

金刚砂针(倒造型)  
Taper diamond drill

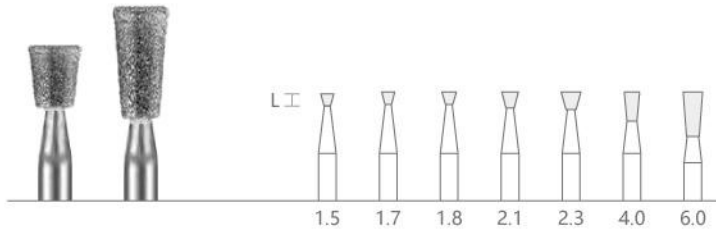

代码 Model	L	直径 Diameter
T.CG.SZ041-1	1.5mm	Φ1.4mm
T.CG.SZ041-2	1.7mm	Φ1.6mm
T.CG.SZ041-3	1.8mm	Φ1.8mm
T.CG.SZ041-4	2.1mm	Φ2.1mm
T.CG.SZ041-5	2.3mm	Φ2.3mm
T.CG.SZ041-6	4.0mm	Φ1.6mm
T.CG.SZ041-7	6.0mm	Φ2.3mm

金刚砂针(尖)  
Pointed diamond drill

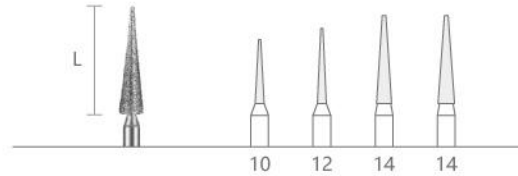

代码 Model	L	直径 Diameter
T.CG.SZ039	14mm	Φ2.3mm
T.CG.SZ039-2	10mm	Φ1.4mm
T.CG.SZ039-3	12mm	Φ1.8mm
T.CG.SZ039-4	14mm	Φ2.0mm

金刚砂针(圆)  
Round diamond drill

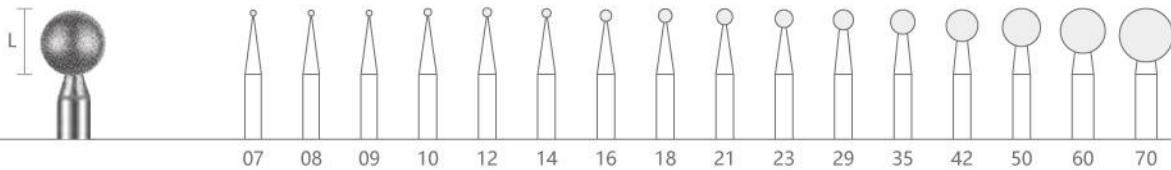

代码 Model	直径 Diameter
T.CG.SZ040-10	Φ1.0mm
T.CG.SZ040-11	Φ1.1mm
T.CG.SZ040-12	Φ1.2mm
T.CG.SZ040-13	Φ1.3mm
T.CG.SZ040-14	Φ1.5mm
T.CG.SZ040-06	Φ0.6mm
T.CG.SZ040-07	Φ0.7mm
T.CG.SZ040-08	Φ0.8mm
T.CG.SZ040-09	Φ0.9mm
T.CG.SZ040-14	Φ1.4mm
T.CG.SZ040-16	Φ1.6mm
T.CG.SZ040-17	Φ1.7mm
T.CG.SZ040-18	Φ1.8mm
T.CG.SZ040-19	Φ1.9mm
T.CG.SZ040-20	Φ2.0mm
T.CG.SZ040-21	Φ2.1mm
T.CG.SZ040-22	Φ2.2mm
T.CG.SZ040-23	Φ2.3mm
T.CG.SZ040-24	Φ2.4mm
T.CG.SZ040-25	Φ2.5mm
T.CG.SZ040-26	Φ2.6mm
T.CG.SZ040-27	Φ2.7mm

代码 Model	直径 Diameter
T.CG.SZ040-28	Φ2.8mm
T.CG.SZ040-29	Φ2.9mm
T.CG.SZ040-30	Φ3.0mm
T.CG.SZ040-31	Φ3.1mm
T.CG.SZ040-32	Φ3.2mm
T.CG.SZ040-33	Φ3.3mm
T.CG.SZ040-34	Φ3.4mm
T.CG.SZ040-35	Φ3.5mm
T.CG.SZ040-36	Φ3.6mm
T.CG.SZ040-37	Φ3.7mm
T.CG.SZ040-38	Φ3.8mm
T.CG.SZ040-39	Φ3.9mm
T.CG.SZ040-40	Φ4.0mm
T.CG.SZ040-41	Φ4.1mm
T.CG.SZ040-42	Φ4.2mm
T.CG.SZ040-43	Φ4.3mm
T.CG.SZ040-44	Φ4.4mm
T.CG.SZ040-45	Φ4.5mm
T.CG.SZ040-46	Φ4.6mm
T.CG.SZ040-47	Φ4.7mm
T.CG.SZ040-48	Φ4.8mm
T.CG.SZ040-49	Φ4.9mm

代码 Model	直径 Diameter
T.CG.SZ040-50	Φ5.0 mm
T.CG.SZ040-51	Φ5.1mm
T.CG.SZ040-52	Φ5.2mm
T.CG.SZ040-53	Φ5.3mm
T.CG.SZ040-54	Φ5.4mm
T.CG.SZ040-55	Φ5.5mm
T.CG.SZ040-56	Φ5.6mm
T.CG.SZ040-57	Φ5.7mm
T.CG.SZ040-58	Φ5.8mm
T.CG.SZ040-59	Φ5.9mm
T.CG.SZ040-60	Φ6.0mm
T.CG.SZ040-61	Φ6.1mm
T.CG.SZ040-62	Φ6.2mm
T.CG.SZ040-63	Φ6.3mm
T.CG.SZ040-64	Φ6.4mm
T.CG.SZ040-65	Φ6.5mm
T.CG.SZ040-66	Φ6.6mm
T.CG.SZ040-67	Φ6.7mm
T.CG.SZ040-68	Φ6.8mm
T.CG.SZ040-69	Φ6.9mm
T.CG.SZ040-70	Φ7.0mm

金刚砂针(倒追型)  
Taper diamond drill

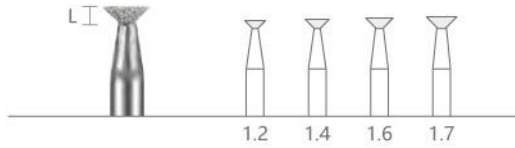

代码 Model	L	直径 Diameter
T.CG.SZ044-1	1.2mm	Φ2.5mm
T.CG.SZ044-2	1.4mm	Φ3.0mm
T.CG.SZ044-3	1.6mm	Φ3.5mm
T.CG.SZ044-4	1.7mm	Φ4.0mm

金刚砂针(顺锥形)  
Taper diamond drill

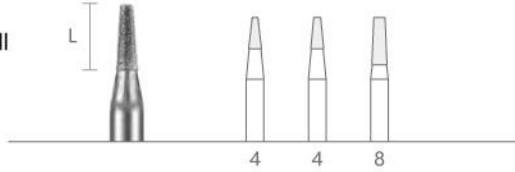

代码 Model	L	直径 Diameter
T.CG.SZ045-1	4mm	Φ1.6mm
T.CG.SZ045-2	4mm	Φ1.8mm
T.CG.SZ045-3	8mm	Φ2.3mm

金刚砂针(倒追型)  
Taper diamond drill

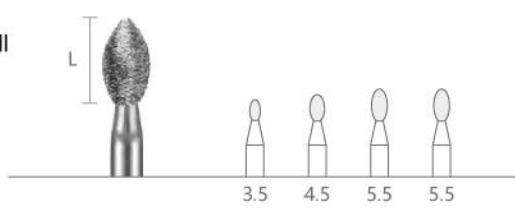

代码 Model	L	直径 Diameter
T.CG.SZ046-1	3.5mm	Φ1.6mm
T.CG.SZ046-2	4.5mm	Φ2.1mm
T.CG.SZ046-3	5.5mm	Φ2.3mm
T.CG.SZ046-4	5.5mm	Φ2.5mm

旋转锉  
Rotary file



3×4 双槽套装  
3×4 Double slot set  
T.BW.MTQT02-1



3×4 单槽套装  
3×4 Single slot set  
T.BW.MTQT02-2



3×4 单槽宽齿套装  
3×4 Single slot wide tooth set  
T.BW.MTQT02-3



3×6 双槽套装  
3×6 Double slot set  
T.BW.MTQT01-1



3×6 单槽套装  
3×6 Single slot set  
T.BW.MTQT01-2



3×6 单槽宽齿套装  
3×6 Single slot wide tooth set  
T.BW.MTQT01-3

旋转锉(3×4双槽套装)  
Rotary file (3×4 Double Slot Set)

代码 Model	总长 Total length	柄直径 Handle diameter	刃径 Blade diameter	刃长 Blade length
A T.BW.MTQT02-4	50mm	Φ3mm	6mm	13mm
C T.BW.MTQT02-5	50mm	Φ3mm	6mm	13mm
D T.BW.MTQT02-6	50mm	Φ3mm	6mm	13mm
E T.BW.MTQT02-7	50mm	Φ3mm	6mm	13mm
F T.BW.MTQT02-8	50mm	Φ3mm	6mm	13mm
G T.BW.MTQT02-9	50mm	Φ3mm	6mm	13mm
H T.BW.MTQT02-10	50mm	Φ3mm	6mm	13mm
L T.BW.MTQT02-11	50mm	Φ3mm	6mm	13mm
M T.BW.MTQT02-12	50mm	Φ3mm	6mm	13mm
N T.BW.MTQT02-13	50mm	Φ3mm	6mm	13mm



包装 Package: 10 Pcs/Box

旋转锉(3×6双槽套装)  
Rotary file ((3×6 Double Slot Set)

代码 Model	总长 Total length	柄直径 Handle diameter	刃径 Blade diameter	刃长 Blade length
A T.BW.MTQT01-4	50mm	Φ3mm	6mm	13mm
C T.BW.MTQT01-5	50mm	Φ3mm	6mm	13mm
D T.BW.MTQT01-6	50mm	Φ3mm	6mm	13mm
E T.BW.MTQT01-7	50mm	Φ3mm	6mm	13mm
F T.BW.MTQT01-8	50mm	Φ3mm	6mm	13mm
G T.BW.MTQT01-9	50mm	Φ3mm	6mm	13mm
H T.BW.MTQT01-10	50mm	Φ3mm	6mm	13mm
L T.BW.MTQT01-11	50mm	Φ3mm	6mm	13mm
M T.BW.MTQT01-12	50mm	Φ3mm	6mm	13mm
N T.BW.MTQT01-13	50mm	Φ3mm	6mm	13mm



包装 Package: 10 Pcs/Box

戒指绒棒  
Felt ring buff

代码 Model	名称 Description	直径 Diameter	长度 Length
T.BW.L0014	戒指绒棒3寸小 3" felt ring buff-small	Φ18mm	112mm
T.BW.L0015	戒指绒棒3寸中 3" felt ring buff-medium	Φ19mm	112mm
T.BW.L0016	戒指绒棒3寸大 3" felt ring buff-large	Φ20mm	112mm
T.BW.L0017	戒指绒棒4寸 4" felt ring buff	Φ23mm	132mm
T.BW.L0019	戒指绒棒5寸 5" felt ring buff	Φ26mm	152mm



手镯棒/手镯内抛棍  
Felt bange buff

代码 Model	Φ1	Φ2	L
T.BW.L0020	Φ50mm	Φ23mm	90mm

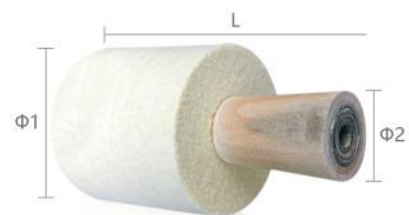

木柄铜丝刷

Rows brass wire brush with handle

代码 Model	铜丝直径 Diameter	铜丝长度 Length	排数 Row Number
T.BW.MS003-3	0.08mm	19mm	3
T.BW.MS003-4	0.08mm	19mm	4
T.BW.MS003-5	0.08mm	19mm	5
T.BW.MS003-6	0.08mm	19mm	6
T.BW.MS003-8	0.08mm	19mm	8
T.BW.MS003-10	0.08mm	19mm	10



包装 Package: 6 Pcs/Box 16 Boxes/Carton

木柄铜丝刷

Rows brass wire brush with handle

代码 Model	铜丝直径 Diameter	铜丝长度 Length	排数 Row Number
T.BW.MS004-3	0.08mm	19mm	3
T.BW.MS004-4	0.08mm	19mm	4
T.BW.MS004-5	0.08mm	19mm	5
T.BW.MS004-6	0.08mm	19mm	6
T.BW.MS004-8	0.08mm	19mm	8
T.BW.MS004-10	0.08mm	19mm	10



包装 Package: 6 Pcs/Box 16 Boxes/Carton

油漆刷

Paint brush

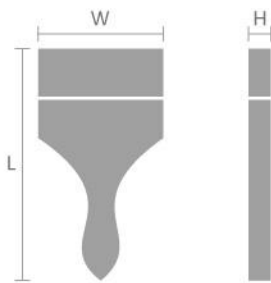

代码 Model	尺寸 Size	L	W	H
T.BW.D0030	1"	180mm	25mm	14mm
T.BW.D0031	2"	200mm	50mm	14mm
T.BW.D0036	2.5"	195mm	65mm	14mm
T.BW.D0032	3"	205mm	75mm	14mm
T.BW.D0033	4"	225mm	100mm	14mm
T.BW.D0034	5"	220mm	125mm	19mm
T.BW.D0037	6"	230mm	150mm	19mm

**防酸手套**  
Acid proof glove

采用橡胶制成，对多种化学溶剂有良好的防护作用，耐弱酸碱，防水防油，卷边设计，可防少量水倒流弄湿衣服。

Made of rubber, it has good protection against various chemical solvents, is resistant to weak acid and alkali, waterproof and oil resistant, with a rolled edge design that can prevent a small amount of water from flowing back and wetting clothes.



35cm T.HP.00028



45cm T.HP.00029



55cm T.HP.00029

**防护手套**  
High temp glove

采用优质牛皮制成，磨砂质感防脱落，具有防火耐磨隔热的性能，适合焊接、倒模、切割打磨等。

Made of high-quality cowhide, with a frosted texture and anti shedding properties, it has fire-resistant, wear-resistant, and heat-insulating properties, suitable for welding, molding, cutting, and polishing.



35cm T.HP.00025



40cm T.HP.0002M



45cm T.HP.0002L

**防护服**  
Protective clothing

采用优质牛皮，具有很好的防护功能，耐磨，耐高温防火花飞溅，经久耐穿，适合电焊工，氩弧焊工穿着。

Made of high-quality cowhide, it has excellent protective function, wear resistance, high temperature resistance, fire splash resistance, and durability, suitable for electric welders and argon arc welders to wear.

T.HP.00004



一次性防护口罩  
Disposable protective mask

T.HP.00037



棉手套  
Cotton gloves  
T.HP.00018



线手套  
Line gloves  
T.HP.00019



胶手指套  
Plastic finger guard  
T.HP.00024



黄色胶手指套  
Yellow plastic finger guard  
T.HP.00022



防滑手指套  
non-slip plastic finger guard  
T.HP.00036



牛皮手指套  
Leather finger guard  
T.HP.00020



羊皮手指套  
Sheepskin finger guard  
T.HP.00021



棉手指套(加厚)  
Thicken cotton finger guard  
T.HP.00023



线手指套  
Knitting finger guard  
T.HP.00027



毛巾  
Towel  
T.CG.00018 300×600mm



厚毛巾  
Thick towel  
T.CG.00055 300×660mm



加厚毛巾  
Thickened towel  
T.CG.00185 350×750mm



抛光粉  
Polishing powder  
T.PW.PGG01 T.PW.PGG36-4  
T.PW.PGG36-6 T.PW.PGG42



防锈粉  
Rust-removal powder  
T.PW.PGG14



白矾  
Alum  
H.PD.00006



硼酸粉  
Boric acid powder  
H.PD.00041

干打砂机  
Dry sand-making machine



M.SP.00012



M.SP.00015



M.SP.00019

型号 Model	M.SP.00012	M.SP.00015	M.SP.00019
电压 Voltage	220V	220V	220V
功率 Power	0.02KW	300W	800W
尺寸 Size	800×550×1150mm	900×600×1700mm	1010×1270×1750mm
重量 Weight	52KG	100KG	150KG

## 喷砂机 Sanding blasting machine

可干喷湿喷，金属、亚克力、塑料喷砂处理，达到磨砂、抛光效果。  
It could make dry spray and wet spray, metal, acrylic, and plastic sandblasting treatment to achieve frosted and polished results.



M.SP.00001



M.SP.00001-2



M.SP.00006



M.SP.00005

型号 Model	M.SP.00001	M.SP.00001-2	M.SP.00006	M.SP.00005
电压 Voltage	220V	220V	220V	220V
功率 Power	40W	40W	100W	100W
尺寸 Size	420×350×500mm	420×350×500mm	570×420×700mm	570×420×1400mm
重量 Weight	8KG	8KG	18KG	18KG



M.SP.00002



M.SP.00002-A  
不带雨刮  
Without wiper



M.SP.00002-B  
带变频，带温控  
With frequency conversion and  
temperature controller



M.SP.00004

型号 Model	M.SP.00002	M.SP.00002-A	M.SP.00002-B	M.SP.00004
电压 Voltage	220V	220V	220V	220V
功率 Power	1.1KW	1.1KW	1.1KW	1.1KW
尺寸 Size	500×600×1200mm	500×600×1200mm	500×600×1200mm	700×700×1600mm
重量 Weight	25KG	25KG	25KG	40KG



双笔喷砂机PS-7  
Double-pen sanding blasting machine PS-7

型号 Model: M.SP.00009  
尺寸 Size: 490×410×360mm  
重量 Weight: 10KG



万能粗细喷砂机PS-A  
Universal thick and thin sanding blasting machine PS-A

型号 Model: M.SP.00010  
尺寸 Size: 540×510×390mm  
重量 Weight: 18KG



喷砂机PS-B  
Sanding blasting machine PS-B

型号 Model: M.SP.00011  
尺寸 Size: 490×400×360mm  
重量 Weight: 10KG

金刚砂  
Emery

型号 Model	砂度 Sandness	包装 Package
H.PD.00048-1	细 Thin 70/80#	1kg/瓶/Box
H.PD.00048	细 Thin 80/100#	1kg/瓶/Box
H.PD.00043	中 Medium 40/50#	1kg/瓶/Box
H.PD.00044	中 Medium 50/60#	1kg/瓶/Box
H.PD.00051	粗 Thick 30/35#	1kg/瓶/Box
H.PD.00046	粗 Thick 35/40#	1kg/瓶/Box



型号 Model	名称 Designation	目数 Mesh count	包装 Package
H.PD.00061	玻璃砂 Glass sand	30#	50磅/包 50 lbs/Pack
H.PD.00042		60#	
H.PD.00049		80#	
H.PD.00054		100#	
H.PD.00032		120#	
H.PD.00033		150#	
H.PD.00015		180#	
H.PD.00020		220#	
H.PD.00013		280#	
H.PD.00014		320#	
H.PD.00042-B	古法砂 Ancient type sand	60#	5公斤/桶 5kg/Barrel
H.PD.00049-B		80#	
H.PD.00054-B		100#	
H.PD.00032-B		120#	
H.PD.00033-B		150#	
H.PD.00015-C		180#	
H.PD.00020-B		220#	
H.PD.00013-B		280#	
H.PD.00014-B	320#		



喷砂前  
Before sandblasting



喷砂后  
After sandblasting

### 雕刻机 Graving machine

型号 Model	M.MF.K0001
电压 Voltage	220V 50Hz/110V 60Hz
手动工作速度 Handpiece working speed	400-8000 RPM
压力调节范围 Range of pressure regulation	0-45 PSI
尺寸 Size	270×140×225mm
重量 Weight	7kg



型号 Model	M.MF.K0003
电压 Voltage	220V 50Hz/110V 60Hz
手动工作速度 Handpiece working speed	400-8000 RPM
压力调节范围 Range of pressure regulation	0-60 PSI
尺寸 Size	290×130×210mm
重量 Weight	9kg



型号 Model	M.MF.K0004
电源 Voltage	220V 50Hz/110V 60Hz
手动工作速度 Handpiece working speed	400-8000 RPM
压力调节范围 Range of pressure regulation (脚踏控制 Foot control)	0-60 PSI
压力调节范围 Range of pressure regulation (脚踏控制 Foot control)	0-60 PSI
尺寸 Size	292×150×206mm
重量 Weight	11kg



型号 Model	M.MF.K0005
电压 Voltage	220V 50Hz/110V 60Hz
功率 Power	100W
手动工作速度 Handpiece working speed	0-5000 rpm
压力调节范围 Range of pressure regulation	0-60 PSI
尺寸 Size	270×140×225mm
重量 Weight	7kg



型号 Model	M.MF.K0006
电压 Voltlage	220V 50Hz/110V 60Hz
功率 Power	150W
手动工作速度 Handpiece working speed	400-900 rpm
金刚石砂轮粒度 Diamond wheel grit	240, 600, 1200 Grit
双角度 Angle dual	90°, 105°, 120°, Any Angle Dual
尺寸 Size	290×152×187mm
重量 Weight	12.3kg



高速雕刻机  
High-speed graving machine

型号 Model	M.MF.AG001
电压 Voltlage	220V 50Hz/110V 60Hz
手动工作速度 Handpiece working speed	0-12000 RPM
压力调节范围 Range of pressure regulation	0-1 MAP
尺寸 Size	190×150×90mm
重量 Weight	2.2kg



型号 Model	M.MF.AT001
电压 Voltlage	100-240V
功率 Power	100W
速度 Speed	0-100%
尺寸 Size	220×120×180mm
重量 Weight	4.6kg



型号 Model	M.MF.AT002
电压 Voltlage	100-240V
功率 Power	160W
雕刻速度 Graver Speed	0-100%
微电机转速 Micromotor speed	0-35000RPM
尺寸 Size	220×120×180mm
重量 Weight	5kg



型号 Model	M.MF.AT003
电压 Votlage	100-240V
功率 Power	160W
雕刻速度 Graver Speed	0-100%
微电机转速 Micromotor speed	0-35000RPM
尺寸 Size	220×153×180mm
重量 Weight	6kg



型号 Model	M.MF.HR001
电压 Votlage	100-240V
功率 Power	100W
功率 Power	800W
手柄工作速度 Handpiece Working Speed	0-100%
手柄工作功率 Handpiece Working Power	0-100%
微电机转速 Micromotor speed	0-35000RPM
热风枪温度 Hot Gun Temperature	300T
尺寸 Size	210×165×120mm
重量 Weight	5kg



型号 Model	M.MF.HR002
电压 Votlage	100-240V
功率 Power	100W
雕刻速度 Graver Speed	0-100%
尺寸 Size	280×145×190mm
重量 Weight	6.5kg



## 线眼 Line hole

型号 Model: T.WM.XY001

Φ0.3mm	Φ0.65mm	Φ1.1mm	Φ1.9mm
Φ0.4mm	Φ0.70mm	Φ1.2mm	Φ1.05mm
Φ0.45mm	Φ0.75mm	Φ1.3mm	Φ2.0mm
Φ0.5mm	Φ0.80mm	Φ1.4mm	Φ2.1mm
Φ0.525mm	Φ0.85mm	Φ1.5mm	Φ2.2mm
Φ0.55mm	Φ0.9mm	Φ1.6mm	Φ0.225mm
Φ0.575mm	Φ0.95mm	Φ1.7mm	Φ0.275mm
Φ0.6mm	Φ1.0mm	Φ1.8mm	Φ3.0mm



手摇压片机 (压片压线)  
Manual rolling mill (sheet and wire)



齿轮比例 Gear ratio: 4:1  
 滚轴宽度 Roller width: 110mm  
 滚轴直径 Roller Diameter: 55mm  
 最大开度 Maximum opening: 4mm  
 平面面积 Flat area: 53mm  
 方线 Square wire(+/-0.01mm): 1.0, 2.0, 2.5, 3.0, 4.0, 4.5, 5.0  
 环柄-半圆 Ring shank-half round ellipsis :2.5×1, 3×1.25, 4×1.5mm  
 外形尺寸 Outline size: 230×135×280mm  
 包装尺寸 Package size: 330×330×230mm  
 机器毛重 G.W. : 18.5kg



齿轮比例 Gear ratio: 4:1  
 滚轴宽度 Roller width: 130mm  
 滚轴直径 Roller Diameter: 65mm  
 最大开度 Maximum opening: 4.5mm  
 平面面积 Flat area: 55mm  
 方线 Square wire(+/-0.01mm): 1.0, 2.0, 3.0, 4.0, 4.5, 5.0, 5.5, 6.0 6.5  
 环柄-半圆 Ring shank-half round ellipsis :2.5×1, 3×1.25, 4×1.5mm  
 外形尺寸 Outline size: 300×125×295mm  
 包装尺寸 Package size: 340×335×200mm  
 机器毛重 G.W. : 23kg



M.RO.00006-D

齿轮比例 Gear ratio: 4:1  
 滚轴宽度 Roller width: 130mm  
 滚轴直径 Roller Diameter: 65mm  
 最大开度 Maximum opening: 4.5mm  
 平面面积 Flat area: 63mm  
 方线 Square wire(+/-0.01mm): 1.0, 2.0, 3.0, 4.0, 4.5, 5.0, 5.5, 6.0 6.5  
 环柄-半圆 Ring shank-half round ellipsis :2.5×1, 3×1.25, 4×1.5mm  
 外形尺寸 Outline size: 300×135×295mm  
 包装尺寸 Package size: 340×335×200mm  
 机器毛重 G.W. : 24.2kg



M.RO.00008

齿轮比例 Gear ratio: 4:1  
 滚轴宽度 Roller width: 130mm  
 滚轴直径 Roller Diameter: 65mm  
 最大开度 Maximum opening: 5mm  
 平面面积 Flat area: 63mm  
 方线 Square wire(+/-0.01mm): 1.0, 2.0, 3.0, 4.0, 4.5, 5.0, 5.5, 6.0 6.5  
 环柄-半圆 Ring shank-half round ellipsis :2.5×1, 3×1.25, 4×1.5mm  
 外形尺寸 Outline size: 280×200×325mm  
 包装尺寸 Package size: 370×340×240mm  
 机器毛重 G.W. : 26.2kg



M.RO.00009

齿轮比例 Gear ratio: 4:1  
 滚轴宽度 Roller width: 110mm  
 滚轴直径 Roller Diameter: 55mm  
 最大开度 Maximum opening: 5mm  
 平面面积 Flat area: 53mm  
 方线 Square wire(+/-0.01mm): 1.0, 2.0, 3.0, 4.0, 4.5, 5.0  
 环柄-半圆 Ring shank-half round ellipsis :2.5×1, 3×1.25, 4×1.5mm  
 外形尺寸 Outline size: 260×190×310mm  
 包装尺寸 Package size: 350×330×230mm  
 机器毛重 G.W. : 24.5kg

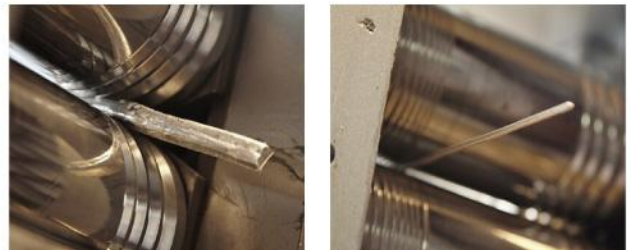



M.RO.00010

齿轮比例 Gear ratio: 4:1  
 滚轴宽度 Roller width: 90mm  
 滚轴直径 Roller Diameter: 45mm  
 最大开度 Maximum opening: 4mm  
 平面面积 Flat area: 40mm  
 方线 Square wire(+/-0.01mm): 1.0, 2.0, 3.0, 4.0, 5.0  
 环柄-半圆 Ring shank-half round ellipsis :2.5×1, 3×1.25, 4×1.5mm  
 外形尺寸 Outline size: 215×130×265mm  
 包装尺寸 Package size: 330×330×200mm  
 机器毛重 G.W. : 16kg



M.RO.00007

齿轮比例 Gear ratio: 5.3:1  
 滚轴宽度 Roller width: 100mm  
 滚轴直径 Roller Diameter: 50mm  
 最大开度 Maximum opening: 10mm  
 平面面积 Flat area: 65mm  
 方线 Square wire(+/-0.01mm): 1.0, ..... , 5.0  
 环柄-半圆 Ring shank-half round ellipsis: 5.3×1.2.....2.0×0.8mm  
 外形尺寸 Outline size: 250×135×280mm  
 包装尺寸 Package size: 360×340×200mm  
 机器毛重 G.W. : 23.6kg

手摇压片机 (镜面压片)  
 Manual rolling mill (mirror surface)

齿轮比例 Gear ratio: 4:1  
 滚轴宽度 Roller width: 110mm  
 滚轴直径 Roller Diameter: 55mm  
 最大开度 Maximum opening: 4mm  
 平面面积 Flat area: 110mm  
 外形尺寸 Outline size: 230×135×280mm  
 包装尺寸 Package size: 330×330×200mm  
 机器毛重 G.W. : 18.5kg



M.RO.00004



M.RO.00004-A

齿轮比例 Gear ratio: 4:1  
 滚轴宽度 Roller width: 130mm  
 滚轴直径 Roller Diameter: 65mm  
 最大开度 Maximum opening: 4.5mm  
 平面面积 Flat area: 130mm  
 外形尺寸 Outline size: 300×125×295mm  
 包装尺寸 Package size: 340×335×200mm  
 机器毛重 G.W. : 23kg



M.RO.00006



M.RO.00006-A

**手摇压线机 (圆线)**  
Manual rolling mill (Round wire)

齿轮比例 Gear ratio: 4:1  
 滚轴宽度 Roller width: 130mm  
 滚轴直径 Roller Diameter: 65mm  
 最大开度 Maximum opening: 5mm  
 圆线 Round wire(+/-0.01mm):  
 1.0, 1.2, 1.4, 1.8, 2.0, 2.2, 2.4, 2.6, 2.8, 3.0, 3.5, 4.0, 4.5, 5.0, 6.0, 7.0, 8.0, 9.0  
 外形尺寸 Outline size: 300×135×295mm  
 包装尺寸 Package size: 340×335×200mm  
 机器毛重 G.W.: 23kg



M.RO.00006-E

**手摇压线机 (方线)**  
Manual rolling mill (Square wire)

齿轮比例 Gear ratio: 4:1  
 滚轴宽度 Roller width: 130mm  
 滚轴直径 Roller Diameter: 65mm  
 最大开度 Maximum opening: 5mm  
 方线 Square wire(+/-0.01mm): 1.0, 2.0, 3.0, 4.0, 4.5, 5.0, 5.5, 6.0, 6.5.....8.0  
 外形尺寸 Outline size: 300×135×295mm  
 包装尺寸 Package size: 340×335×200mm  
 机器毛重 G.W.: 23kg



M.RO.00006-B

M.RO.00006-C

**单头电动压片机**  
Single head electric rolling mill

型号 Model: M.RO.00015  
 电源 Power: 2HP  
 电压 Voltage: 110V / 220V  
 滚轮宽度 Roller width: 130mm  
 滚轮直径 Roller Diameter: 65mm  
 最大开口 Maximum Opening: 5mm  
 平面面积 Flat Area: 63mm  
 方线 (+/-0.01mm): 1.0, 2.0, 3.0, 4.0, 4.5, 5.0, 5.5, 6.0, 6.5  
 环柄-半圆 Ring shank-half round ellipsis: 2.5×1mm, 3×1.25mm, 4×1.5mm  
 尺寸 Dimension: 450×250×510mm  
 包装尺寸 Shipping Dimension: 600×410×660mm  
 包装重量 Shipping Weight: 72.5kg



**双头电动压片机**  
Single head electric rolling mill

型号 Model: M.RO.00016  
 电源 Power: 2HP  
 电压 Voltage: 110V / 220V  
 滚轮宽度 Roller width: 130mm  
 滚轮直径 Roller Diameter: 65mm  
 最大开口 Maximum Opening: 5mm  
 平面面积 Flat Area: 130mm  
 方线 (+/-0.01mm): 1.0, 1.25, 1.5, 1.75, 2.0, 2.25, 2.5, 2.75, 3.0, 3.25, 3.5, 3.75,  
 4.0, 4.25, 4.5, 5.0, 5.5, 6.0, 7.0, 8.0  
 尺寸 Dimension: 660×260×510mm  
 包装尺寸 Shipping Dimension: 810×460×670mm  
 包装重量 Shipping Weight: 108kg



型号 Model: M.RO.00030  
 滚轴直径 Roller diameter: 70mm  
 滚轴长度 Roller length: 250mm  
 尺寸 Size: 400×300×120mm  
 重量 Weight: 43kg

半圆 Semi-Round: 3/1 2/3/4/5/6/7/8/9/10/11/12/13/14mm  
 双面泥鳅背半圆 Double-Sided Loach-Back Semi-Round: 上3/1 下6/12/3/4/5/6/7/8/9/10/11/12/13mm



型号 Model: M.RO.00031  
 滚轴直径 Roller diameter: 70mm  
 滚轴长度 Roller length: 250mm  
 尺寸 Size: 400×300×120mm  
 重量 Weight: 43kg

羊面轮胎型 Sheep-Face Tire Profile  
 宽度 Width: 3/4/5/6/7/8/9/10/11/12/13/14/15/16/17/18/19/20mm  
 厚度 Tableting Surface Thickness: 1.2/1.4/1.6/2.6/2.8/3.2/3.2/3.5/3.5/3.8/3.8/3.8/3.8/3.8/3.8/4/4mm

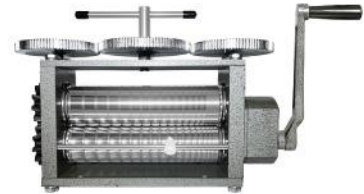

型号 Model: M.RO.00032  
 滚轴直径 Roller diameter: 70mm  
 滚轴长度 Roller length: 250mm  
 尺寸 Size: 400×300×120mm  
 重量 Weight: 43kg

压方(有倒角) Square with Chamfer: 1.5/2/2.5/3/4/5/6/7/8/9/10/11/12mm  
 压片 Tableting Surface: 54mm  
 椭圆泥鳅背 Oval Loach-Back: 4/5/6/7/8/9/10/11/12mm 上面厚度宽度的1/6, 下面宽度的1/3  
 Upper Width: 1/6, Lower Width: 1/3

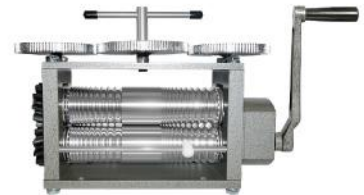

型号 Model: M.RO.00033  
 滚轴直径 Roller diameter: 70mm  
 滚轴长度 Roller length: 250mm  
 尺寸 Size: 400×300×120mm  
 重量 Weight: 43kg

椭圆泥鳅背 Oval Loach-Back: 4/5/6/7/8/9/10/11mm 上面宽度的1/6,下面宽度的1/3  
 Upper Width: 1/6, Lower Width: 1/3  
 半圆 Semi-Round 1/4: 4.0/5.0/6.0/7.0/8.0/9.0/10/11mm  
 压圆 Round Concave: 2.5/2.7/2.9/3.1/3.3/3.6/3.8/4.0/4.3/4.5/4.8/5.0/5.5/6.0/6.5/7.0/8.0mm



型号 Model: M.RO.00034  
 滚轴直径 Roller diameter: 70mm  
 滚轴长度 Roller length: 250mm  
 尺寸 Size: 400×300×120mm  
 重量 Weight: 43kg

压圆 Round Concave: 2.52/2.75/3/3.25/3.5/3.75/4/4.25/4.5/5/5.5/6/6.5/7/7.5/8mm  
 半圆 Semi-Round 1/3: 7/8/9/10/11/12mm  
 压方 Square: 4/5/6/7/8mm 压片 Tableting Surface: 45mm

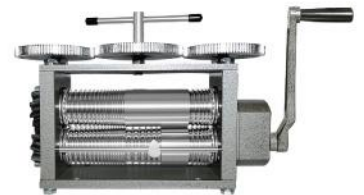

型号 Model: M.RO.00035  
 滚轴直径 Roller diameter: 70mm  
 滚轴长度 Roller length: 250mm  
 尺寸 Size: 400×300×120mm  
 重量 Weight: 43kg

压圆 Round Concave: 2/2.1/2.2/2.3/2.4/2.5/2.6/2.7/2.8/2.9/3/3.1/3.2/3.3/3.4/3.5 /3.6/3.7/3.8/3.9/4/4.2  
 4.4/4.6/4.8/5/5.2/5.4/5.6/5.8/6/6.2/6.5/6.8/7.2/7.6/8/9/10mm



型号 Model: M.RO.00036  
 滚轴直径 Roller diameter: 70mm  
 滚轴长度 Roller length: 250mm  
 尺寸 Size: 400×300×120mm  
 重量 Weight: 43kg

全圆 Full Round: 1/1.1/1.2/1.3/1.4/1.5/1.6/1.7/1.8/1.9/2/2.1/2.2/2.3/2.4/2.5/2.6/2.83/3.2/3.4/3.6/3.8/4  
 4.2/4.5/4.7/5/5.3/5.6/6/6.3/6.8/7/7.5/8/8.5/9/10/11/12/13mm



型号 Model: M.RO.00037  
 滚轴直径 Roller diameter: 70mm  
 滚轴长度 Roller length: 250mm  
 尺寸 Size: 400×300×120mm  
 重量 Weight: 38.5kg

椭圆泥鳅背 Oval Loach-Back: 5/6/7/8/9/10/12 上面厚度宽度的1/6, 下面厚度宽度的1/3  
 Upper Width: 1/6, Lower Width: 1/3  
 半圆: 3/4/5/6/7/8/9/10/11/12 厚度是宽度的1/3  
 薄椭圆: 3/4/5/6/7/8/9/10/11/12 单边厚度是宽度的1/6



型号 Model: M.RO.00038

滚轴直径 Roller diameter: 70mm

滚轴长度 Roller length: 250mm

尺寸 Size: 400×300×120mm

重量 Weight: 43kg

压圆 Round Concave: 2.5/2.7/2.9/3.1/3.3/3.6/3.8/4/4.3/4.5/4.8/5/5.5/6/6.5/7/8mm

半圆 Semi-Round: 4/5/6/7/8/10mm 槽深直径1/4 Groove Depth: 1/4 of Diameter

压方 (有倒角) Square with Chamfer: 4/5/6/7/8mm 压片 Tableting Surface: 50mm



型号 Model: M.RO.00039

滚轴直径 Roller diameter: 55mm

滚轴长度 Roller length: 122mm

重量 Weight: 18.5kg

压圆 Round Concave: 2/3/4/5/6/7mm

压方 (有倒角) Square with Chamfer: 2/3/4/5/6/7mm

压片 Tableting Surface: 40mm



戒指内孔刻字机

Inside ring engraver



M.RE.K0001  
250×195×420mm 6.5kg

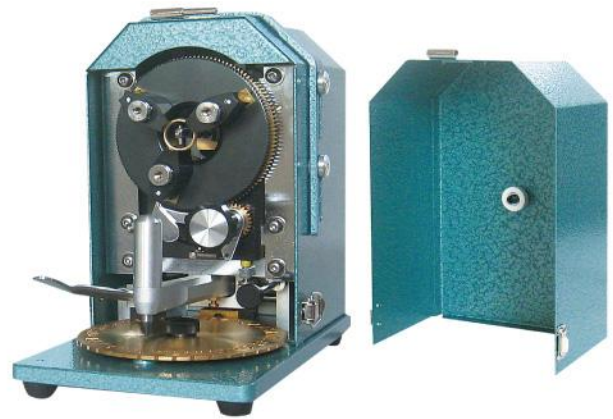

M.RE.K0002  
250×200×270mm 5.6kg

用途: 可刻英文和字母

Application: chinese and english engraving

雕刻字体: 最高2mm, 最矮1.5mm

Carving font: Maximum 2mm, Minimum 1.5mm



正面 Front



背面 Back

拉线板  
Drawingplates

NO.1-9 优质钨钢 Good-quality tungsten steel | NO.10-28 普通材质 Normal materials

编号 NO.	名称 Description	代码 Model	线孔直径 (mm) Round hole diameter	备注 Remark
1	圆形拉线板 (鹰牌) Round drawplates	T.WM.A0023	● 0.26-2.2	3排/Rows 36孔/Holes
2	圆形拉线板 (鹰牌) Round drawplates	T.WM.A0024	● 2.3-6.0	2排/Rows 24孔/Holes
3	圆形拉线板 (鹰牌) Round drawplates	T.WM.A0028	● 6.1-8.0	2排/Rows 20孔/Holes
4	圆形拉线板 (鹰牌) Round drawplates	T.WM.A0042	● 8.1-10.0	2排/Rows 20孔/Holes
5	圆形拉线板 (鹰牌) Round drawplates	T.WM.A0027	● 3.1-7.1	2排/Rows 20孔/Holes
6	圆形拉线板 (鹰牌) Round drawplates	T.WM.A0025	● 6.25-10	2排/Rows 16孔/Holes
7	圆形拉线板 (鹰牌) Round drawplates	T.WM.A0036	● 10.15-13	2排/Rows 20孔/Holes
8	圆形拉线板 (鹰牌) Round drawplates	T.WM.A0039	● 12-14.00	2排/Rows 16孔/Holes
9	圆形拉线板 Round drawplates	T.WM.A0032	● 0.26-2.8	3排/Rows 42孔/Holes
10	长方形拉线板 Square drawplates	T.WM.A0021-2	■ 0.55-3.0	3排/Rows 30孔/Holes
11	长方形拉线板 Square drawplates	T.WM.A0021	■ 3.1-5.0	2排/Rows 20孔/Holes
12	四方形拉线板 Quadrilateral drawplates	T.WM.A0012	■ 0.55-3.0	3排/Rows 30孔/Holes
13	四方形拉线板 Quadrilateral drawplates	T.WM.A0016	■ 3.1-5.0	2排/Rows 20孔/Holes
14	四方形拉线板 Quadrilateral drawplates	T.WM.A0018	■ 5.1-7.0	2排/Rows 20孔/Holes
15	六角形拉线板 Hexagon drawplates	T.WM.A6001	⬡ 0.55-3.0	3排/Rows 30孔/Holes
16	六角形拉线板 Hexagon drawplates	T.WM.A6002	⬡ 3.1-5.0	2排/Rows 20孔/Holes
17	六角形拉线板 Hexagon drawplates	T.WM.A6003	⬡ 5.1-7.0	2排/Rows 20孔/Holes
18	六角形拉线板 Hexagon drawplates	T.WM.A6004	⬡ 7.1-9.0	2排/Rows 20孔/Holes
19	半圆拉线板 Semicircular drawplates	T.WM.B6001	◐ 0.55-3.0	3排/Rows 30孔/Holes
20	半圆拉线板 Semicircular drawplates	T.WM.B6002	◐ 3.1-5.0	2排/Rows 20孔/Holes
21	半圆拉线板 Semicircular drawplates	T.WM.B6003	◐ 5.1-7.0	2排/Rows 20孔/Holes
22	半圆拉线板 Semicircular drawplates	T.WM.B6004	◐ 7.1-9.0	2排/Rows 20孔/Holes
23	马眼拉线板 Marquise drawplates	T.WM.B6005	◌ 3.1-5.0	2排/Rows 20孔/Holes
24	蛋形拉线板 Oval drawplates	T.WM.B6006	◉ 3.1-5.0	2排/Rows 20孔/Holes
25	月亮形 (空心半圆) Moon drawplates	T.WM.B6007	☾ 1.1-3.0	2排/Rows 20孔/Holes
26	月亮形 (空心半圆) Moon drawplates	T.WM.B6008	☾ 3.1-5.0	2排/Rows 20孔/Holes
27	三角形拉线板 Triangular drawplates	T.WM.A0034	▲ 0.55-3.0	2排/Rows 20孔/Holes
28	三角形拉线板 Triangular drawplates	T.WM.A0035	▲ 3.1-5.0	2排/Rows 20孔/Holes



### 钻石腰码仪-3代 Diamond girdle viewer III

型号 Model: T.JD.00001

包装尺寸 Product size: 480×435×375mm

第三代钻石GIA腰码显微镜提供一种创新的解决方案来快速高效的查看裸钻和成品钻石饰品的编号，包括证书号码、品牌标识等。

The digital girdle viewer is an innovative solution to display the wide variety of information on a digital screen from a diamond's girdle, including certificate numbers, brand logos, security marks, etc.

- 全金属机身设计
- 独特的内置锂电池：可连续工作6小时
- 高精度摄像头：放大倍率 30X到110X
- 超高清显示器：4.3寸LCD显示器
- 配套裸钻和成品平台，适用于不同的工作场景
- 全球化电压设计：100-240V
- 观察石头大小：0.20克拉-12克拉
- Full metal body
- Built-in lithium battery: can work continuously for 6 hours
- High precision camera: Magnification 30X to 110X
- HD display: 4.3 inch LCD Screen
- Special holders for both rings and loose diamond
- Voltage: 100-240V
- Reading Range: 0.20ct-12ct



### 宝石偏光镜-白黄双色温 Gemstone polariscope-dual light

T.JD.00002

电压 Voltage: 110V-220V

第三代钻石GIA腰码显微镜提供一种创新的解决方案来快速高效的查看裸钻和成品钻石饰品的编号，包括证书号码、品牌标识等。

The Digital Girdle Viewer is an innovative solution to display the wide variety of information on a digital screen from a diamond's girdle, including certificate numbers, brand Logos, security marks, etc.

#### 双光源切换

黄光具有良好的穿透力，可以揭示玉石内部的裂纹和杂质，而白光则具有出色的色彩还原能力，能展现宝石的真实颜色。

#### Dual Light Source Switching

Yellow light penetrates well, revealing internal cracks and impurities in jade, while white light offers excellent color rendering, showcasing the gemstone's true color.

#### 一般信息

宝石偏光镜是一种常用的宝石测试工具。它通过检测光的旋转和双折射，帮助确定宝石的特性和真实性。它用于区分均匀和非均匀宝石，识别晶体（微晶或隐晶）聚集体，并评估异常双折射。此外，它还可以确定宝石的轴向并检查其多色性。借助干涉镜，可以观察干涉图案以进行进一步分析。

#### General Information

A gemstone polariscope is a common tool for testing gemstones. It detects light rotation and birefringence, helping determine a gemstone's properties and authenticity. It's used to distinguish between homogeneous and non-homogeneous gemstones, identify crystalline aggregates, and assess abnormal birefringence. Additionally, it can determine the axiality of gemstones and check for pleochroism. With a conoscopic lens, the interference pattern can be observed for further analysis.



## 多功能钻石观测仪 -2 代 Muti Diamond Viewer II

T.JD.00001

多功能钻石观测仪是一款专为同时观察钻石腰部编码码钻石火彩而设计的设备。该设备配备高清摄像头和10.1英寸显示屏，提供清晰的视觉效果，突出钻石的精细细节。

多功能钻石观测仪的突出特点之一是其可调节的光源系统。这允许用户能快速而真实的还原钻石的火彩，包括钻石心与箭的图案。该设备展示钻石自然特性的能力使其成为专业人士的必备工具。

除了强大的性能外，多功能钻石观测仪还注重便携性。它配备内置锂电池，确保设备易于运输并在各种环境中使用，无论是零售环境、贸易展还是营销活动。这种多功能性使其成为钻石零售商和营销人员的理想选择，他们需要可靠且移动的解决方案来展示钻石。

通过提供钻石特性的深入和即时的视觉表示，增强了客户体验，使他们能够快速直观地欣赏钻石的各种特征。

Multi diamond viewer ii is specifically designed to allow the simultaneous viewing of a diamond's laser inscription on its girdle and its brilliance. The device is equipped with a high-definition camera and a 10.1-inch display, delivering crystal-clear visuals that highlight the intricate details of the diamond.

One of the standout features of multi diamond viewer ii is its adjustable lighting system. This allows users to manipulate the light settings to observe the diamond under various conditions, revealing its true brilliance, including the diamond heart & arrow pattern. The device's ability to showcase the diamond's natural qualities makes it an indispensable tool for professionals who need to present diamonds in the best possible light.

In addition to its powerful performance, multi diamond viewer ii is designed with portability in mind. It comes with a built-in lithium battery, ensuring that the device can be easily transported and used in various settings, whether in a retail environment, at trade shows, or during marketing events. This versatility makes it ideal for diamond retailers and marketers who require a reliable and mobile solution for displaying diamonds.

By providing an in-depth and immediate visual representation of a diamond's features, multi diamond viewer ii enhances the customer experience, allowing them to appreciate the full range of a diamond's characteristics quickly and intuitively.



## 紫外荧光灯箱 Gemstone UV light box set



抽屉式款  
Drawer-style storage

型号 Model: T.JD.00004-1



开放式款  
Drawerless open storage compartment

型号 Model: T.JD.00004-2



便携式款  
Portable version

型号 Model: T.JD.00004-3

紫外荧光灯在珠宝检测中，是一种重要的辅助性仪器。使用长波和短波两种紫外灯管，利用特制的滤光片过滤后获得以365nm 为主波长的长波 (LW) 紫外光和以 253.7nm 为主波长的短波 (SW) 紫外光，并将这两种不同的紫外光分别照射于宝石上，使之产生不同程度的荧光反应，以此来鉴定宝石。

Ultraviolet (UV) fluorescent lamps are essential auxiliary tools in gem identification. By using both long-wave and short-wave UV tubes and specialized filters, we can obtain long-wave (LW) UV light with a dominant wavelength of 365nm and short-wave (SW) UV light with a dominant wavelength of 253.7nm. When these two different types of UV light are directed at gemstones, they induce varying degrees of fluorescence, which can be used to identify the gems.

## 钻石火彩仪 New rotation diamond brilliance viewer

型号 Model: T.JD.00005-1

电压 Voltage: 100-220V

- 一个方便使用的设备来 - 查看钻石的火彩。
- 聚光效果好，观测效果好。
- 可旋转的托盘可以容纳戒指和钻石。

- One easy-to-use equipment to view diamond brilliance.
- Fine light gathering and excellent observation effect.
- Rotatable pallet can hold both ring and diamond stone.



### 钻石火彩仪 2代 Diamond Brilliance Viewer II

该设备旨在提升钻石火彩的显示，确保为您的客户带来难忘的经验。它具有人性化的控制功能，包括转盘速度和灯光调节、安全锁定机制，以及高清LCD屏幕，所有这些都融入在金属一体化设计中。支持100-240V的电压范围，适用于各种场合。

A revolutionary tool for showcasing the stunning beauty of diamonds. This device is designed to enhance the brilliance of your diamonds, ensuring an unforgettable experience for your customers. It features user-friendly controls for turntable speed and lighting, a secure locking mechanism, and a high-definition LCD screen—all housed in a durable integrated metal body. Compatible with a voltage range of 100-240V, it's perfect for any setting.

型号 Model: T.JD.00005-2  
 屏幕尺寸 Screen size: 7.9"  
 电压 Voltage: 110V-220V  
 包装尺寸 Package size: 430×280×230mm  
 产品重量 Product weight: 7kg



### 天然钻石群测仪 Natural diamond scanner

型号 Model: T.JD.00006

天然钻石群测仪是一款先进的设备，旨在准确识别和区分天然钻石与实验室培育钻石。它利用尖端技术分析钻石的各种特征，实时提供数据，帮助用户做出明智的决策。该设备体积小且易于操作，非常适合珠宝商、宝石学家和爱好者，确保在任何环境下都能验证钻石的真实性。凭借其精确的测量和快速的结果，天然钻石群测仪是提升钻石评估信心的最佳工具。

The natural diamond scanner is an advanced device designed for accurately identifying and distinguishing natural diamonds from lab-grown counterparts. Utilizing cutting-edge technology, it analyzes various characteristics of the diamond, providing users with real-time data to make informed decisions. Compact and user-friendly, this scanner is ideal for jewelers, gemologists, and enthusiasts alike, ensuring the authenticity of diamonds in any setting. With its precise measurements and quick results, the natural diamond scanner represents the ultimate tool for enhancing confidence in diamond evaluations.



### 专业级宝石显微镜 Motic-171 含智能系统屏 PROFESSIONAL GEM MICROSCOPE+MOTIC SMZ-171 WITH SCREEN

型号 Model: T.JD.00008

放大倍率: 7.5-50X (连续变焦)	Magnification: 7.5-50X
目镜: WF10X	Eyepiece: WF10X
20W 暗视域	Bright field, dark field (Halogen 20W)
W 前侧灯照明, LED 点光源	7W front illuminator
显微镜镜头: Motic	LED point source
暗视域光圈: 2 毫米 -41 毫米	Iris diaphragm: 2mm-41mm
工作距离: 110mm	Working distance: 110mm
弯臂: 38°倾斜	Inclinable up to 38 degrees for better comfort and view
底座: 0° -325°可旋转	Base: 0°-325°rotatable
电压: 100V-240V	Voltage: 100-240V
包装尺寸: 680×360×400mm	Product size: 680×360×400mm
重量: 12kg	Weight: 12kg



### 宝石测试仪-2代 Gem Tester II

型号 Model: T.JD.00008-1  
 包装尺寸 Product size: 195×110×95mm  
 重量 Weight: 0.7kg

业内最薄的探头 (0.6mm)，用于测试小至0.02克拉的宝石  
 可以区分16种宝石  
 内置校准模组，可快速校准仪器

Industry's thinnest probe tip (0.6mm) for testing gemstones as small as 0.02 carats  
 Can differentiate between 16 types of gemstone  
 Built-in Glass and Calibration (CAL) test discs for reference



## 拉曼光谱仪 Smartphone Raman Spectrometer

全球首款基于智能手机的珠宝拉曼设备现已面向全球宝石爱好者推出。  
The world's first smartphone-based Jewelry Raman device is now available for gemstone enthusiasts worldwide.



型号 Model: T.JD.00007

1. 该设备采用成熟的拉曼技术，在宝石检测领域树立了全新的精度和可靠性标准，超越了紫外荧光机、钻石测试笔以及其他所有传统的手动检测工具。
  2. 灵活的光纤探头可用于检测裸石和镶嵌石，此外，它还能对小至 0.01 克拉的宝石进行选择性地检测，测量过程只需几秒钟即可完成。
  3. 与智能手机平台的集成提供了用户友好的图形界面，使得捕捉照片和光谱变得极为简单快速。报告的保存与分享只需三次快速点击即可完成。
1. Utilizing the proven Raman ID technique, it sets a new standard for precision and reliability in gemstone inspections, surpassing UV fluorescence machines, diamond test pens, and all other conventional manual inspection tools.
2. The flexible fiber probe allows testing of both loose and mounted stones. Additionally, it can pinpoint stones down to 0.01 carats for selective measurements in a matter of seconds.
3. The integration with the smartphone platform provides a user-friendly graphic interface, making it incredibly easy and fast to capture photos and spectra. Report saving and sharing can be accomplished with just three swift clicks.

## 宝石双重测试仪 Duo tester

型号 Model: T.JD.00008-2  
包装尺寸 Product size: 195×110×95mm  
重量 Weight: 0.7kg

提供双重测试方法：热导性和反射率来鉴定有色宝石以及钻石。测试笔利用宝石传热速度的不同，来识别彩色宝石和钻石。中间测试平台利用反射率测试彩色宝石和钻石。

The only gemological instrument in the industry that tests gemstones based on both thermal and reflectivity properties. Provides the user with two proven tests for diamonds and differentiate similar colored gemstones.



## 数字折射仪 Refractive Index Meter

型号 Model: T.JD.00009  
包装尺寸 Product size: 135×78×45mm  
重量 Weight: 0.25kg

- 数字折射仪可测试钻石、莫桑石、彩色宝石
- 折射率1.000RI-3.000RI
  - 快速可靠的测试结果
  - 显示屏直接显示测试结果
  - 9V电池和一个USB接口

Reflectance tester for diamonds, moissanites and gemstones.

- Identifies diamonds, moissanites and gemstones via its
- Refractive Index (RI), 1.000 to 3.000, on flat and polished surfaces
- Reliable results
- Clear and visible display
- 9V battery and USB port



## 钻石测试笔 Diamond mate

型号 Model: T.JD.00010  
包装尺寸 Product size: 200×80×60mm  
重量 Weight: 0.15kg

通过导热性来测试钻石或锆石。  
The tester utilizes thermal conductivity testing method to verify the authenticity of diamonds, and distinguish from dozens of diamond simulants.



**莫桑石测试笔 II**  
**Moissanite Tester II**

型号 Model: T.JD.00011  
包装尺寸 Product size: 200×80×60mm  
重量 Weight: 0.15kg

通过聚合物电导率来测试钻石或者莫桑石。  
The tester uses the technology of capacitive measurement of electrical displacement to identify synthetic moissanite stones.



**多用测试笔 3代**  
**Multi Tester III**

型号 Model: T.JD.00012  
包装尺寸 Product size: 200×80×60mm  
重量 Weight: 0.25kg

最畅销的钻石&莫桑石测试笔，探针尖端可伸缩，确保在测试期间对宝石的压力一致，从而获得最可靠的测试结果，可测小至0.02克拉的无色钻石。

The best-selling pocket-sized instrument that instantly identifies diamonds and moissanites based on their thermal and electrical properties. PMuT III has a retractable probe tip that ensures consistent pressure against the gemstone during testing for more reliable results. tests colorless diamonds as small as 0.02ct.



**合成钻石鉴别仪-II代**  
**Synthetic diamond screener II**

型号 Model: T.JD.00013-1  
包装尺寸 Product size: 195×110×95mm  
重量 Weight: 0.8kg

- 增强了额外的功能，可测试小至0.02克拉到10克拉测试结果瞬间完成，通过测量紫外线吸收。
- 快速测试采用高温高压处理的HPHT或化学气相沉积法合成钻石（CVD）。支持裸石以及成品裸石饰品样本的测试。
- 可筛选钻石颜色范围：D到J

- Enhanced with additional features, the synthetic DiamondScreenerII now tests for diamond melee as small as 0.02carats with instantaneous results, through the measurement of UV absorption.
- The Synthetic Diamond Screener II is developed by Presidium to help screen out Type IIa colorless diamond, which is likely to be synthetic and created through chemical vapor deposition (CVD) or high pressure high temperature (HPHT) synthesis from the natural Type Ia colorless diamond.
- For diamond color: D to J



**新款合成钻石测试笔**  
**OTI BY PRESIDIUM**

型号 Model: T.JD.00013-2



**合成钻石测试笔**  
**ARI BY PRESIDIUM**

型号 Model: T.JD.00013-3





**钻石工具套装  
Diamond Tools Set**

型号 Model: T.JD.00020  
包装尺寸 Product size: 320×250×70mm  
重量 Weight: 2kg

- |            |                            |
|------------|----------------------------|
| 1. 比色石     | 1. Master Color Set        |
| 2. 比重石     | 2. Master Size Set         |
| 3. 钻石净度表   | 3. Diamond Clarity Display |
| 4. 钻石切工板表  | 4. Diamond Cut Display     |
| 5. 戒指圈     | 5. Ring Sizer              |
| 6. 戒指棒     | 6. Ring Stick              |
| 7. 镊子      | 7. Tweezer                 |
| 8. 10 倍放大镜 | 8. Triplet 10X Loupe       |
| 9. 切工镜     | 9. Heart and Arrow Scope   |
| 10. 腰围镜    | 10. Inscription Loupe      |
| 11. 长宝石爪   | 11. Stone Holder           |
| 12. 戒托     | 12. Ring Holder            |
| 13. 荧光笔    | 13. UV Troch               |
| 14. 测钻笔    | 14. Diamond Tester         |



**钻石工具套装  
Diamond Tools Set**

型号 Model: T.JD.00021  
包装尺寸 Product size: 330×260×50mm  
重量 Weight: 1.2kg

- |           |                          |
|-----------|--------------------------|
| 1. 测钻笔    | 1. Diamond Tester        |
| 2. 腰围镜    | 2. Inscription Loupe     |
| 3. 切工镜    | 3. Heart and Arrow Scope |
| 4. 钻石卡尺   | 4. Digital Gauge         |
| 5. 放大镜    | 5. Loupe                 |
| 6. 宝石爪    | 6. Stone Holder          |
| 7. 手电     | 7. Torch                 |
| 8. 戒爪     | 8. Ring Holder           |
| 9. 镊子     | 9. Tweezer               |
| 10. 钻石火彩笔 | 10. Inscription Loupe    |
| 11. 手寸棒   | 11. Ring Stick           |
| 12. 手寸圈   | 12. Ring Sizer           |



**钻石工具套装  
Diamond Tools Set**

型号 Model: T.JD.00022  
包装尺寸 Product size: 250×220×150mm  
重量 Weight: 2kg

- |           |                                |
|-----------|--------------------------------|
| 1. 测钻笔    | 1. Diamond Tester              |
| 2. 腰围镜    | 2. Inscription Loupe           |
| 3. 豪华型切工镜 | 3. Delux Heart and Arrow Scope |
| 4. 放大镜    | 4. Loupe                       |
| 5. 手电     | 5. Torch                       |
| 6. 镊子     | 6. Tweezer                     |
| 7. 手寸棒    | 7. Ring Stick                  |
| 8. 手寸圈    | 8. Ring Sizer                  |



**钻石仪器套装箱  
Diamond Tools with Aluminum Box**

型号 Model: T.JD.00023  
包装尺寸 Product size: 220×190×70mm  
重量 Weight: 1kg

- |           |                        |
|-----------|------------------------|
| 1. 切工镜    | 1. Heart & Arrow Loupe |
| 2. 放大镜    | 2. Loupe               |
| 3. 钻石铲    | 3. Scoop               |
| 4. 腰围镜    | 4. Inscription Loupe   |
| 5. 戒指形宝石爪 | 5. Ring Stone Holder   |
| 6. 数显卡尺   | 6. Digital Gem Gauge   |
| 7. 镊子     | 7. Tweezer             |
| 8. 双光手电   | 8. Double Light Torch  |



**宝石鉴定仪器套装箱  
Gemological Kit with Aluminum Box**

型号 Model: T.JD.00024  
包装尺寸 Product size: 220×190×70mm  
重量 Weight: 1kg

- |           |                      |
|-----------|----------------------|
| 1. 手电     | 1. LED Torch         |
| 2. 分光镜    | 2. Spectroscope      |
| 3. 二色镜    | 3. Dichroscope       |
| 4. 便携秤    | 4. Pocket Scale      |
| 5. 放大镜    | 5. Loupe             |
| 6. 镊子     | 6. Tweezer           |
| 7. 宝石数显卡尺 | 7. Digital Gem Gauge |
| 8. 滤色镜    | 8. Filter            |



**宝石鉴定仪器套装箱-专业型  
Economical Gem Identification Travel Lab**

型号 Model: T.JD.00025  
包装尺寸 Product size: 360×270×120mm  
重量 Weight: 3.5kg

- |              |                          |
|--------------|--------------------------|
| 1. 宝石折射仪     | 1. Gem Refractometer     |
| 2. 偏光镜       | 2. Portable Polaroscope  |
| 3. 镊子        | 3. Diamond Tweezer       |
| 4. 手电        | 4. LED Torch             |
| 5. 二色镜       | 5. Dichroscope           |
| 6. 分光镜       | 6. Spectroscope          |
| 7. 玉石滤色镜     | 7. Jadeite Filter        |
| 8. 硬度笔 (5-9) | 8. Mohs's Hardness (5-9) |
| 9. 放大镜       | 9. Triplet Loupe         |

数码旋转摄影箱  
360 PHOTOGRAPHY BOX



T.BS.00006



T.BS.00007



T.BS.00008

型号 Model	外观尺寸 Product size	拍摄尺寸 Shooting rang	正面开口 Front windows	包装尺寸 Package size	重量 Weight
T.BS.00006	300×240×230mm	238×200×182mm	110×155mm	445×390×385mm	7kg
T.BS.00007	350×300×280mm	288×260×220mm	130×175mm	480×435×425mm	9kg
T.BS.00008	400×360×330mm	332×315×270mm	180×195mm	525×485×470mm	12kg

数码摄影箱  
Photography Box



T.BS.00001



T.BS.00002



T.BS.00003



T.BS.00004



T.BS.00005

型号 Model	外观尺寸 Product size	拍摄尺寸 Shooting rang	正面开口 Front windows	包装尺寸 Package size	重量 Weight
T.BS.00001	260×200×200mm	196×155×145mm	100×120mm	405×345×355mm	5.5kg
T.BS.00002	300×240×230mm	238×200×182mm	110×155mm	445×390×385mm	7kg
T.BS.00003	350×300×280mm	288×260×220mm	130×175mm	480×435×425mm	9kg
T.BS.00004	400×360×330mm	332×315×270mm	180×195mm	525×485×470mm	12kg
T.BS.00005	600×500×500mm	528×430×425mm	310×550mm	760×700×660mm	39kg



木柄港度戒指尺  
HK size ring stick with wood handle  
T.RC.RR001



木柄美度戒指尺  
US size ring stick with wood handle  
T.RC.RR003



TSK木柄港度戒指尺  
TSK HK size ring stick with wood handle  
T.RC.RR046



不锈钢美度戒指尺  
US size stainless steel ring stick  
T.RC.RR004



不锈钢港度戒指尺  
HK size stainless steel ring stick  
T.RC.RR006



全铝四用戒指尺  
Aluminium universal ring measure stick  
T.RC.RR005



不锈钢港度尺  
HK size stainless steel ring stick  
T.RC.RR006-1 1#-33#



不锈钢港度尺  
HK size stainless steel ring stick  
T.RC.RR006-2 1#-34#



不锈钢港度尺  
HK size stainless steel ring stick  
T.RC.RR006-3 1#-33#



不锈钢美度尺  
HK size ring stick with wood handle  
T.RC.RR004-2 1#-15#



戒指钢尺  
Stainless steel ring stick  
T.RC.RR070



戒指钢尺  
Stainless steel ring stick  
T.RC.RR070-1



戒指铁 (大)  
lorn ring stick (big)  
T.RC.RR017  $\Phi 25 \times \Phi 12 \times 270\text{mm}$



5分戒指铁  
5" lorn ring stick  
T.RC.RR028



4分戒指铁  
4" lorn ring stick  
T.RC.RR050



特大戒指铁  
lorn ring stick  
T.RC.RR028-2  $\Phi 37 \times \Phi 19 \times 305\text{mm}$



带柄戒指铁  
Iorn ring stick  
T.RC.RR028-3  $\Phi 24 \times \Phi 12 \times 325\text{mm}$



长方形整形铁  
Rectangular shaped iron  
T.RC.RR028-4 12×7mm, 23×18mm, L180mm



四方形整形铁  
Square shaped shaping iron  
T.RC.RR028-5 7×7mm, 18×18mm, L180mm



细鹅巨铁  
Square shaped shaping iron  
T.RC.RR028-6 4×10mm, 19×20mm, L180mm



美国蜡戒指尺  
Matt wax ring stick  
T.RC.RR009



欧度绿色四面戒指尺  
Euro size ring stick  
T.RC.RR010



白塑料港度尺  
HK white plastic ring stick  
T.RC.RR070



日度网纹柄戒指铁  
Japan ring stick  
T.RC.RR078-A



铝日度尺  
Japan aluminum ring stick  
T.RC.RR072



美度网纹柄戒指铁  
US ring stick  
T.RC.RR078-B



港度网纹柄戒指铁  
HK ring stick  
T.RC.RR078-C



不锈钢戒指铁  
Stainless steel ring of iron  
T.RC.RR100  $\Phi 19.5 \times \Phi 37 \times 305\text{mm}$



特大戒指铁  
Extra large ring of iron  
T.RC.RR101  $\Phi 10.5 \times \Phi 24 \times 280\text{mm}$





特硬戒指铁  
Extra hard ring of iron  
T.RC.RR102  $\Phi 11 \times \Phi 24.5 \times 270 \text{mm}$

4分5分耳环铁  
Ring of iron  
T.RC.RR103  $\Phi 10.5 \times \Phi 24 \times 265 \text{mm}$

普通戒指铁  
Extra hard ring of iron  
T.RC.RR104  $\Phi 6.5 \times \Phi 16 \times 185 \text{mm}$



港度尺圈套装  
HK ring sizes  
T.RC.RR075-A



港度尺圈  
HK ring sizes  
T.RC.RR076



港度尺圈  
HK ring sizes  
T.RC.RR077

戒指圈  
Ring sizes

代码 Model	规格 specifications	材质 Material quality
T.RC.RR014-2	US 美度圈 0#-13#	锌合金 Kirsite
T.RC.RR013	HK 港度圈 1#-33#	不锈钢 Stainless steel
T.RC.RR013-2	HK 港度圈扁圆 1#-33#	不锈钢 Stainless steel
T.RC.RR015	JP 日度圈 1#-28#	不锈钢 Stainless steel
T.RC.RR201	KR 韩度圈 1#-30#	-
T.RC.RR202	四用圈 1#-33#	-
T.RC.RR014	US 美度圈 0#-15#	-
T.RC.RR051	EURO 欧度圈 41#-76#	-
T.RC.RR203	UK 英度圈 A-Z	-
T.RC.RR204	RU 俄罗斯度 13#-25#	不锈钢 Stainless steel
T.RC.RR205	VN 越度 1#-33#	不锈钢 Stainless steel
T.RC.RR206	TW 台度 3#-24#	不锈钢 Stainless steel



彩色塑料港度圈  
HK colored plastic ring

代码 Model	颜色 Colour
T.RC.RR016-1	粉色 Pink
T.RC.RR016-2	黄色 Yellow
T.RC.RR016-3	绿色 Green
T.RC.RR016-4	黑色 Black
T.RC.RR016-5	红色 Red
T.RC.RR016-6	蓝色 Blue
T.RC.RR016-7	玫红色 Rose red
T.RC.RR016-8	紫色 Purple

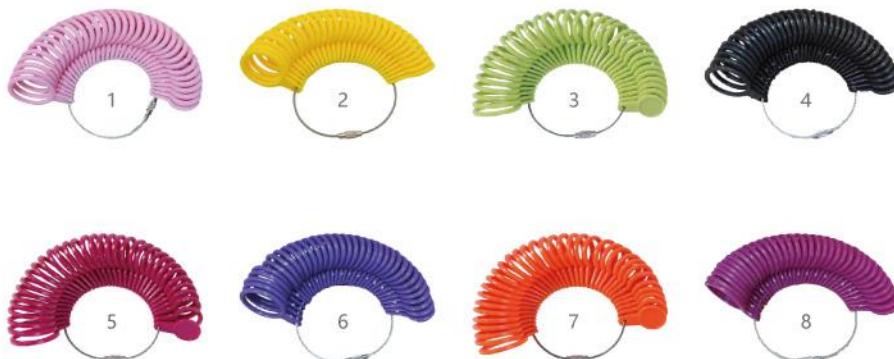

大阳卡尺  
Calipers

代码 Model	显示 Display	读数 Readability	精度 Accuracy
A T.RC.DY001	带表	0-100mm	0.01mm
B T.RC.DY002	带表	0-150mm	0.01mm
C T.RC.DY006	带表	0-200mm	0.01mm
D T.RC.DY004	带表	0-500mm	0.01mm
E T.RC.DY005	数显	0-150mm	0.01mm
F T.RC.DY003	数显	0-100mm	0.01mm

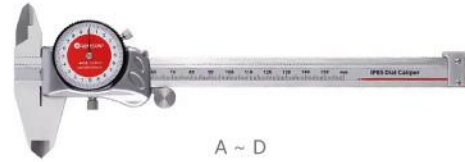

广陆卡尺  
Calipers

代码 Model	显示 Display	读数 Readability	精度 Accuracy
A T.RC.GL001	带表	0-150mm	0.01mm
B T.RC.GL005	带表	0-200mm	0.01mm
C T.RC.GL006	带表	0-300mm	0.01mm
D T.RC.GL003	数显	0-100mm	0.01mm
E T.RC.GL002	数显	0-150mm	0.01mm
F T.RC.GL004	数显	0-200mm	0.01mm

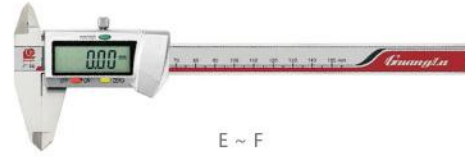
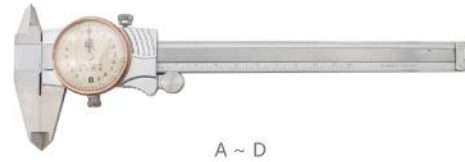

深圳电子卡尺  
Calipers

代码 Model	显示 Display	读数 Readability	精度 Accuracy
A T.RC.SZ001	数显	0-100mm	0.03mm
B T.RC.SZ004	数显	0-150mm	0.03mm
C T.RC.SZ003	数显	0-200mm	0.03mm
D T.RC.SZ005	数显	0-300mm	0.04mm
E T.RC.SZ006	数显	0-100mm	0.03mm
F T.RC.SZ007	数显	0-150mm	0.03mm
G T.RC.SZ008	数显	0-200mm	0.03mm
H T.RC.SZ009	数显	0-300mm	0.04mm
I T.RC.SZ010	全屏	0-150mm	0.03mm
J T.RC.SZ011	全屏	0-200mm	0.03mm
K T.RC.SZ012	全屏	0-300mm	0.04mm

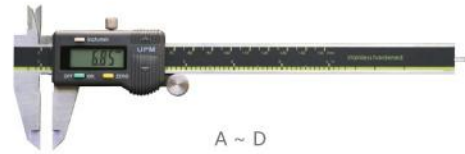

上工卡尺  
Calipers

代码 Model	显示 Display	读数 Readability	精度 Accuracy
T.RC.SG003	带表	0-150mm	0.01mm
T.RC.SG004	带表	0-200mm	0.01mm
T.RC.SG005	带表	0-300mm	0.01mm



日本三丰卡尺  
Calipers

代码 Model	显示 Display	读数 Readability	精度 Accuracy
T.RC.SF001	带表	0-150mm	0.01mm
T.RC.SF002	带表	0-200mm	0.01mm





内卡尺  
Degree gauge  
T.RC.RR026



铜卡尺  
Bass gauge  
T.RC.RR029



测厚仪  
Thickness gauge  
T.RC.F0005  
读数 Readability: 0-12.7mm  
精度 Accuracy: 0.1mm



进口AM电子数显珍珠卡尺  
Alfa Mirage  
T.RC.F0006  
读数 Readability: 0-25mm  
精度 Accuracy: 0.1mm



三用宝石圆形数显卡规  
Digital gem gauge  
T.RC.F0002  
读数 Readability: 0-25mm  
精度 Accuracy: 0.01mm



三用宝石微型数显卡表  
Mini digital gem gauge  
T.RC.F0003  
读数 Readability: 0-25mm  
精度 Accuracy: 0.01mm



圆表千分尺  
Round table micrometer caliper  
T.RC.F0004  
读数 Readability: 0-20mm  
精度 Accuracy: 0.1mm



哈量外径千分尺  
Digital micrometer caliper  
T.RC.HL001  
读数 Readability: 0-25mm



千分尺  
Micrometer caliper  
T.RC.ZX001  
读数 Readability: 0-25mm



头戴式放大镜  
Round table micrometer caliper  
T.DL.H0001



头戴式放大镜  
Digital micrometer caliper  
T.DL.H0003



头戴式放大镜  
Micrometer caliper  
T.DL.H0005



单光放大镜  
LED jewelry loupe

T.DL.780110 10X-21mm  
T.DL.780115 15X-21mm  
T.DL.780120 20X-21mm  
T.DL.780130 30X-21mm



双光放大镜  
LED jewelry loupe

T.DL.780210 10X-21mm  
T.DL.780215 15X-21mm  
T.DL.780220 20X-21mm  
T.DL.780230 30X-21mm  
T.DL.780240 40X-21mm



充电珠宝放大镜  
LED jewelry loupe

T.DL.780410 10X-22mm  
T.DL.780415 15X-22mm  
T.DL.780420 20X-22mm  
T.DL.780430 30X-22mm  
T.DL.780440 40X-22mm



多边珠宝放大镜  
Jewelry loupe

T.DL.7027D 10X-20.5mm  
T.DL.7028D 15X-20.5mm  
T.DL.7029D 20X-20.5mm  
T.DL.7030D 30X-20.5mm



多边金珠宝放大镜  
Jewelry loupe

T.DL.7027C 10X-20.5mm  
T.DL.7028C 15X-20.5mm  
T.DL.7029C 20X-20.5mm  
T.DL.7030C 30X-20.5mm



多边黑珠宝放大镜  
Jewelry loupe

T.DL.7027B 10X-20.5mm  
T.DL.7028B 15X-20.5mm  
T.DL.7029B 20X-20.5mm  
T.DL.7030B 30X-20.5mm



多边亮珠宝放大镜  
Jewelry loupe

T.DL.7027A 10X-20.5mm  
T.DL.7028A 15X-20.5mm  
T.DL.7029A 20X-20.5mm  
T.DL.7030A 30X-20.5mm



多边喷砂珠宝放大镜  
Jewelry loupe

T.DL.7820 10X-20.5mm  
T.DL.7821 15X-20.5mm  
T.DL.7822 20X-20.5mm  
T.DL.7823 30X-20.5mm



拉丝珠宝放大镜  
Jewelry loupe

T.DL.7840 10X-18mm  
T.DL.7841 14X-12mm  
T.DL.7842 20X-12mm



小弧珠宝放大镜  
Jewelry loupe

T.DL.7001A 10X-12mm  
T.DL.7002A 15X-12mm  
T.DL.7003A 20X-12mm



小弧黑珠宝放大镜  
Jewelry loupe

T.DL.7001B 10X-12mm  
T.DL.7002B 15X-12mm  
T.DL.7003B 20X-12mm



小弧金珠宝放大镜  
Jewelry loupe

T.DL.7001C 10X-12mm  
T.DL.7002C 15X-12mm  
T.DL.7003C 20X-12mm



大弧亮珠宝放大镜  
Jewelry loupe

T.DL.7007A 10X-18mm  
T.DL.7008A 15X-18mm  
T.DL.7009A 20X-18mm  
T.DL.7010A 30X-18mm



大弧黑珠宝放大镜  
Jewelry loupe

T.DL.7007B 10X-18mm  
T.DL.7008B 15X-18mm  
T.DL.7009B 20X-18mm  
T.DL.7010B 30X-18mm



大弧金珠宝放大镜  
Jewelry loupe

T.DL.7007C 10X-18mm  
T.DL.7008C 15X-18mm  
T.DL.7009C 20X-18mm  
T.DL.7010C 30X-18mm



大弧胶皮珠宝放大镜  
Jewelry loupe

T.DL.7007D 10X-18mm  
T.DL.7008D 15X-18mm  
T.DL.7009D 20X-18mm  
T.DL.7010D 30X-18mm



珠宝放大镜  
Jewelry loupe

T.DL.7014A 10X-21mm  
T.DL.7015A 15X-21mm  
T.DL.7016A 20X-21mm  
T.DL.7017A 30X-21mm



珠宝放大镜  
Jewelry loupe

T.DL.7014B 10X-21mm  
T.DL.7015B 15X-21mm  
T.DL.7016B 20X-21mm  
T.DL.7017B 30X-21mm



珠宝放大镜  
Jewelry loupe

T.DL.7014C 10X-21mm  
T.DL.7015C 15X-21mm  
T.DL.7016C 20X-21mm  
T.DL.7017C 30X-21mm



珠宝放大镜  
Jewelry loupe

T.DL.7014D 10X-21mm  
T.DL.7015D 15X-21mm  
T.DL.7016D 20X-21mm  
T.DL.7017D 30X-21mm



多边形放大镜  
Jewelry loupe

T.DL.7825 10X-20.5mm  
T.DL.7826 15X-20.5mm  
T.DL.7827 20X-20.5mm  
T.DL.7828 30X-20.5mm



多边形异形胶皮放大镜  
Jewelry loupe

T.DL.7825R 10X-20.5mm  
T.DL.7826R 15X-20.5mm  
T.DL.7827R 20X-20.5mm  
T.DL.7828R 30X-20.5mm

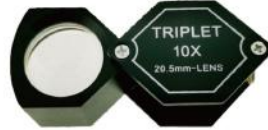

多边形黑异形放大镜  
Jewelry loupe

T.DL.7825B 10X-20.5mm  
T.DL.7826B 15X-20.5mm  
T.DL.7827B 20X-20.5mm  
T.DL.7828B 30X-20.5mm



多边形黑异形胶皮放大镜  
Jewelry loupe

T.DL.7825BR 10X-20.5mm  
T.DL.7826BR 15X-20.5mm  
T.DL.7827BR 20X-20.5mm  
T.DL.7828BR 30X-20.5mm



珠宝放大镜  
Jewelry loupe

T.DL.7021A 10X-18mm  
T.DL.7022A 15X-18mm  
T.DL.7023A 20X-18mm

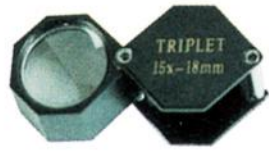

珠宝放大镜  
Jewelry loupe

T.DL.7021B 10X-18mm  
T.DL.7022B 15X-18mm  
T.DL.7023B 20X-18mm



珠宝放大镜  
Jewelry loupe

T.DL.7830  
10X-20.5mm



珠宝放大镜  
Jewelry loupe

T.DL.7036  
10X-21mm, 25X-8mm



珠宝放大镜  
Jewelry loupe

T.DL.7034  
10X-18mm, 20X-12mm



珠宝放大镜  
Jewelry loupe

T.DL.7033  
10X-18mm, 15X-12mm



珠宝放大镜  
Jewelry loupe

T.DL.7055A  
10X, 15X, 20X



珠宝放大镜  
Jewelry loupe

T.DL.7055C  
10X, 15X, 20X



珠宝放大镜  
Jewelry loupe

T.DL.7064A, 10X-12mm  
T.DL.7065A, 10X-14mm  
T.DL.7066A, 10X-15mm



珠宝放大镜  
Jewelry loupe

T.DL.7067A 10X-23mm  
T.DL.7068A 15X-23mm



珠宝放大镜  
Jewelry loupe

T.DL.7070A 10X-18mm  
T.DL.7072A 10X-21mm  
T.DL.7073A 15X-21mm



珠宝放大镜  
Jewelry loupe

T.DL.7812, 10X-18mm  
T.DL.7813, 20X-18mm



珠宝放大镜  
Jewelry loupe

T.DL.7810, 10X-20.5mm



珠宝放大镜  
Jewelry loupe

T.DL.7805, 10X-18mm



珠宝放大镜  
Jewelry loupe

T.DL.7866, 10X-18mm



珠宝放大镜  
Jewelry loupe

T.DL.7888, 10X-21mm



工具放大镜  
Magnifying glass  
T.DL.7095, 15X-18mm



透明座放大镜  
Magnifying glass  
T.DL.7092, 10X-21mm



文镇放大镜  
Magnifying glass  
T.DL.7163, 4x60mm



三角架放大镜  
Magnifying glass  
T.DL.7093, 10x21mm



必佳透明放大镜  
Magnifying glass  
T.DL.7696 10x30mm



切工放大镜  
Magnifying glass  
T.DL.7109



透明座显微镜  
Magnifying glass  
T.DL.7573 50X  
T.DL.7574 75X



折叠式放大镜  
Magnifying glass  
T.DL.7140 6x30mm



折叠式放大镜  
Magnifying glass  
T.DL.7141 6x30mm

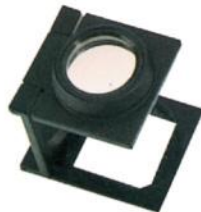

折叠式放大镜  
Magnifying glass  
T.DL.7142 6x21mm



折叠式放大镜  
Magnifying glass  
T.DL.7144 10x14mm



LED折叠式放大镜  
Magnifying glass  
T.DL.7148 6x30mm



腰码放大镜  
Magnifying glass  
T.DL.7105-3 20X



金属腰码放大镜  
Magnifying glass  
T.DL.7106-3 20X



迷你钻石标尺镜  
Magnifying glass  
T.DL.7097 10x17mm



迷你圆筒放大镜  
Magnifying glass  
T.DL.7099 6X



高清圆筒刻度放大镜  
Magnifying glass  
T.DL.7013 10x18mm  
T.DL.7014 15x18mm  
T.DL.7015 20x18mm  
T.DL.7016 30x18mm



手持式放大镜  
Magnifying glass  
T.DL.7123 10x21mm



暗视场宝石放大镜  
Magnifying glass  
T.DL.7201



LED暗视场宝石放大镜  
Magnifying glass  
T.DL.7220



大标尺放大镜  
Magnifying glass  
T.DL.7173 10x25mm



小标尺放大镜  
Magnifying glass  
T.DL.7170 7x21mm 10x21mm



LED刻度放大镜  
Magnifying glass  
T.DL.7174



充电标尺放大镜  
Magnifying glass  
T.DL.7178 10x30mm  
T.DL.7179 15x30mm



LED小套装刻度放大镜  
Magnifying glass  
T.DL.7172



LED大套装刻度放大镜  
Magnifying glass  
T.DL.7175



LED偏光镜  
Polarizing filter  
T.DL.7221



偏光镜  
Polarizing filter  
T.DL.7202



台式偏光镜  
Polarizing filter  
T.DL.7311



查尔斯双片滤色镜  
Color filter  
T.DL.7811 15x21mm



翡翠滤色镜  
Color filter  
T.DL.7300



翡翠滤色镜  
Color filter  
T.DL.7300-B



查尔斯滤色镜  
Color filter  
T.DL.7301



查尔斯滤色镜  
Color filter  
T.DL.7301B



红宝石滤色镜  
Color filter  
T.DL.7302



偏光(新)二色镜  
Color filter  
T.DL.7209



宝石分光镜  
Spektroskop gemological arac  
T.DL.7207



宝石二色镜  
Spektroskop gemological arac  
T.DL.7208



棱镜分光镜  
Spektroskop gemological arac  
T.DL.7204



银色光栅分光镜  
Spektroskop gemological arac  
T.DL.7206



调焦分光镜  
Spektroskop gemological arac  
T.DL.7208

显微镜镊子  
Wire gem clamp with mounting post



T.DL.7340



T.DL.7343



T.DL.7344



精品显微镜  
Microscope  
T.DL.7503 20X  
T.DL.7504 40X  
T.DL.7505 60X  
T.DL.7506 100X



LED精品显微镜  
Microscope  
T.DL.7515 20X  
T.DL.7516 40X  
T.DL.7517 60X  
T.DL.7518 100X



充电精品显微镜  
Microscope  
T.DL.7525 20X  
T.DL.7526 40X  
T.DL.7527 60X  
T.DL.7528 100X



小精品显微镜  
Microscope  
T.DL.7511 50X  
T.DL.7513 100X



手持显微镜  
Microscope  
T.DL.7582 50X  
T.DL.7585 75X



笔式显微镜(带刻度)  
Microscope  
T.DL.7592 50X  
T.DL.7593 100X

笔式显微镜  
Microscope  
T.DL.7596 50X  
T.DL.7598 100X

双目暗视场显微镜  
Binocular hint field microscope



T.DL.ZTXE-ZB



T.DL.ZTXE-ZB

产品型号配置表 SPECIFICATIONS LIST

配置项目 Component	规格 Specifications	T.DL.ZTXE-ZB	T.DL.ZTXE-ZB
机头 Viewing Head	双目 Inclined binocular	●	●
	三目 Inclined trinocular	○	
	机头360°旋转 360° rotatable	●	●
目镜 Eyepiece	SWF10X	●	
	HWF10X	○	
	WF15X	○	○
	WF20X	○	○
物镜 Objective	0.67X~4.5X		
	1X-4X	●	
	2X/4X		●
	1X/3X		○
	1X/2X		○
照射光 Incident Light	12V10W卤素灯 12V10W halogen light	●	●
	10W荧光灯 10W fluorescent light	●	○
	单束光纤 Single fiber		
透射光 Transmitted light	12V10W卤素灯 12V10W halogen light	●	●
附件 Attachment	珠宝钳 Jewel tweezer	●	●
	珠宝工作台 (带光栏) Darkfield working stage (with diaphragm)	●	●
调光装置 Light-dimmer	拨盘调光 Dial dimmer switch	●	●
数码接口 Camera Interface	C型 CType		
	H型 HType		

注: ● 标准配置 standard ○ 选购配置 Optiona

双目定位显微镜  
Microscope



产品型号配置表 SPECIFICATIONS LIST

配置项目 Component	规格 Specifications	T.DL.ZTX-E-C3	T.DL.ZTX-E	T.DL.ZTX-3E	T.DL.ZTX-3E-C3
观察头 Viewing Head	双目立体45° Binocular stereo 45°	•	•		
	三目立体45° Three-eye stereo 45°			•	•
瞳距调节 Interpupillary distance	55mm-75mm	•	•	•	•
目镜 Eyepiece	SWF10X/22mm	•	•	•	•
	WF15X/15mm	○	○	○	○
	WF20X/10mm	○	○	○	○
物镜 Objective	1X-4X	•	•	•	•
工作距离 Working Distance	91mm	•	•	•	•
机座 Base	圆立柱 Circinal pillar	•	•	•	•
	方立柱 Quadrate pillar				•
	扇形底座 Fan-shaped	•	•	•	
	方底座 Square				•
照明系统 Illumination	上下光卤素灯 Halogen light	•	•	•	•
	双支LED软管灯 Dual goose LED light		○	○	
调光方式 Light-dimmer	旋钮式调光 Knob dimmer switch	○	○	○	○
	拨盘式调光 Dial dimmer switch	•	•	•	•
相机接口 The camera interface	H型 H Type			•	•
	C型 C Type			○	○

注：• 标准配置 standard ○ 选购配置 Optiona (可选配件：电子目镜 Optional Accessory: CCD)

显微镜  
Microscope



T.DL.XTX-5B



T.DL.XTX-5C



T.DL.XTX-6CW



T.DL.XTX-7CW

产品型号配置表 SPECIFICATIONS LIST

配置项目 Component	规格 Specifications	T.DL.XTX-5B	T.DL.XTX-5C	T.DL.XTX-6CW	T.DL.XTX-7CW
观察头 Viewing Head	双目45°瞳距55-76mm 头部旋转 45° inclined binocular head, interpupillary distance is from 55mm to 76mm	●	●	●	●
	WF10X/20mm	●	●	●	●
目镜 Eyepiece	WF15X/15mm	○	○	○	○
	WF20X/10mm	○	○	○	○
物镜 Objective	2X/4X	●	●	●	●
	1X/3X	○	○	○	○
工作距离 Working Distance	1X/2X	○	○	○	○
	76mm	●	●	●	●
机座 Base	圆立柱 Circinal pilar	●	●		
	方立柱 Quadrate pillar			●	●
	无光源 No				
调光方式 Light-dimmer	LED上下光源 LED	●	●	●	●
	上下光卤素灯 Halogen light	○	○	○	○
调光方式 Light-dimmer	旋钮式调光 Knob dimmer switch	○	○	○	○
	拨盘式调光 Dial dimmer switch	○	○	●	●

注：● 标准配置 standard ○ 选购配置 Optiona

型号 Model	T.DL.YH01A	T.DL.YH01B
放大倍数 Magnification	7X-45X	7X-45X
目镜 Eyepiece	WF10X	WF10X
镜头 Lenses	0.5X	0.5X
真实视角 Real Angle of View	45°	45°
工作距离 Working Distance	100mm, 165mm with 0.5X	100mm, 165mm with 0.5X
屏幕 Screen	/	10.1 INCH
运输尺寸 Shipping Dimension	49x37x36cm	49x37x36cm
整机重量 Gross Weight	11.5kg	12.2kg



型号 Model	T.DL.YH02A	T.DL.YH02B
放大倍数 Magnification	7X-45X	7X-45X
目镜 Eyepiece	WF10X	WF10X
镜头 Lenses	0.5X	0.5X
真实视角 Real Angle of View	45°	45°
工作距离 Working Distance	100mm, 165mm with 0.5X	100mm, 165mm with 0.5X
屏幕 Screen	/	10.1 INCH
运输尺寸 Shipping Dimension	45x31x33.5cm	45x31x33.5cm
整机重量 Gross Weight	12kg	13kg

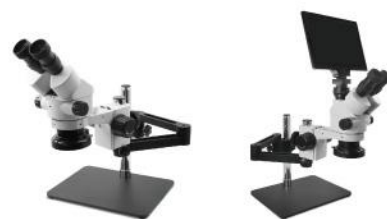

型号 Model	T.DL.YH03A	T.DL.YH03B
放大倍数 Magnification	7X-45X	7X-45X
目镜 Eyepiece	WF10X	WF10X
镜头 Lenses	0.5X	0.5X
真实视角 Real Angle of View	45°	45°
工作距离 Working Distance	100mm, 165mm with 0.5X	100mm, 165mm with 0.5X
屏幕 Screen	/	10.1 INCH
运输尺寸 Shipping Dimension	36.5x30.5x31.5cm	36.5x30.5x39cm
整机重量 Gross Weight	11kg	12kg



型号 Model	T.DL.YH05A	T.DL.YH05B
放大倍数 Magnification	7X-45X	7X-45X
目镜 Eyepiece	WF10X	WF10X
镜头 Lenses	0.5X	0.5X
真实视角 Real Angle of View	45°	45°
工作距离 Working Distance	100mm, 165mm with 0.5X	100mm, 165mm with 0.5X
屏幕 Screen	/	10.1 INCH
运输尺寸 Shipping Dimension	45x24x37.5cm	45x24x37.5cm
整机重量 Gross Weight	6.9kg	8.1kg



型号 Model	T.DL.YH06A	T.DL.YH06B
放大倍数 Magnification	7X-45X	7X-45X
目镜 Eyepiece	WF10X	WF10X
镜头 Lenses	0.5X	0.5X
真实视角 Real Angle of View	45°	45°
工作距离 Working Distance	100mm, 165mm with 0.5X	100mm, 165mm with 0.5X
屏幕 Screen	/	10.1 INCH
运输尺寸 Shipping Dimension	50x49x29cm	450x49x38cm
整机重量 Gross Weight	22.5kg	24kg



型号 Model	T.DL.YS01A	T.DL.YH01B
放大倍数 Magnification	7X-45X	7X-45X
目镜 Eyepiece	WF10X	WF10X
镜头 Lenses	0.5X	0.5X
真实视角 Real Angle of View	45°	45°
工作距离 Working Distance	100mm, 165mm with 0.5X	100mm, 165mm with 0.5X
屏幕 Screen	/	10.1 INCH
运输尺寸 Shipping Dimension	48x50x24cm	48x50x24cm
整机重量 Gross Weight	8.8kg	10kg



型号 Model	T.DL.YS02A	T.DL.YS02B
放大倍数 Magnification	7X-45X	7X-45X
目镜 Eyepiece	WF10X	WF10X
镜头 Lenses	0.5X	0.5X
真实视角 Real Angle of View	45°	45°
工作距离 Working Distance	100mm, 165mm with 0.5X	100mm, 165mm with 0.5X
屏幕 Screen	/	10.1 INCH
运输尺寸 Shipping Dimension	33x36x33cm	33x36x33cm
整机重量 Gross Weight	8.5kg	10kg



型号 Model	T.DL.YS03A	T.DL.YS03B
放大倍数 Magnification	7X-45X	7X-45X
目镜 Eyepiece	WF10X	WF10X
镜头 Lenses	0.5X	0.5X
真实视角 Real Angle of View	45°	45°
工作距离 Working Distance	100mm, 165mm with 0.5X	100mm, 165mm with 0.5X
屏幕 Screen	/	10.1 INCH
运输尺寸 Shipping Dimension	41.5x25x42cm	41.5x25x51cm
整机重量 Gross Weight	9.3kg	10.3kg



型号 Model	T.DL.YS04A	T.DL.YS04B
放大倍数 Magnification	7X-45X	7X-45X
目镜 Eyepiece	WF10X	WF10X
真实视角 Real Angle of View	45°	45°
工作距离 Working Distance	100mm	100mm, 165mm with 0.5X
屏幕 Screen	/	10.1 INCH
运输尺寸 Shipping Dimension	51x36x30cm	51x36x38cm
整机重量 Gross Weight	6.3kg	10.3kg



型号 Model	T.DL.YS05A
放大倍数 Magnification	20X, 40X
目镜 Eyepiece	WF10X
真实视角 Real Angle of View	45°
工作距离 Working Distance	55-75mm
屏幕 Screen	/
运输尺寸 Shipping Dimension	46x34x20cm
整机重量 Gross Weight	3kg



型号 Model	T.D.LYS06A	T.D.LYS06B
放大倍数 Magnification	7X-45X	7X-45X
目镜 Eyepiece	WF10X	WF10X
真实视角 Real Angle of View	45°	45°
工作距离 Working Distance	100mm	100mm
屏幕 Screen	/	10.1 INCH
运输尺寸 Shipping Dimension	51x36x30cm	51x36x38cm
整机重量 Gross Weight	6.2kg	7.4kg



电子称  
Electronic scales

代码 Model	称量 Capacity	秤台尺寸 Platform size	精度 Accuracy
M.ES.A0300-B	300g	Φ85mm	0.01g
M.ES.A0500-B	500g	Φ85mm	0.01g
M.ES.A0600-B	600g	Φ85mm	0.01g
M.ES.A1000-B	1000g	Φ85mm	0.01g
M.ES.A1200-B	1200g	Φ85mm	0.01g
M.ES.A2000-B	2000g	Φ85mm	0.01g
M.ES.A3000-B	3000g	Φ85mm	0.01g
M.ES.A5000-B	5000g	Φ85mm	0.01g



电子称  
Electronic scales

代码 Model	称量 Capacity	秤台尺寸 Platform size	精度 Accuracy	外形尺寸 Dimensions
M.ES.A0300-C	300g	Φ85mm	0.01g	280×188×170mm
M.ES.A0500-C	500g	Φ85mm	0.01g	280×188×170mm
M.ES.A0600-C	600g	Φ85mm	0.01g	280×188×170mm
M.ES.A1000-C	1000g	Φ85mm	0.01g	280×188×170mm
M.ES.A1200-C	1200g	Φ85mm	0.01g	280×188×170mm
M.ES.A2000-C	2000g	Φ85mm	0.01g	280×188×170mm
M.ES.A3000-C	3000g	Φ85mm	0.01g	280×188×170mm
M.ES.A5000-C	5000g	Φ85mm	0.01g	280×188×170mm



电子称  
Electronic scales

代码 Model	称量 Capacity	秤台尺寸 Platform size	精度 Accuracy	外形尺寸 Dimensions
M.ES.A0100	120g	Φ130mm	0.001g	280×188×170mm
M.ES.A0200	200g	Φ130mm	0.001g	280×188×170mm
M.ES.A0300	300g	Φ130mm	0.001g	280×188×170mm



## 电子称

## Electronic scales

代码 Model	称量 Capacity	秤台尺寸 Platform size	精度 Accuracy	外形尺寸 Dimensions
M.ES.A2000	2000g	160×160mm	0.1g	280×188×80mm
M.ES.A3000	3000g	160×160mm	0.1g	280×188×80mm
M.ES.A5000	5000g	160×160mm	0.1g	280×188×80mm
M.ES.A6000	6000g	160×160mm	0.1g	280×188×80mm
M.ES.10000	10000g	160×160mm	0.1g	280×188×80mm



## 电子称

## Electronic scales

代码 Model	称量 Capacity	秤台尺寸 Platform size	精度 Accuracy
M.ES.A0600-E	600g	Φ85mm	0.01g
M.ES.A1200-E	1200g	Φ85mm	0.01g
M.ES.A2000-E	2000g	Φ85mm	0.01g
M.ES.A3000-E	3000g	Φ85mm	0.01g



## 电子称

## Electronic scales

代码 Model	称量 Capacity	秤台尺寸 Platform size	精度 Accuracy	外形尺寸 Dimensions
M.ES.A0300-F	300g	Φ120mm	0.01g	270×170×80mm
M.ES.A0500-F	500g	Φ120mm	0.01g	270×170×80mm
M.ES.A0600-F	600g	Φ120mm	0.01g	270×170×80mm
M.ES.A1000-F	1000g	Φ120mm	0.01g	270×170×80mm
M.ES.A1200-F	1200g	Φ120mm	0.01g	270×170×80mm



## 电子称

## Electronic scales

代码 Model	称量 Capacity	秤台尺寸 Platform size	精度 Accuracy	外形尺寸 Dimensions
M.ES.F0120-I	120g	Φ120mm	0.001g	270×170×80mm
M.ES.F0220-I	220g	Φ120mm	0.001g	270×170×80mm
M.ES.F0320-I	320g	Φ120mm	0.001g	270×170×80mm
M.ES.F0320-I	520g	Φ120mm	0.001g	270×170×80mm



## 电子称

## Electronic scales

## 外校 External correction

代码 Model	称量 Capacity	秤台尺寸 Platform size	精度 Accuracy	外形尺寸 Dimensions
M.ES.FA1004X	100g	Φ90mm	0.1mg	320×212×350mm
M.ES.FA1204X	120g	Φ90mm	0.1mg	320×212×350mm
M.ES.FA2004X	200g	Φ90mm	0.1mg	320×212×350mm
M.ES.FA2204X	220g	Φ90mm	0.1mg	320×212×350mm
M.ES.FA3004X	300g	Φ90mm	0.1mg	320×212×350mm
M.ES.FA3204X	320g	Φ90mm	0.1mg	320×212×350mm



## 电子称 Electronic scales

内校 Internal correction

代码 Model	称量 Capacity	秤台尺寸 Platform size	精度 Accuracy	外形尺寸 Dimensions
M.ES.FA1004XN	100g	Φ90mm	0.1mg	320×212×350mm
M.ES.FA1204XN	120g	Φ90mm	0.1mg	320×212×350mm
M.ES.FA2004XN	200g	Φ90mm	0.1mg	320×212×350mm
M.ES.FA2204XN	220g	Φ90mm	0.1mg	320×212×350mm
M.ES.FA3004XN	300g	Φ90mm	0.1mg	320×212×350mm
M.ES.FA3204XN	320g	Φ90mm	0.1mg	320×212×350mm



## 电子称 Electronic scales

外校 External correction

代码 Model	称量 Capacity	秤台尺寸 Platform size	精度 Accuracy	外形尺寸 Dimensions	重量 Weight
M.ES.FA1004C	100g	Φ80mm	0.1mg	320×212×350mm	5.5kg
M.ES.FA1204C	120g	Φ80mm	0.1mg	320×212×350mm	5.5kg
M.ES.FA2004C	200g	Φ80mm	0.1mg	320×212×350mm	5.5kg
M.ES.FA2204C	220g	Φ80mm	0.1mg	320×212×350mm	5.5kg
M.ES.FA3004C	300g	Φ80mm	0.1mg	320×212×350mm	5.5kg
M.ES.FA3204C	320g	Φ80mm	0.1mg	320×212×350mm	5.5kg



## 电子称 Electronic scales

内校 Internal correction

代码 Model	称量 Capacity	秤台尺寸 Platform size	精度 Accuracy	外形尺寸 Dimensions	重量 Weight
M.ES.FA1004CN	100g	Φ80mm	0.1mg	320×212×350mm	5.5kg
M.ES.FA1204CN	120g	Φ80mm	0.1mg	320×212×350mm	5.5kg
M.ES.FA2004CN	200g	Φ80mm	0.1mg	320×212×350mm	5.5kg
M.ES.FA2204CN	220g	Φ80mm	0.1mg	320×212×350mm	5.5kg
M.ES.FA3004CN	300g	Φ80mm	0.1mg	320×212×350mm	5.5kg
M.ES.FA3204CN	320g	Φ80mm	0.1mg	320×212×350mm	5.5kg



## 电子称 Electronic scales

代码 Model	称量 Capacity	秤台尺寸 Platform size	精度 Accuracy	外形尺寸 Dimensions	重量 Weight
M.ES.TD2002D	200g	Φ125mm	0.01g	290×185×80mm	1.8kg
M.ES.TD5002D	500g	Φ125mm	0.01g	290×185×80mm	1.8kg
M.ES.TD10002D	1000g	Φ125mm	0.01g	290×185×80mm	1.8kg
M.ES.TD20002D	2000g	Φ125mm	0.01g	290×185×80mm	1.8kg



## 电子称 Electronic scales

代码 Model	称量 Capacity	秤台尺寸 Platform size	精度 Accuracy	外形尺寸 Dimensions	重量 Weight
M.ES.TD30002D	3000g	170×170mm	0.01g	290×185×80mm	2.2kg
M.ES.TD50002D	5000g	170×170mm	0.01g	290×185×80mm	2.2kg



### 电子称 Electronic scales

代码 Model	称量 Capacity	秤台尺寸 Platform size	精度 Accuracy	外形尺寸 Dimensions	重量 Weight
M.ES.TD2002A	200g	155×143mm	0.01g	265×200×80mm	1.2kg
M.ES.TD5002A	500g	155×143mm	0.01g	265×200×80mm	1.2kg
M.ES.TD10002A	1000g	155×143mm	0.01g	265×200×80mm	1.2kg
M.ES.TD20002A	2000g	155×143mm	0.01g	265×200×80mm	1.2kg
M.ES.TD30002A	3000g	155×143mm	0.01g	265×200×80mm	1.2kg
M.ES.TD50002A	5000g	155×143mm	0.01g	265×200×80mm	1.2kg



### 电子称 Electronic scales

数码显示 Digital display

代码 Model	称量 Capacity	秤台尺寸 Platform size	精度 Accuracy	外形尺寸 Dimensions	重量 Weight
M.ES.YP2002	200g	125×163mm	0.01g	225×220×80mm	1.2kg
M.ES.YP5002	500g	125×163mm	0.01g	225×220×80mm	1.2kg
M.ES.YP6002	600g	125×163mm	0.01g	225×220×80mm	1.2kg
M.ES.YP10002	1000g	125×163mm	0.01g	225×220×80mm	1.2kg
M.ES.YP20002	2000g	125×163mm	0.01g	225×220×80mm	1.2kg
M.ES.YP30002	3000g	125×163mm	0.01g	225×220×80mm	1.2kg



### 电子称 Electronic scales

液晶显示 LED

代码 Model	称量 Capacity	秤台尺寸 Platform size	精度 Accuracy	外形尺寸 Dimensions	重量 Weight
M.ES.YP2002D	200g	125×163mm	0.01g	225×220×80mm	1.2kg
M.ES.YP5002D	500g	125×163mm	0.01g	225×220×80mm	1.2kg
M.ES.YP6002D	600g	125×163mm	0.01g	225×220×80mm	1.2kg
M.ES.YP10002D	1000g	125×163mm	0.01g	225×220×80mm	1.2kg
M.ES.YP20002D	2000g	125×163mm	0.01g	225×220×80mm	1.2kg
M.ES.YP30002D	3000g	125×163mm	0.01g	225×220×80mm	1.2kg
M.ES.YP50002D	5000g	125×163mm	0.01g	225×220×80mm	1.2kg



### 电子称 Electronic scales

代码 Model	称量 Capacity	秤台尺寸 Platform size	精度 Accuracy	外形尺寸 Dimensions	重量 Weight
M.ES.YP2002S	200g	143×192mm	0.01g	225×220×80mm	1.2kg
M.ES.YP5002S	500g	143×192mm	0.01g	225×220×80mm	1.2kg
M.ES.YP6002S	600g	143×192mm	0.01g	225×220×80mm	1.2kg
M.ES.YP10002S	1000g	143×192mm	0.01g	225×220×80mm	1.2kg
M.ES.YP20002S	2000g	143×192mm	0.01g	225×220×80mm	1.2kg
M.ES.YP30002S	3000g	143×192mm	0.01g	225×220×80mm	1.2kg



### 手掌称 Pocket digital scale

代码 Model	称量 Capacity	精度 Accuracy	外形尺寸 Dimensions
M.ES.F0100-F	100g	0.01g	128×78×19mm
M.ES.F0200-F	200g	0.01g	128×78×19mm
M.ES.F0300-F	300g	0.01g	128×78×19mm
M.ES.F0500-F	500g	0.01g	128×78×19mm
M.ES.F1000-F	1000g	0.01g	128×78×19mm



## 手掌称 Pocket digital scale

代码 Model	称量 Capacity	精度 Accuracy	外形尺寸 Dimensions
M.ES.F0100-E	100g	0.01g	123×73×34mm
M.ES.F0200-E	200g	0.01g	123×73×34mm
M.ES.F0300-E	300g	0.01g	123×73×34mm
M.ES.F0500-E	500g	0.01g	123×73×34mm



## 手掌称 Pocket digital scale

代码 Model	称量 Capacity	精度 Accuracy	外形尺寸 Dimensions
M.ES.F0200-H	200g	0.01g	165×104×23mm
M.ES.F0300-H	300g	0.01g	165×104×23mm
M.ES.F0500-H	500g	0.01g	165×104×23mm
M.ES.F1000-H	1000g	0.1g	165×104×23mm
M.ES.F2000-H	2000g	0.1g	165×104×23mm



## 手掌称 Pocket digital scale

代码 Model	称量 Capacity	精度 Accuracy	外形尺寸 Dimensions
M.ES.F0200-G	200g	0.01g	166×111×22mm
M.ES.F0300-G	300g	0.01g	166×111×22mm
M.ES.F0500-G	500g	0.01g	166×111×22mm
M.ES.F1000-G	1000g	0.1g	166×111×22mm
M.ES.F2000-G	2000g	0.1g	166×111×22mm



## 手掌称 Pocket digital scale

代码 Model	称量 Capacity	精度 Accuracy	外形尺寸 Dimensions
M.ES.F0100-B	100g	0.01g	112×73×15mm
M.ES.F0200-B	200g	0.01g	112×73×15mm
M.ES.F0200-B2	500g	0.1g	112×73×15mm



## 手掌称 Pocket digital scale

代码 Model	称量 Capacity	精度 Accuracy	外形尺寸 Dimensions
M.ES.F0200-J	200g	0.01g	140×85×24mm
M.ES.F0300-J	300g	0.01g	140×85×24mm
M.ES.F0500-J	500g	0.01g	140×85×24mm
M.ES.F0600-J	600g	0.01g	140×85×24mm
M.ES.F1000-J	1000g	0.1g	140×85×24mm



手掌称  
Pocket digital scale

代码 Model	称量 Capacity	秤台尺寸 Platform size	精度 Accuracy	外形尺寸 Dimensions
M.ES.F0050-I	50g	Φ68.6mm	0.001g	132.1×94×58.4mm
M.ES.F0100-I-1	100g	Φ68.6mm	0.001g	132.1×94×58.4mm
M.ES.F0100-I-2	100g	Φ68.6mm	0.002g	132.1×94×58.4mm



手掌称  
Pocket digital scale

代码 Model	称量 Capacity	精度 Accuracy	外形尺寸 Dimensions
M.ES.F0100-K	100g	0.01g	118×80×23mm
M.ES.F0200-K	200g	0.01g	118×80×23mm
M.ES.F0300-K	300g	0.01g	118×80×23mm
M.ES.F0500-K-1	500g	0.01g	118×80×23mm
M.ES.F0500-K-2	500g	0.1g	118×80×23mm



手掌称  
Pocket digital scale

代码 Model	称量 Capacity	秤台尺寸 Platform size	精度 Accuracy	外形尺寸 Dimensions
M.ES.F0100-M	100g	62.2×53.7mm	0.01g	160×68×20mm
M.ES.F0200-M	200g	62.2×53.7mm	0.01g	160×68×20mm
M.ES.F0300-M	300g	62.2×53.7mm	0.01g	160×68×20mm
M.ES.F0500-M-1	500g	62.2×53.7mm	0.01g	160×68×20mm
M.ES.F0500-M-2	500g	62.2×53.7mm	0.1g	160×68×20mm
M.ES.F1000-M	1000g	62.2×53.7mm	0.1g	160×68×20mm



手掌称  
Pocket digital scale

代码 Model	称量 Capacity	秤台尺寸 Platform size	精度 Accuracy	外形尺寸 Dimensions
M.ES.F0100-N	100g	160×68×20mm	0.01g	160×68×20mm
M.ES.F0200-N	200g	160×68×20mm	0.01g	160×68×20mm
M.ES.F0300-N	300g	160×68×20mm	0.01g	160×68×20mm
M.ES.F0500-N-1	500g	160×68×20mm	0.01g	160×68×20mm
M.ES.F0500-N-2	500g	160×68×20mm	0.1g	160×68×20mm
M.ES.F1000-N	1000g	160×68×20mm	0.1g	160×68×20mm



手掌称  
Pocket digital scale

代码 Model	称量 Capacity	精度 Accuracy	外形尺寸 Dimensions
M.ES.F0100-O	100g	0.01g	81×62×23mm
M.ES.F0200-O	200g	0.01g	81×62×23mm



**手掌称**  
Pocket digital scale

代码 Model	称量 Capacity	秤台尺寸 Platform size	精度 Accuracy	外形尺寸 Dimensions
M.ES.F0100-1	100g	75×63mm	0.01g	120×75×19mm
M.ES.F0200-C	200g	75×63mm	0.01g	120×75×19mm
M.ES.F0300-A	300g	75×63mm	0.01g	120×75×19mm
M.ES.F0500-1	500g	75×63mm	0.01g	120×75×19mm
M.ES.F0500-B	500g	75×63mm	0.1g	120×75×19mm
M.ES.F1000-1	1000g	75×63mm	0.1g	120×75×19mm



**手掌称**  
Pocket digital scale

代码 Model	称量 Capacity	精度 Accuracy	外形尺寸 Dimensions
M.ES.F0100-P	100g	0.01g	114×76×19.5mm
M.ES.F0200-P	200g	0.01g	114×76×19.5mm
M.ES.F0300-P	300g	0.01g	114×76×19.5mm
M.ES.F0500-P-1	500g	0.01g	114×76×19.5mm
M.ES.F0500-P-2	500g	0.1g	114×76×19.5mm
M.ES.F1000-P	1000g	0.1g	114×76×19.5mm



**手掌称**  
Pocket digital scale

代码 Model	称量 Capacity	精度 Accuracy	外形尺寸 Dimensions
M.ES.F0500-Q	500g	0.01g	165×100×20mm
M.ES.F2000-Q	2000g	0.1g	165×100×20mm



**手掌称**  
Pocket digital scale

代码 Model	称量 Capacity	精度 Accuracy	外形尺寸 Dimensions
M.ES.F0500-R	500g	0.01g	112×85×23mm
M.ES.F1000-R	1000g	0.01g	112×85×23mm
M.ES.F2000-R	2000g	0.1g	112×85×23mm



**手掌称**  
Pocket digital scale

代码 Model	称量 Capacity	精度 Accuracy	外形尺寸 Dimensions
M.ES.F0100-S	100g	0.01g	72×120×20mm
M.ES.F0200-S	200g	0.01g	72×120×20mm
M.ES.F0300-S	300g	0.01g	72×120×20mm
M.ES.F0500-S-1	500g	0.01g	72×120×20mm
M.ES.F0500-S-2	500g	0.1g	72×120×20mm
M.ES.F1000-S	1000g	0.1g	72×120×20mm



手掌称  
Pocket digital scale

代码 Model	称量 Capacity	精度 Accuracy	外形尺寸 Dimensions
M.ES.F0600-T	600g	0.01g	165×115×20mm
M.ES.F1000-T	1000g	0.1g	165×115×20mm
M.ES.F2000-T	2000g	0.1g	165×115×20mm
M.ES.F3000-T	3000g	0.1g	165×115×20mm



手掌称  
Pocket digital scale

代码 Model	称量 Capacity	秤台尺寸 Platform size	精度 Accuracy	外形尺寸 Dimensions	重量 Weight
M.ES.F0600-U	600g	100×100mm	0.01g	142×100×15mm	302g
M.ES.F1000-U	1000g	100×100mm	0.1g	142×100×15mm	302g
M.ES.F2000-U	2000g	100×100mm	0.1g	142×100×15mm	302g
M.ES.F3000-U	3000g	100×100mm	0.1g	142×100×15mm	302g



手掌称  
Pocket digital scale

代码 Model	称量 Capacity	精度 Accuracy	外形尺寸 Dimensions
M.ES.F0100-V	100g	0.01g	90×50×14mm
M.ES.F0200-V	200g	0.01g	90×50×14mm
M.ES.F0300-V	500g	0.1g	90×50×14mm



手掌称  
Pocket digital scale

代码 Model	称量 Capacity	精度 Accuracy	外形尺寸 Dimensions
M.ES.F0100-W	100g	0.01g	70×40×10mm
M.ES.F0200-W	200g	0.01g	70×40×10mm



手掌称  
Pocket digital scale

代码 Model	称量 Capacity	精度 Accuracy	外形尺寸 Dimensions
M.ES.F0100-X	100g	0.01g	70×40×10mm
M.ES.F0200-X	200g	0.01g	70×40×10mm



手掌称  
Pocket digital scale

代码 Model	称量 Capacity	精度 Accuracy	外形尺寸 Dimensions
M.ES.F0100-X	100g	0.01g	70×40×10mm
M.ES.F0200-X	200g	0.01g	70×40×10mm



手掌称  
Pocket digital scale

代码 Model	称量 Capacity	精度 Accuracy	外形尺寸 Dimensions
M.ES.F0500-Z	500g	0.01g	Φ90mm
M.ES.F1000-Z	1000g	0.1g	Φ90mm
M.ES.F2000-Z	2000g	0.1g	Φ90mm



手掌称  
Pocket digital scale

代码 Model	称量 Capacity	秤台尺寸 Platform size	精度 Accuracy	外形尺寸 Dimensions
M.ES.F0100-1	100g	58×58mm	0.01g	140×84×23mm
M.ES.F0200-1	200g	58×58mm	0.01g	140×84×23mm
M.ES.F0500-1	500g	58×58mm	0.01g	140×84×23mm
M.ES.F1000-1	1000g	58×58mm	0.1g	140×84×23mm
M.ES.F2000-1	2000g	58×58mm	0.1g	140×84×23mm



手掌称  
Pocket digital scale

代码 Model	称量 Capacity	秤台尺寸 Platform size	精度 Accuracy	外形尺寸 Dimensions
M.ES.F0100-2	100g	58×58mm	0.01g	140×84×23mm
M.ES.F0200-2	200g	58×58mm	0.01g	140×84×23mm
M.ES.F0500-2	500g	58×58mm	0.01g	140×84×23mm
M.ES.F1000-2	1000g	58×58mm	0.1g	140×84×23mm
M.ES.F2000-2	2000g	58×58mm	0.1g	140×84×23mm



手掌称  
Pocket digital scale

代码 Model	称量 Capacity	秤台尺寸 Platform size	精度 Accuracy	外形尺寸 Dimensions
M.ES.F0500-Z	100g	50×40mm	0.01g	90×50×18mm
M.ES.F1000-Z	200g	50×40mm	0.01g	90×50×18mm



## 测金机 (水密度计)

## Gold detecting machine (water density meter)

主要针对珠宝业、珠宝检测中心、银行业、典当业、矿业、贵金属回收、贵金属材料研究实验室等领域，快速的显示贵金属K值、%含量、密度值。

The instrument serves jewelry industry, jewelry testing centers, banking, pawnbroking, mining, precious metal recovery, and precious metal research laboratories, providing rapid display of karat value (K), percentage purity (%), and density value for precious metals.



型号 Model	M.RH.AR300K	M.RH.AR600K	M.RH.AR900K	M.RH.AR120K	M.RH.AR1200K	M.RH.AR1200K
最大称重 Max weight	300g	600g	900g	120g	1200g	2000g
电压 Voltage	AC100V~240V 50HZ/60HZ					
称重标准偏差 Weighing standard deviation	0.005g	0.005g	0.01g	0.001g	0.01g	0.01g
最小测量产品参考重量 Mini measured product reference weight	4g	4g	5g	2g	5g	5g
密度可读性 Density readability	0.001g/cm <sup>3</sup>	0.001g/cm <sup>3</sup>	0.001g/cm <sup>3</sup>	0.0001g/cm <sup>3</sup>	0.01g/cm <sup>3</sup>	0.01g/cm <sup>3</sup>
水槽尺寸 Tank size	153×107×93mm					
机器尺寸 Machine size	425×175×325mm					
重量 Weight	4.5KG					

## 密度计

## Density meter

主要针对高分子聚合物领域的密度测量，密度精度高，即时显示密度值，操作顺畅方便、省时，具有更好的测量稳定性与可靠性，适合要求较高的场合。

Primarily designed for density measurement in the polymer materials field, it delivers high-density precision, instant display of density values, smooth and user-friendly operation, and time-efficient workflows. It features enhanced measurement stability and reliability, making it suitable for demanding applications.



型号 Model	M.RH.DH300	M.RH.DH600	M.RH.DH900	M.RH.DH1200	M.RH.DH2000	M.RH.DH3000	M.RH.DE120	M.RH.DE200
最大称重 Max weight	300g	600g	900g	1200g	2000g	3000g	120g	200g
电压 Voltage	AC100V~240V 50HZ/60HZ							
称重精度 Weighing accuracy	0.005g		0.01g				0.001g	
密度精度 Density accuracy	0.001g/cm <sup>3</sup>						0.0001g/cm <sup>3</sup>	
密度范围 Density range	0.001-99.999g/cm <sup>3</sup>						0.0001-99.9999g/cm <sup>3</sup>	
水槽尺寸 Tank size	153×107×93mm							
机器尺寸 Machine size	425×175×325mm							
重量 Weight	4.5KG							



**Yihu! Casting®**

**艺辉铸造科技有限公司**  
Yihui Casting Technology Co.,Ltd

2026.01

📍 广东省广州市番禺区沙南路50号  
No.50, Shan'an Road, Panyu District, Guangzhou City, Guangdong Province, China  
☎ +86-20-347 34999 / 34734 666 / 8487 1666  
☎ +86-20-8487 2122  
✉ info@yihuicasting.com  
🌐 yihuicasting.com yihuicasting.cn



浏览官网



Browse Website